

15-494/694: Cognitive Robotics

Dave Touretzky

Lecture 9:

Path Planning with
Rapidly-exploring
Random Trees

Navigating with the Pilot

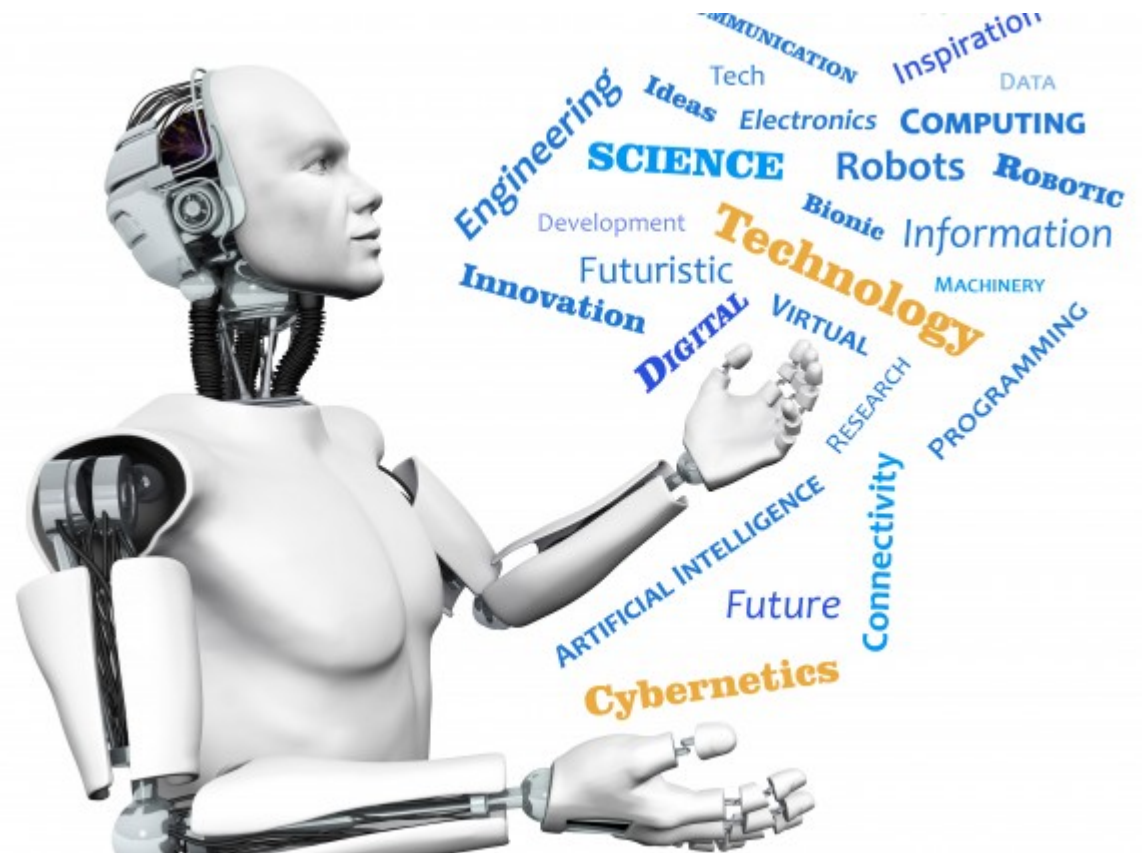

Outline

- How is path planning used in robotics?
- Path planning as state space search
- RRTs: Rapidly-exploring Random Trees
- The RRT-Connect algorithm
- Collision detection
- Smoothing
- Path planning with constraints
- Navigating with the Pilot

Path Planning in Robotics

1. Navigation path planning

- How to get from the robot's current location to a goal.
- Avoid obstacles.
- Provide for localization.

2. Manipulation path planning

- Move an arm to grasp and manipulate an object.
- Avoid obstacles.
- Obey constraints (e.g., don't spill the coffee).

Navigation Planning

- 2D state space: (x,y) coordinates of the robot
 - Treat the robot as a point or a circle.

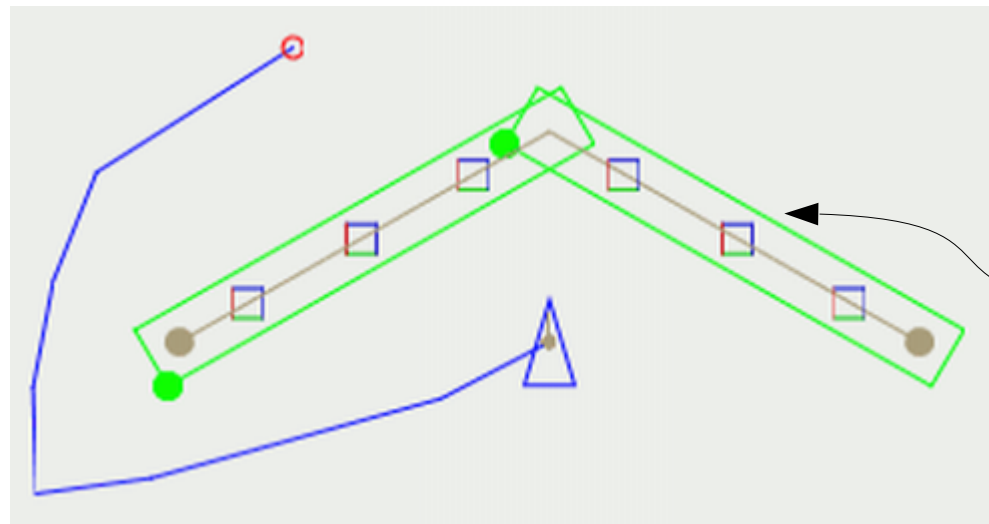

Obstacle
inflation

- 3D state space: (x,y,θ) pose of the robot
 - Heading matters when the robot is asymmetric
 - Heading matters when the robot's motion is constrained

Grid-Based Path Planning

- Discretizes the environment into a 2D grid.
- Wavefront algorithm: propagate from the start location.
- Can also use best-first or A* search.
- Works okay in small spaces.

But it has its drawbacks:

- Treats the robot as a point. Unrealistic!
- Not efficient in higher dimensional state spaces.

Wavefront Algorithm

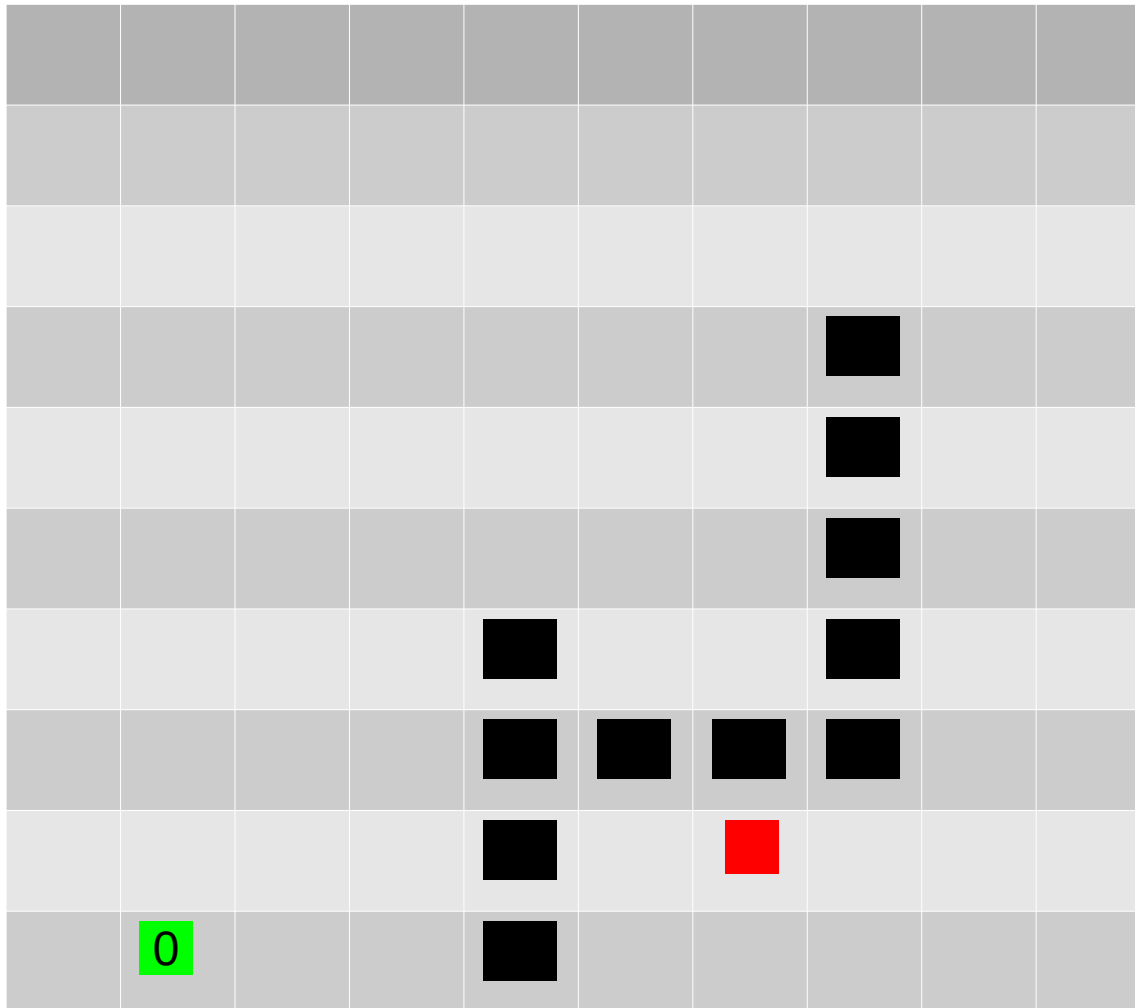

Wavefront Algorithm

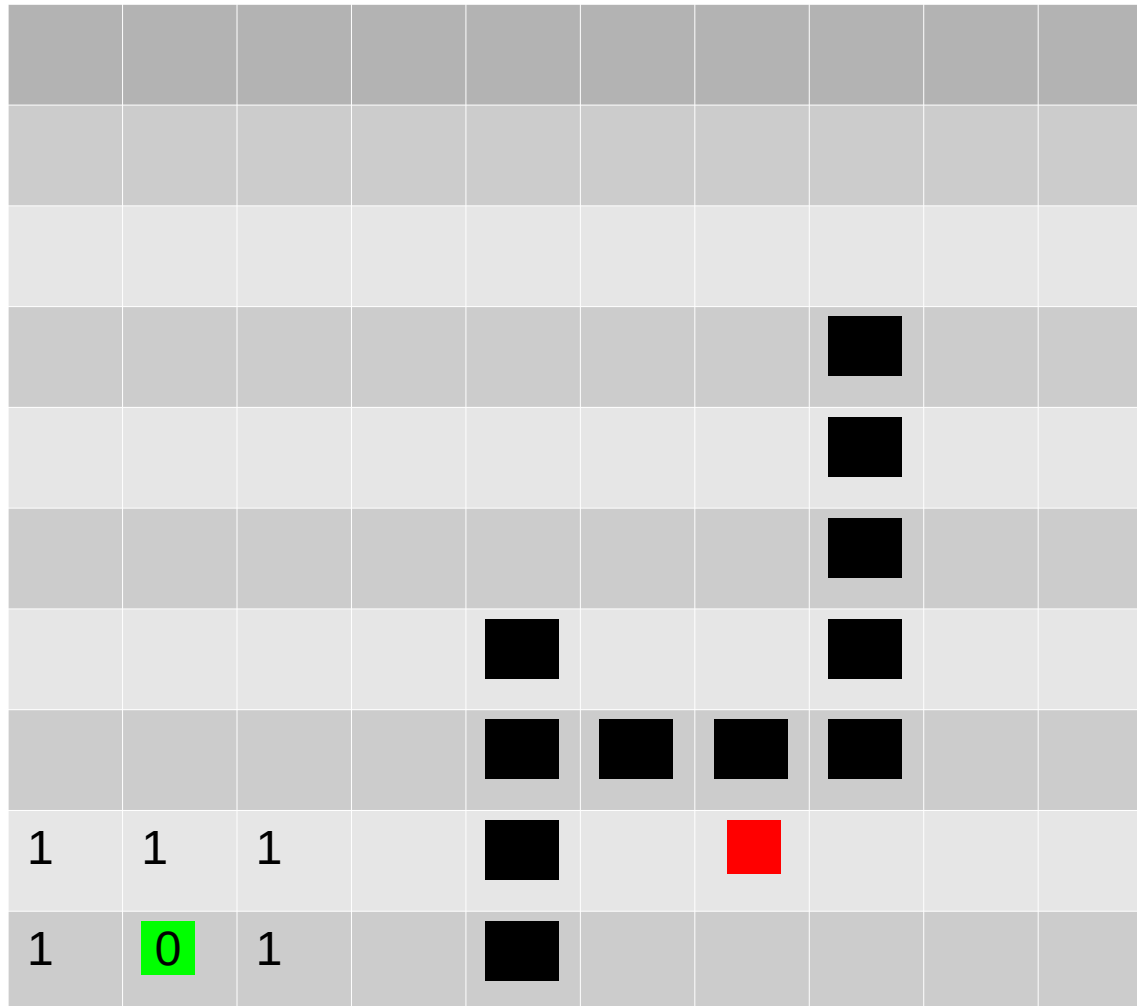

Wavefront Algorithm

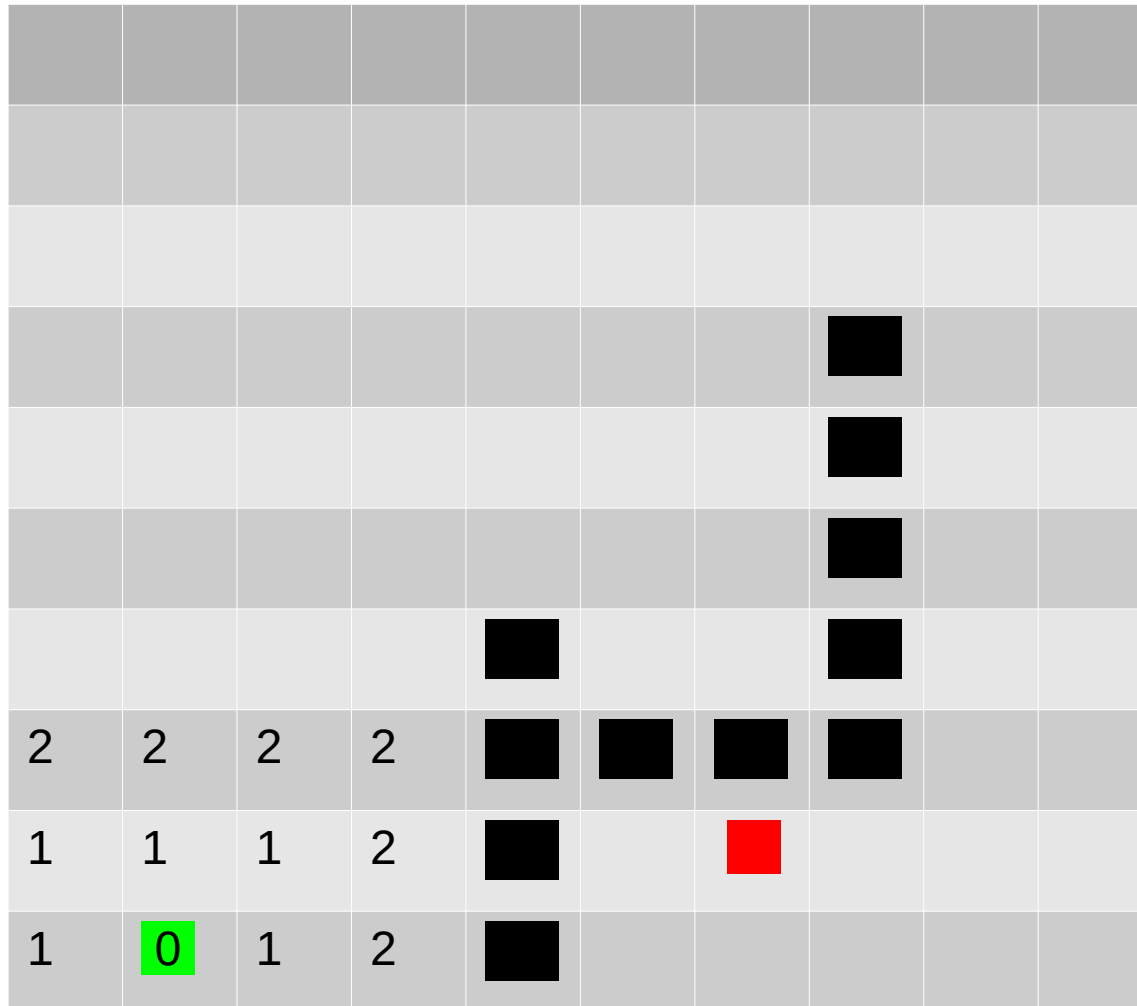

Wavefront Algorithm

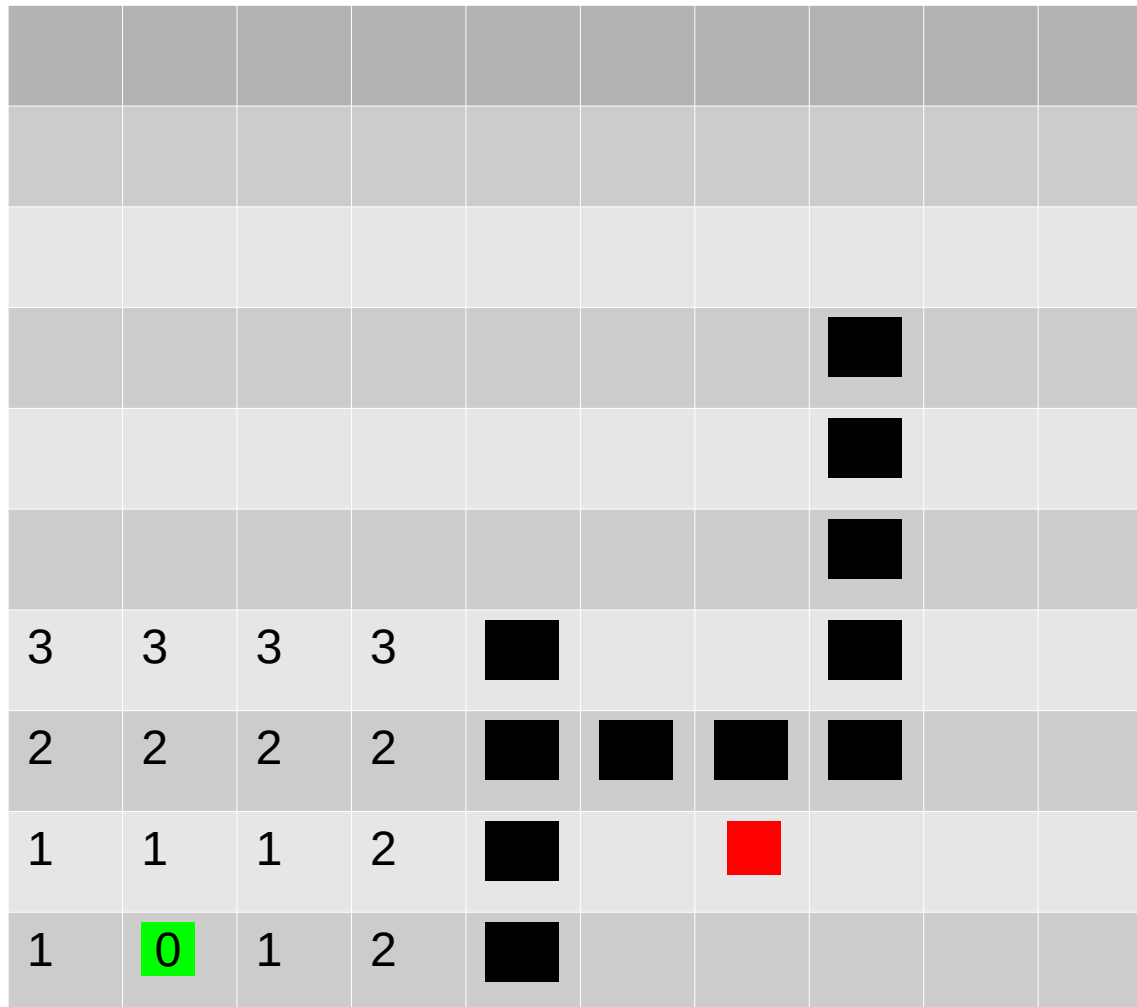

Wavefront Algorithm

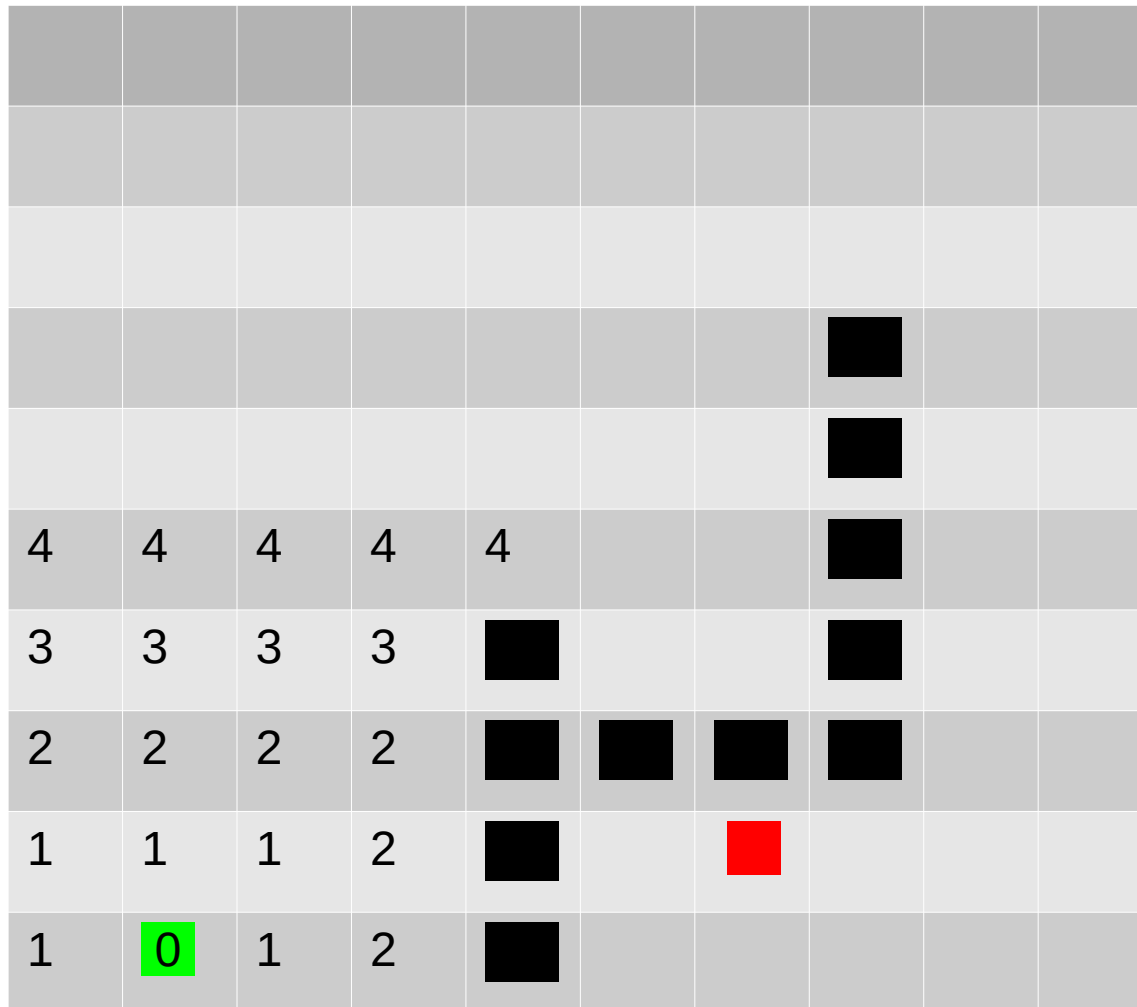

Wavefront Algorithm

9	9	9	9	9	9	9	9	9	10
8	8	8	8	8	8	8	8	9	10
7	7	7	7	7	7	7	8	9	10
6	6	6	6	6	6	7	■	9	10
5	5	5	5	5	6	7	■	10	10
4	4	4	4	■	6	7	■	11	11
3	3	3	3	■	7	7	■	12	12
2	2	2	2	■	■	■	■	13	13
1	1	1	2	■		15	14	14	14
1	0	1	2	■		15	15	15	15

Wavefront Algorithm

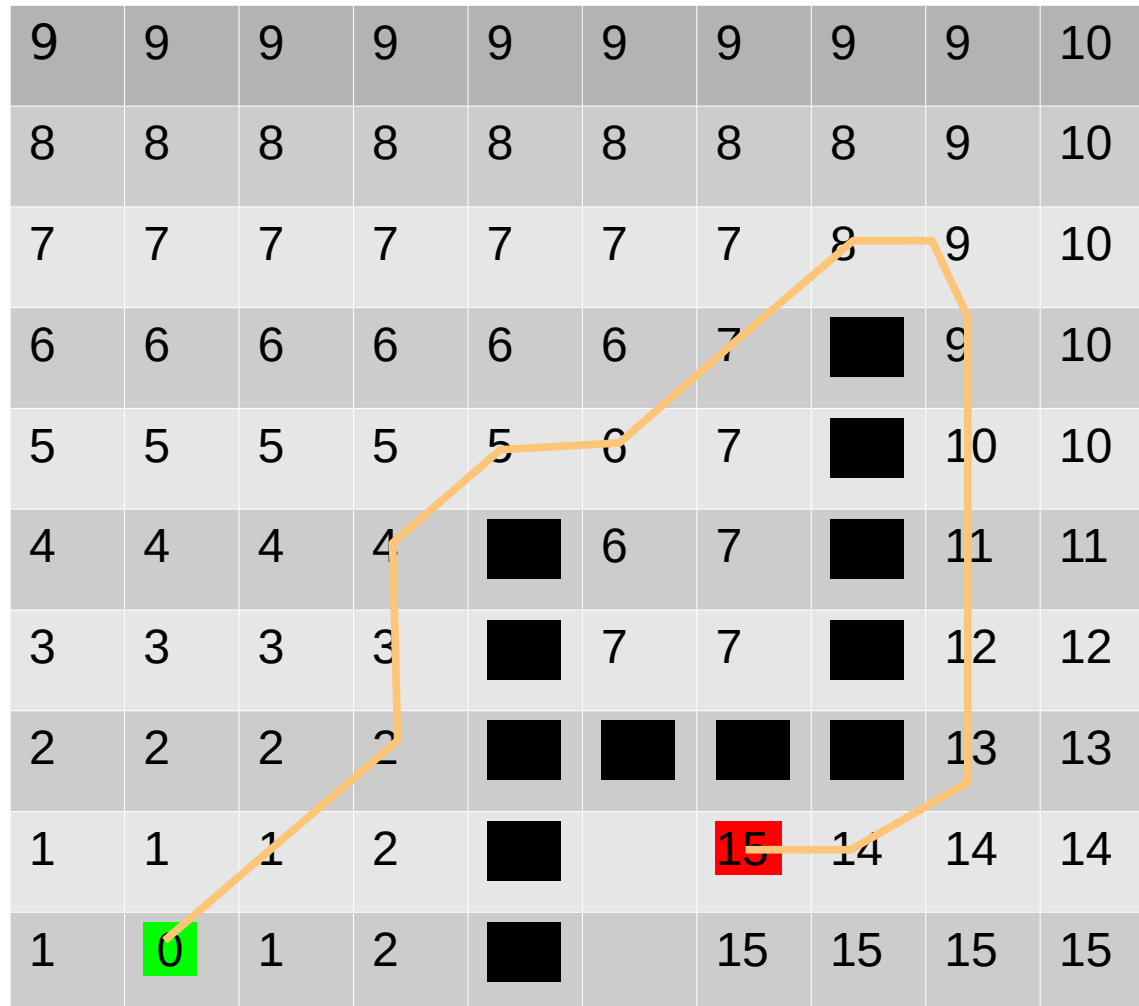

Best-First or A* Search

- Works okay in small spaces.

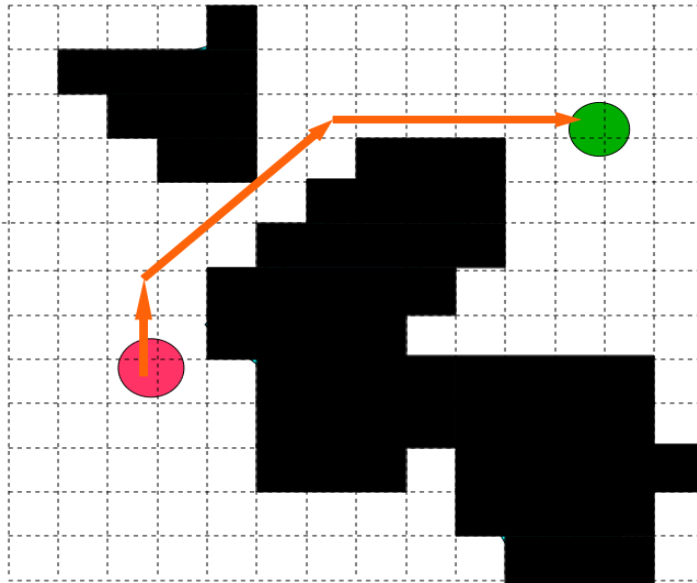

Figure from
http://www.gamasutra.com/blogs/MattKlingensmith/20130907/199787/Overview_of_Motion_Planning.php

Same drawbacks as wavefront:

- Treats the robot as a point. Unrealistic!
- Not efficient in higher dimensional state spaces.

Best-First or A* Search Can Be Slow

- Can get trapped in a cul de sac for a long time.

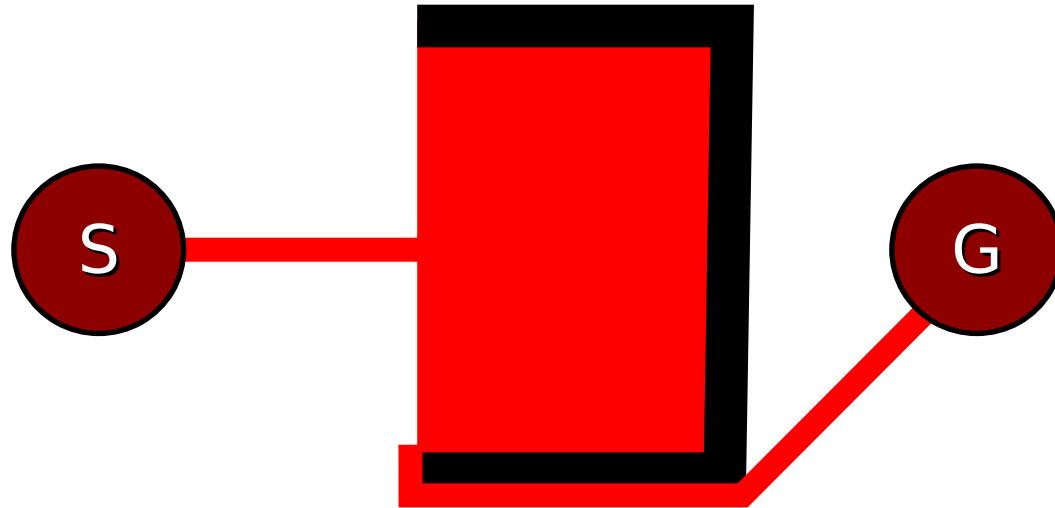

- See search animation videos on YouTube.
- Random search might be faster.

Potential Field Path Planning

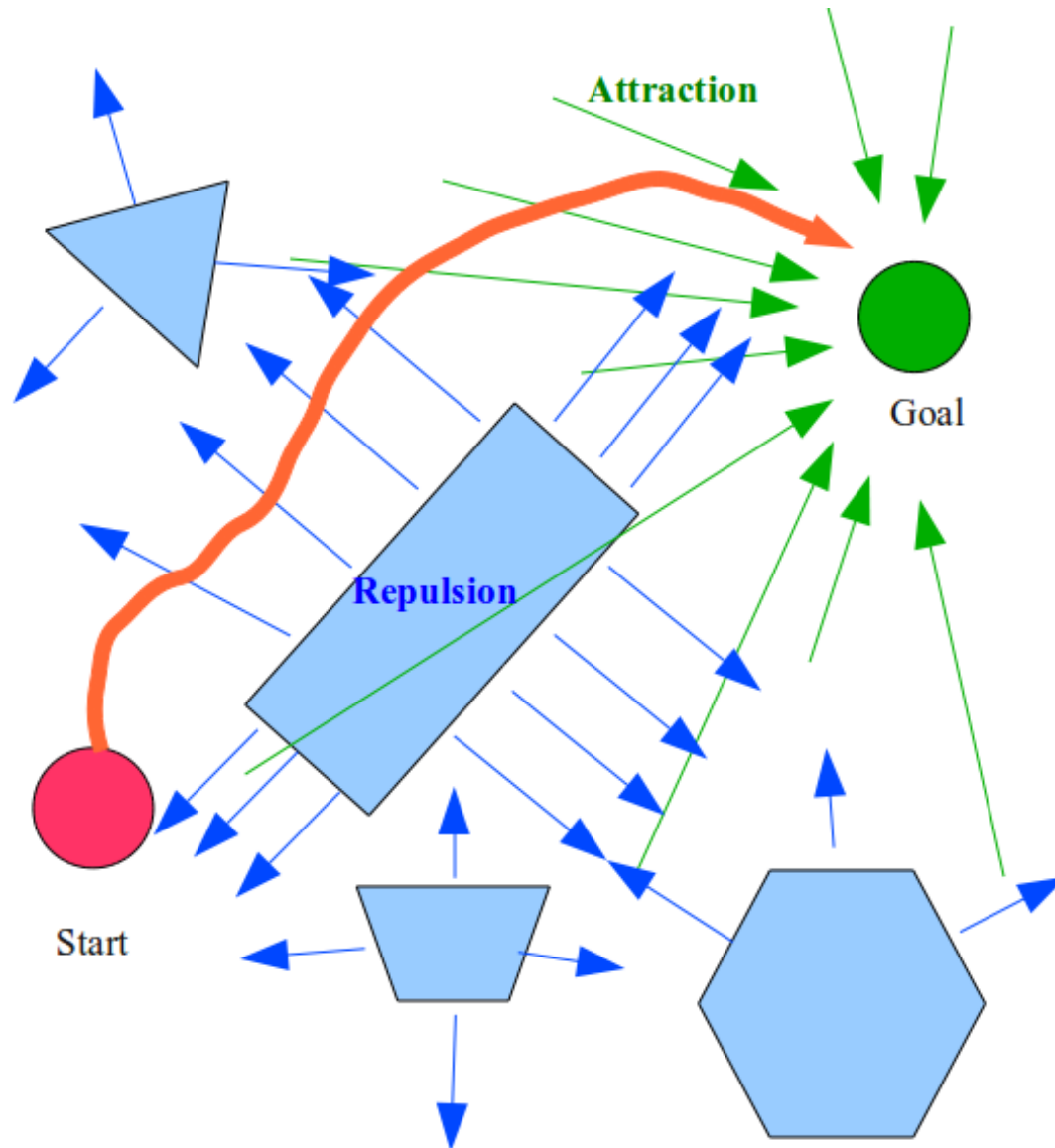

- Can fail due to local minima in the potential function.
- Consider a U-shaped obstacle.
- Requires careful tuning.

Cspace Transform

- The area around an obstacle that would cause a collision with the robot.

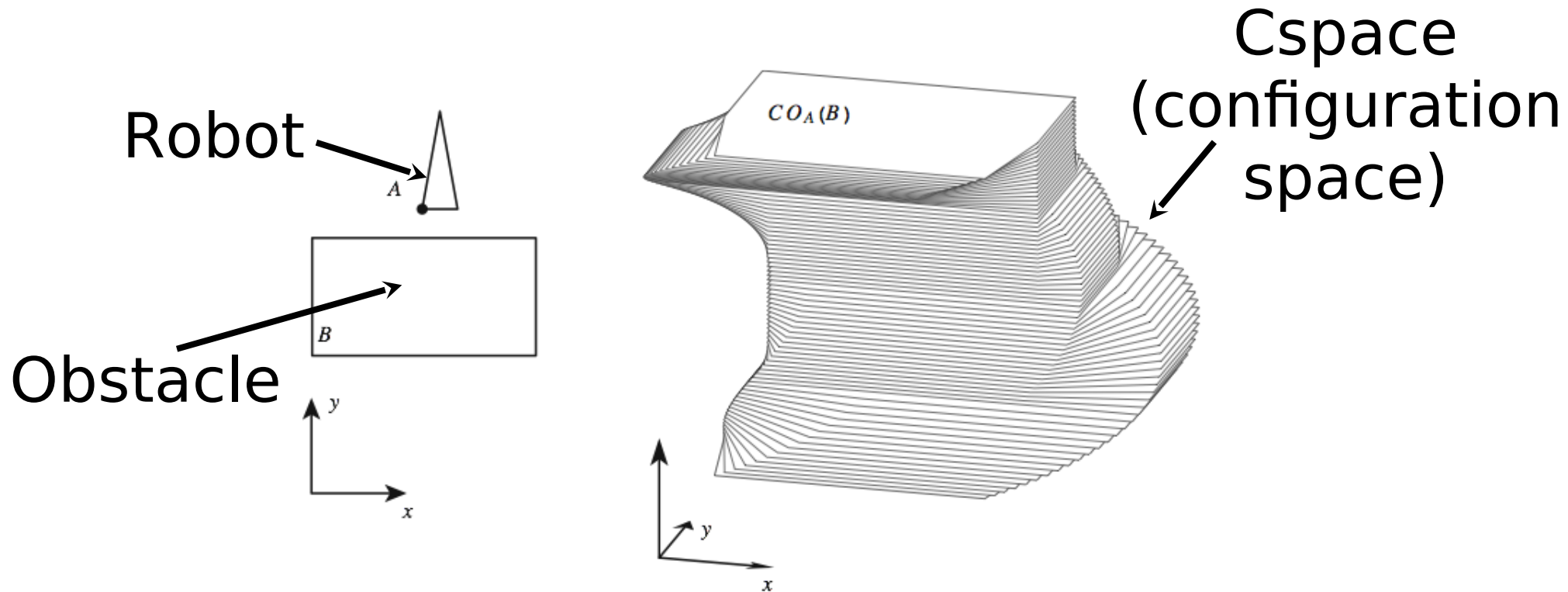

Figure 4.4 - Mason, Mechanics Of Robotic Manipulation

Arm Path Planning

- Cspace transform blocks out regions of joint space

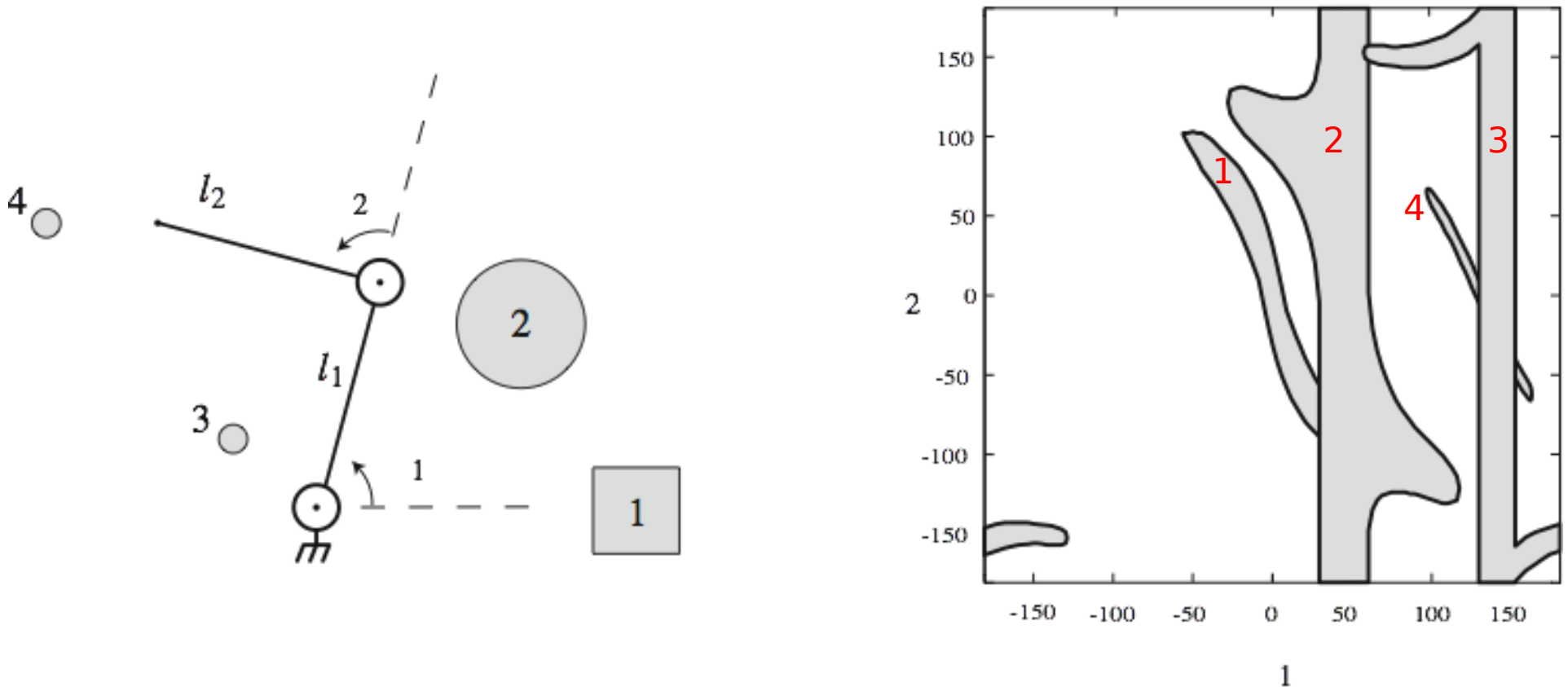

Figure 4.5 - Mason, Mechanics Of Robotic Manipulation

State Space Search

The path planning problem:

Given an n-dimensional state space and

- a start state $S = \langle s_1, s_2, \dots, s_n \rangle$
- a goal state $G = \langle g_1, g_2, \dots, g_n \rangle$
- an admissibility predicate P (collision test + constraints)

find a path from S to G such that every state on the path satisfies P .

Rapidly-exploring Random Trees

- Described in LaValle (1998), Kuffner & LaValle (2000)
- Create a tree with initial state S as the root.
- Repeat up to K times:

Pick a point \mathbf{q}_{rand} in configuration space:

- Sometimes \mathbf{q}_{rand} is really random
- Sometimes \mathbf{q}_{rand} is the goal G
- Find $\mathbf{q}_{\text{nearest}}$, the closest node to \mathbf{q}_{rand}
- Add a new node \mathbf{q}_{new} by extending $\mathbf{q}_{\text{nearest}}$ some distance Δ toward \mathbf{q}_{rand} .
- If \mathbf{q}_{new} is close enough to the goal G , return.

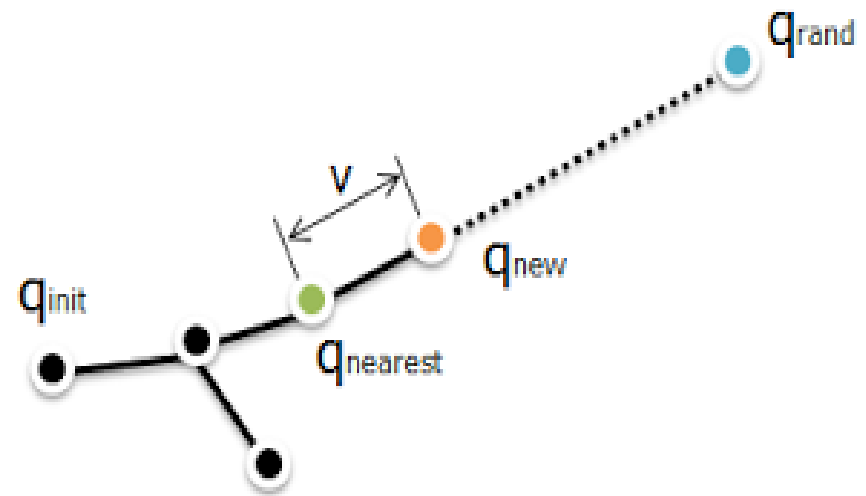
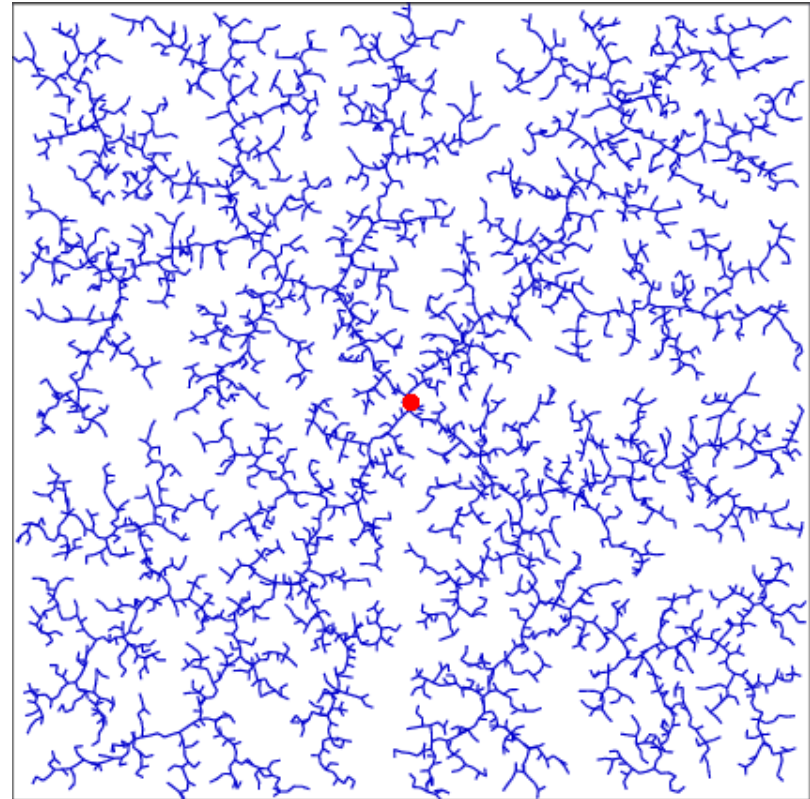

Image from
<http://joonlecture.blogspot.com/2011/02/improving-optimality-of-rrt-rrt.html>

RRT Algorithm

- Rapidly samples the state space.
- Cannot get trapped in local minima.
- Works well in high-dimensional spaces.
- Does not generate smooth paths.
- Can't tell when no solution exists; only quits when it exceeds the iteration limit K .



<http://msl.cs.uiuc.edu/rrt/treemovie.gif>

RRTs for Arm Path Planning

- Each node encodes an arm configuration in joint space.
- Only add nodes that don't cause collisions (with self or obstacles).
- Alternately (i) extend the tree in random directions and (ii) move toward the goal.

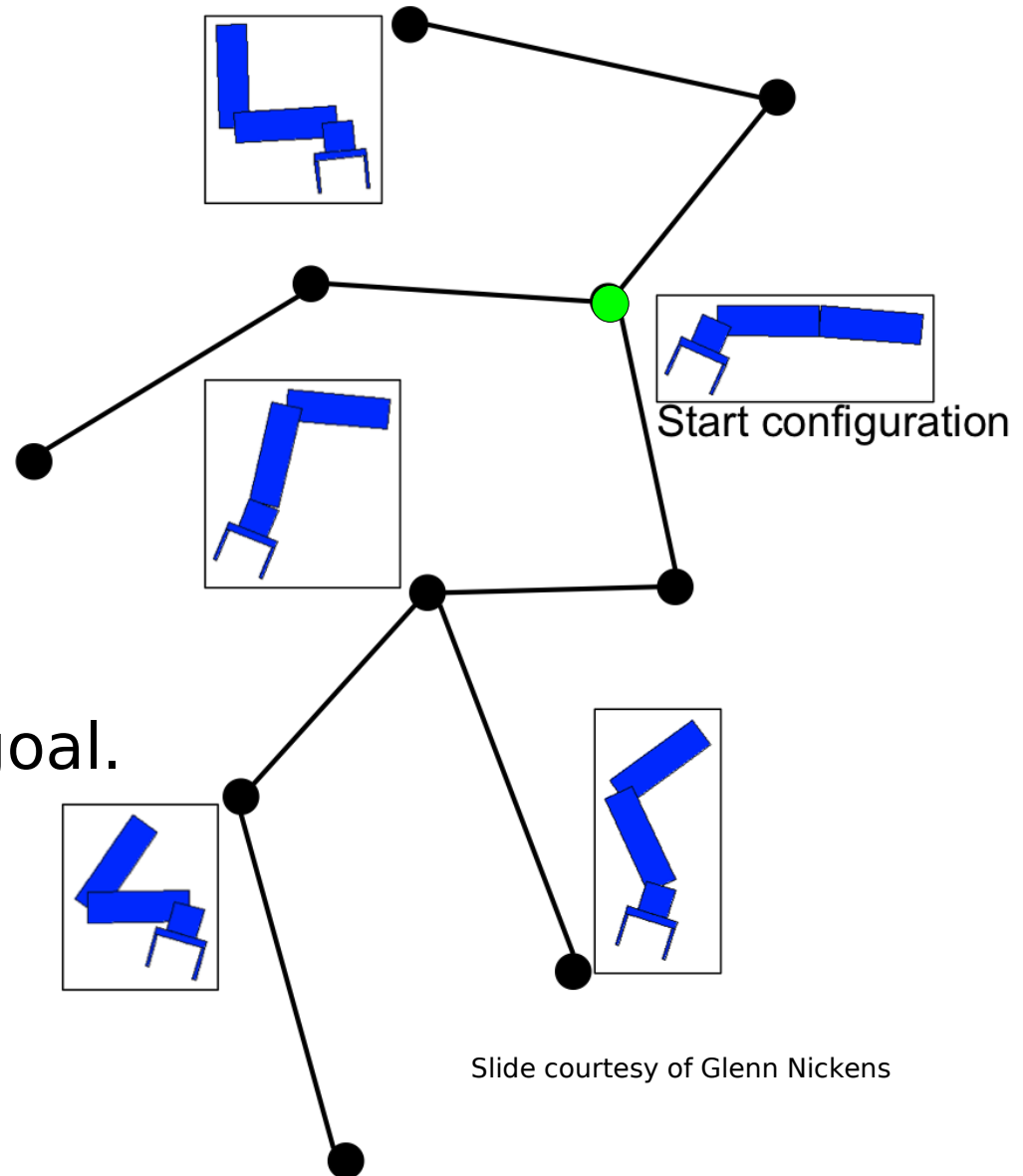

Slide courtesy of Glenn Nickens

Implementation Notes

- Finding $\mathbf{q}_{\text{nearest}}$, the nearest node in the tree to \mathbf{q}_{rand} , is the most expensive part of the algorithm.
 - Use K-D trees to efficiently find $\mathbf{q}_{\text{nearest}}$?
 - In practice, K-D trees are slower unless you have a huge number of nodes (several thousand).
- Why only go a distance Δ toward the goal state G ? Why not go as far as we can, in steps of Δ ?
 - With no obstacles, this reaches the goal very quickly, but random search will get there nearly as quickly as we keep extending the nearest node to the goal.
 - But when obstacles are present, this can waste time filling out branches that will ultimately fail.
 - Generating lots of extra nodes bloats the tree, which slows down the algorithm.

RRT-Connect Algorithm

- Variant of RRT that grows two trees:
 - one from the start state toward the goal
 - one from the goal state toward the start

- When the two trees connect, a solution has been found.

- Not guaranteed to be better than RRT, but often helps.

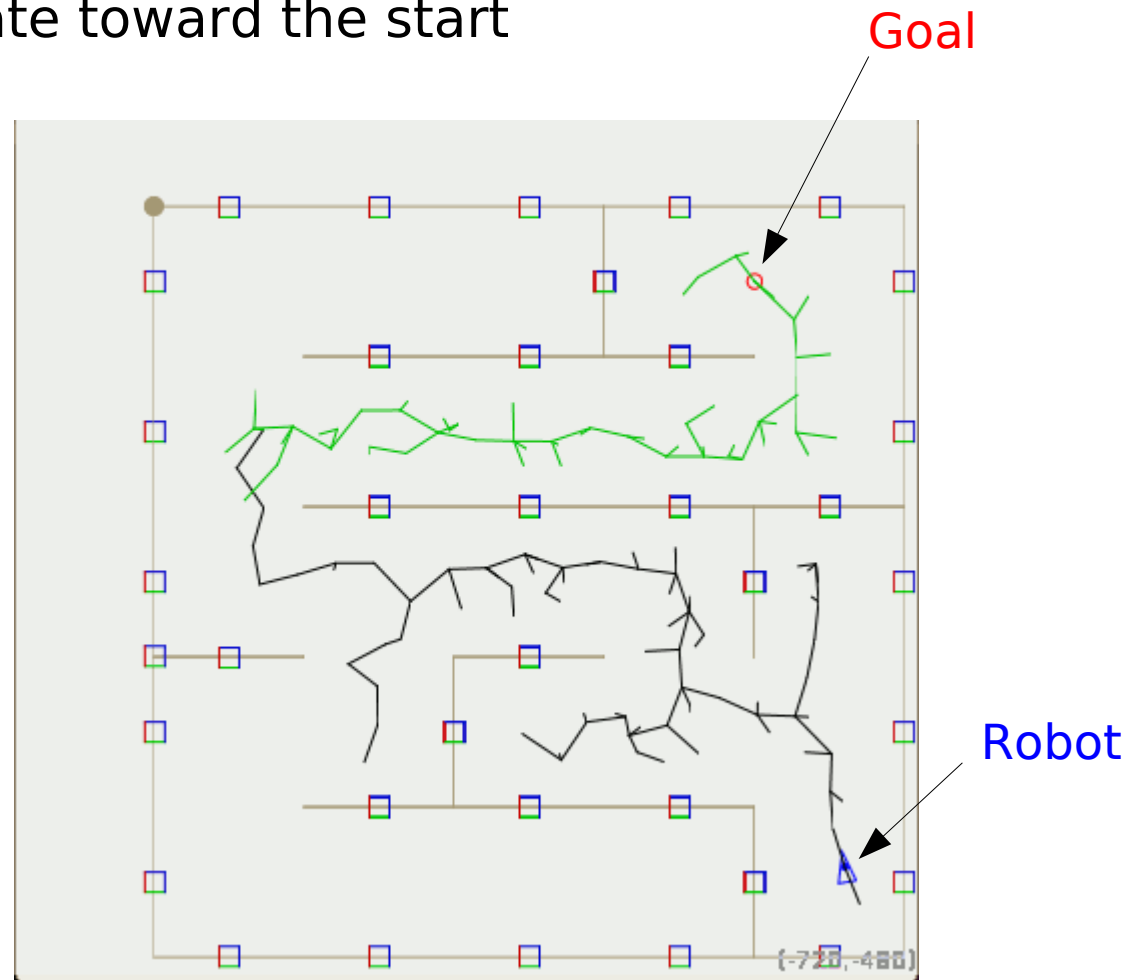

RRTs in An Open Field

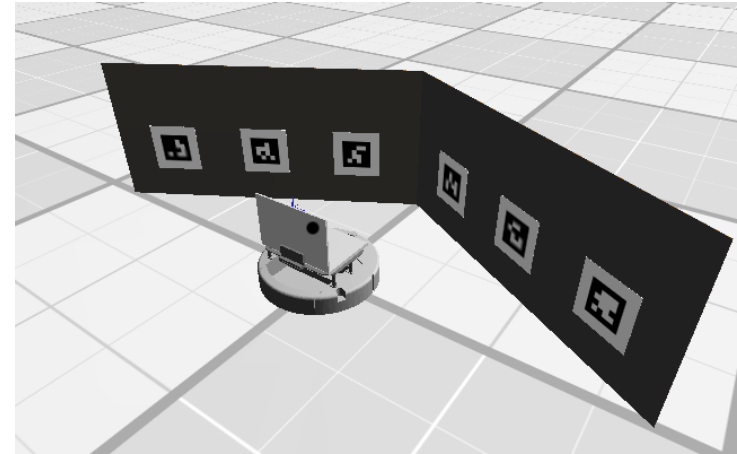
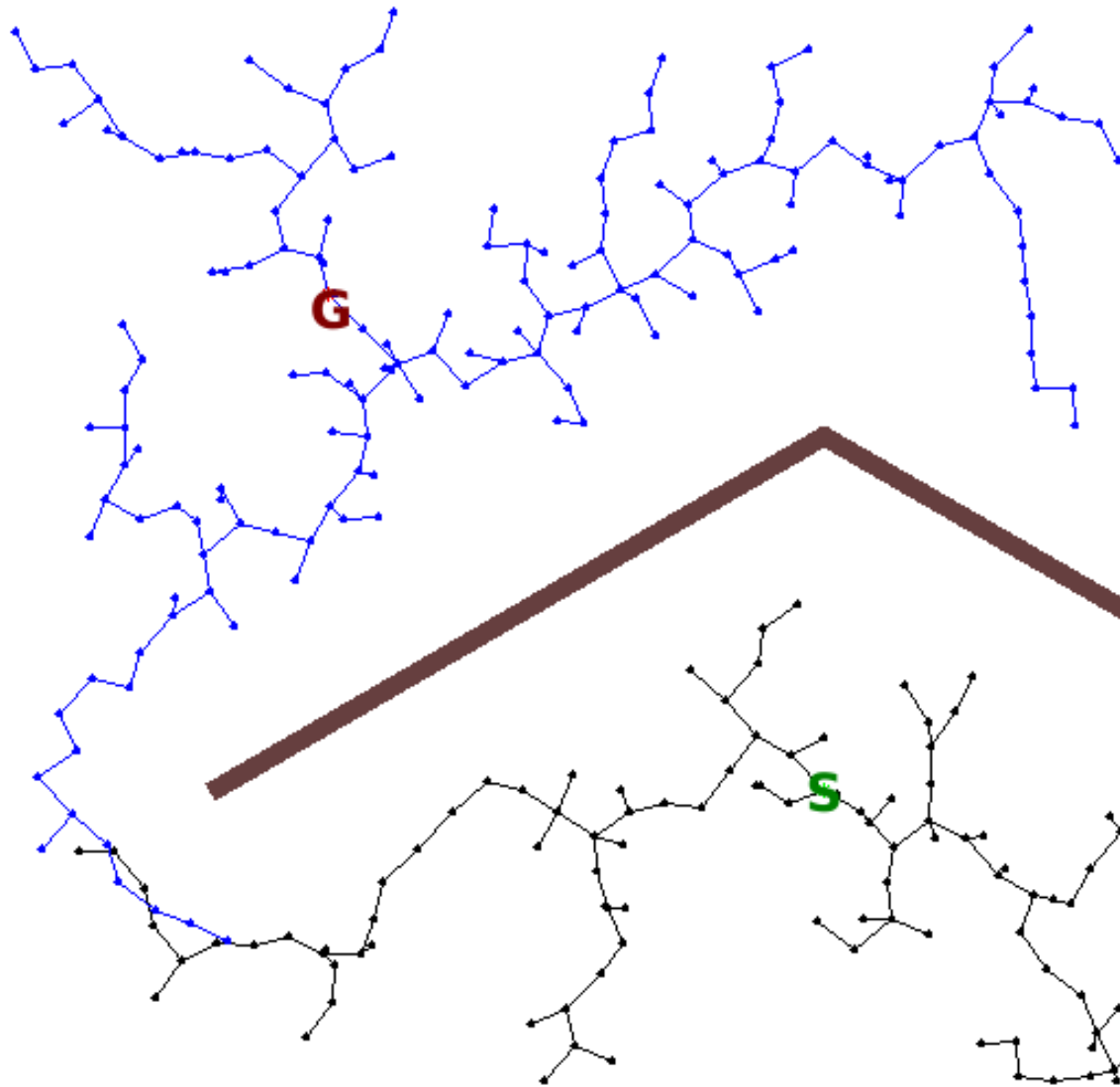

RRT-Connect For Arms

- Use IK to calculate the goal configuration.
- Use FK to calculate arm configurations for collision detection.

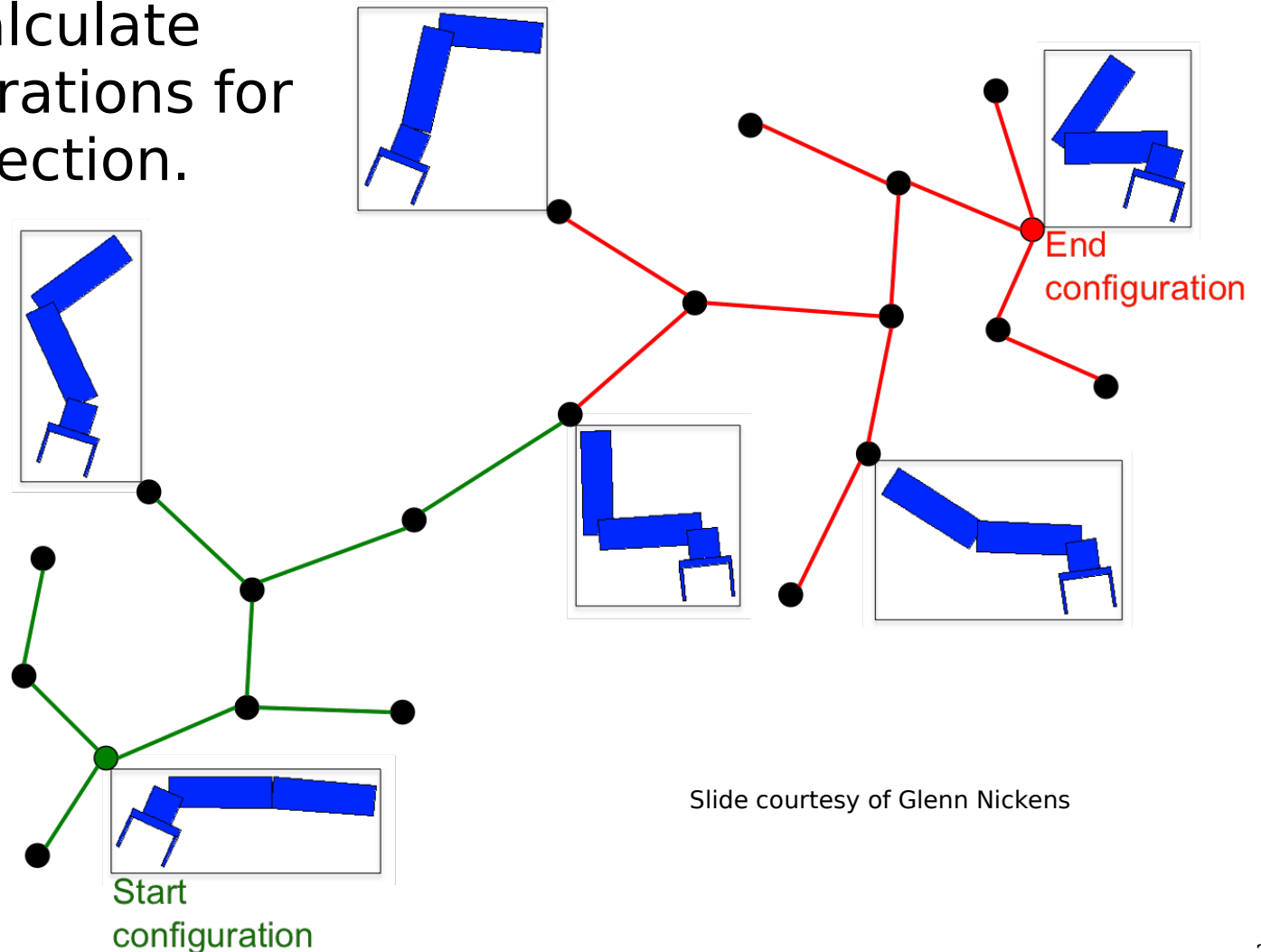
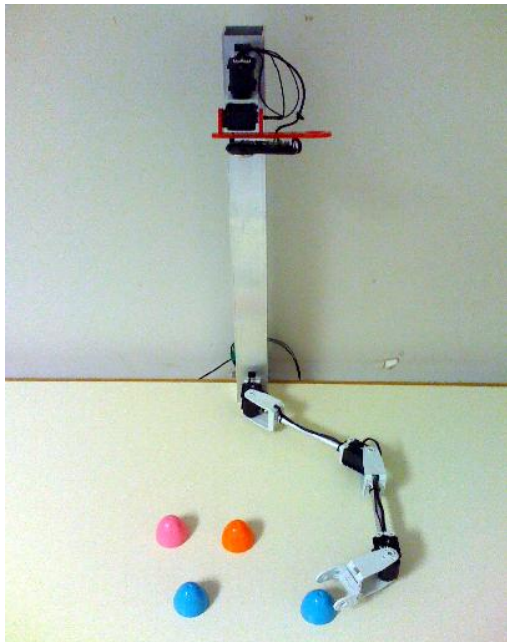

Slide courtesy of Glenn Nickens

Collision Detection

- Represent the robot and the obstacles as **convex polygons**.
- In 2D, use the Separating Axis Theorem to check for collisions.
 - Easy to code
 - Fast to compute
- In 3D, things get more complex.
 - Tekkotsu uses the GJK (Gilbert-Johnson-Keerthi) algorithm, used in many physics engines for video games.

Algorithm to Apply the SAT

- For every edge of polygon A and of polygon B:
 - Project all the vertices onto the line normal to that edge.
 - Calculate the min and max coordinates for each polygon
 - If $\min A < \min B$ and $\max A > \min B$ OR
if $\min B < \min A$ and $\max B > \min A$
then the polygons collide.
- If you find any edge projection in which the ranges don't overlap, the polygons do not collide.

Separating Axis Theorem

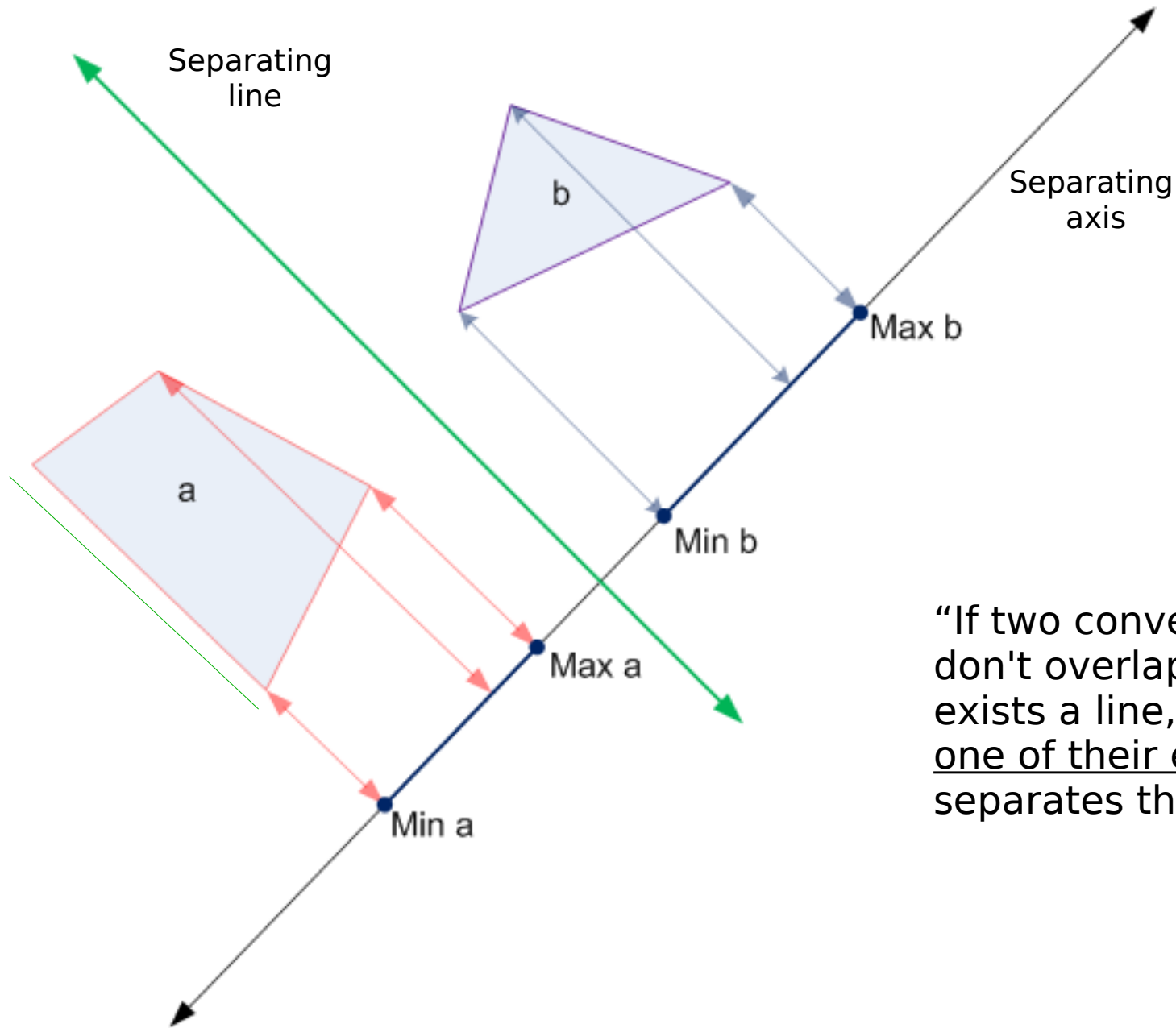

“If two convex polygons don't overlap, then there exists a line, parallel to one of their edges that separates them.”

Separating Axis Theorem

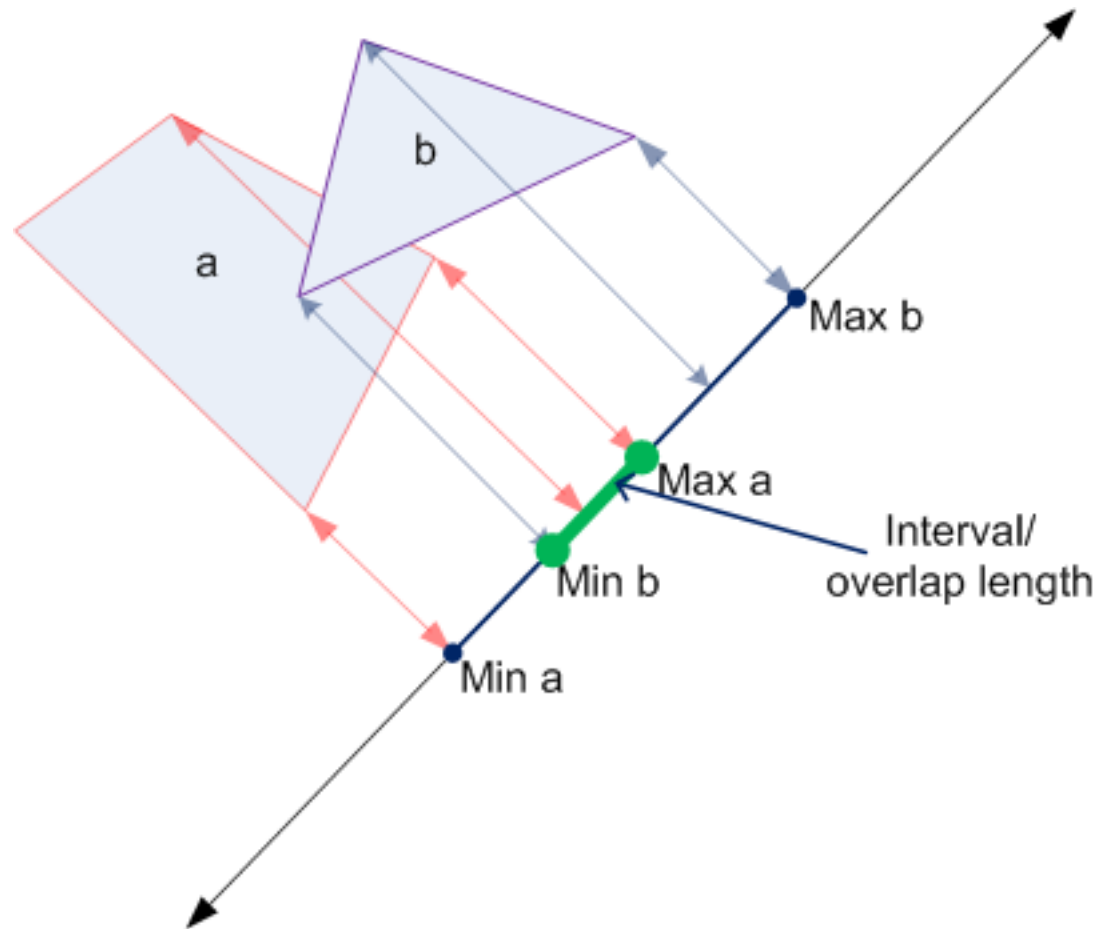

Arm Collision Detection

- Represent each link as a separate polygon.
- Check for:
 - Self-collisions other than link n with link $n+1$
 - Collisions of a link with an obstacle

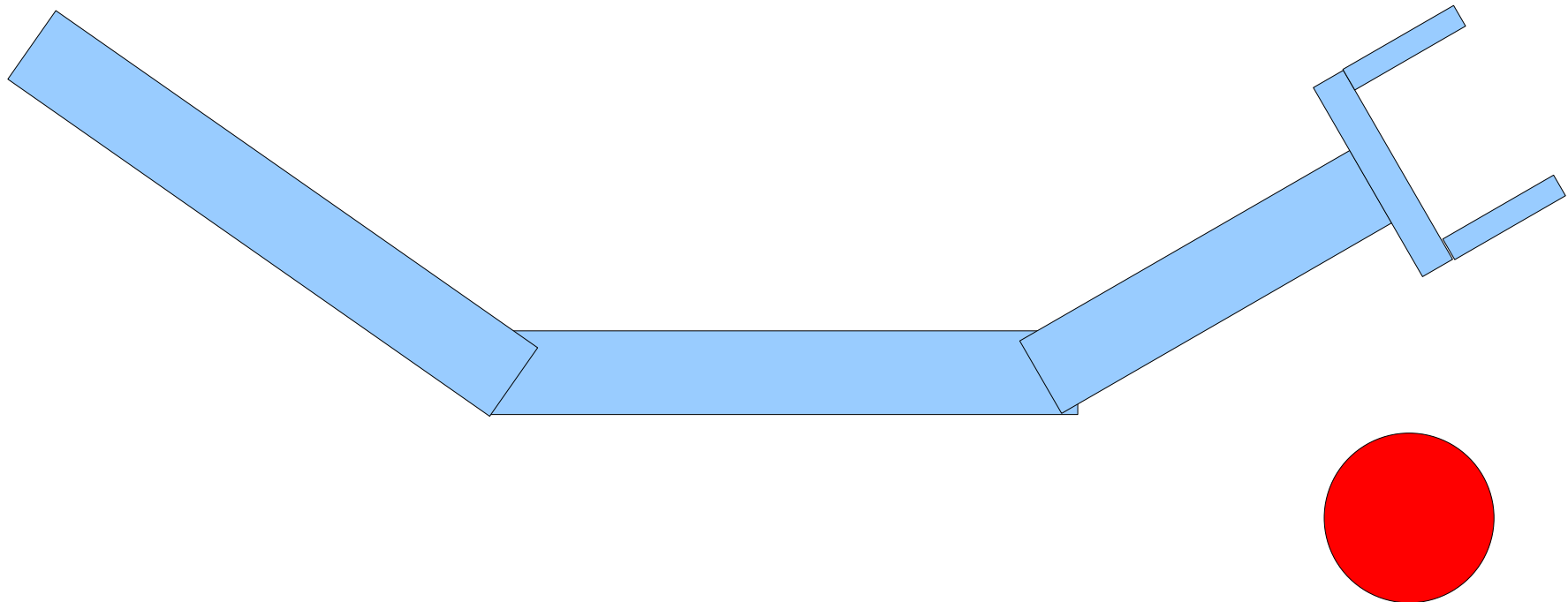

Path Smoothing

- The random component of RRT-Connect search often results in a jerky and meandering solution.
- Solution: apply a path smoothing algorithm.
- Repeat N times:
 - Pick two points on the path at random
 - See if we can linearly interpolate between those points without collisions.
 - If so, then snip out that segment of the path.

Smoothing An Arm Trajectory

- Start state
- Intermed. states
- End state

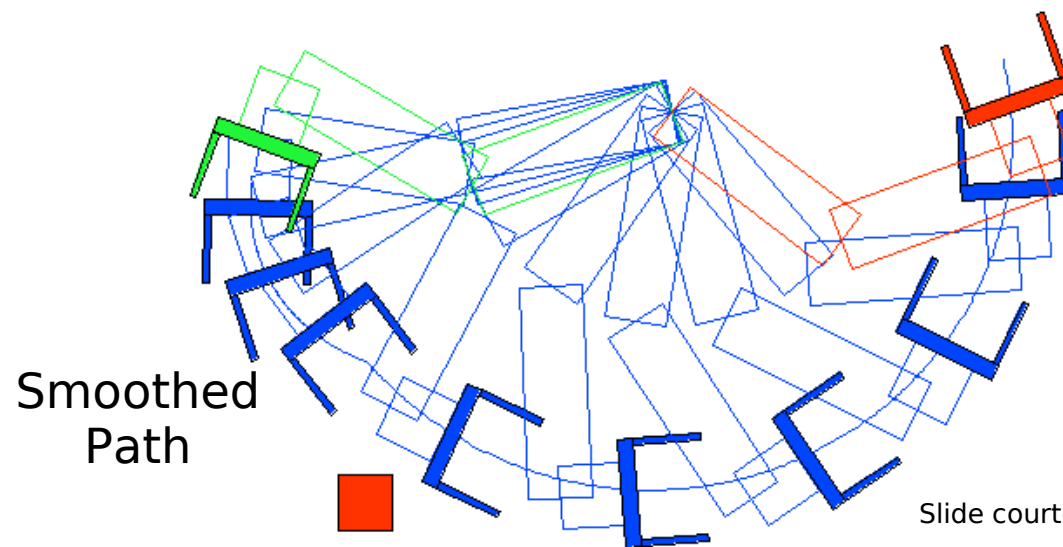
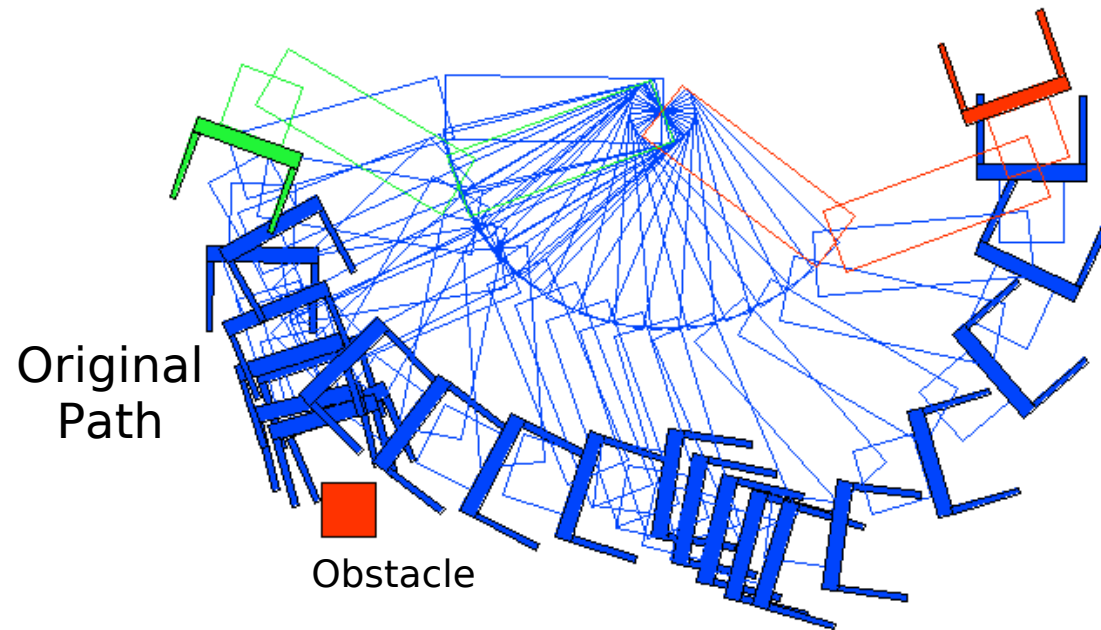

Slide courtesy of Glenn Nickens

Path Planning With Constraints

- With no closeable fingers, arm motion is constrained to be within about 60° of finger direction or we'll lose the object.

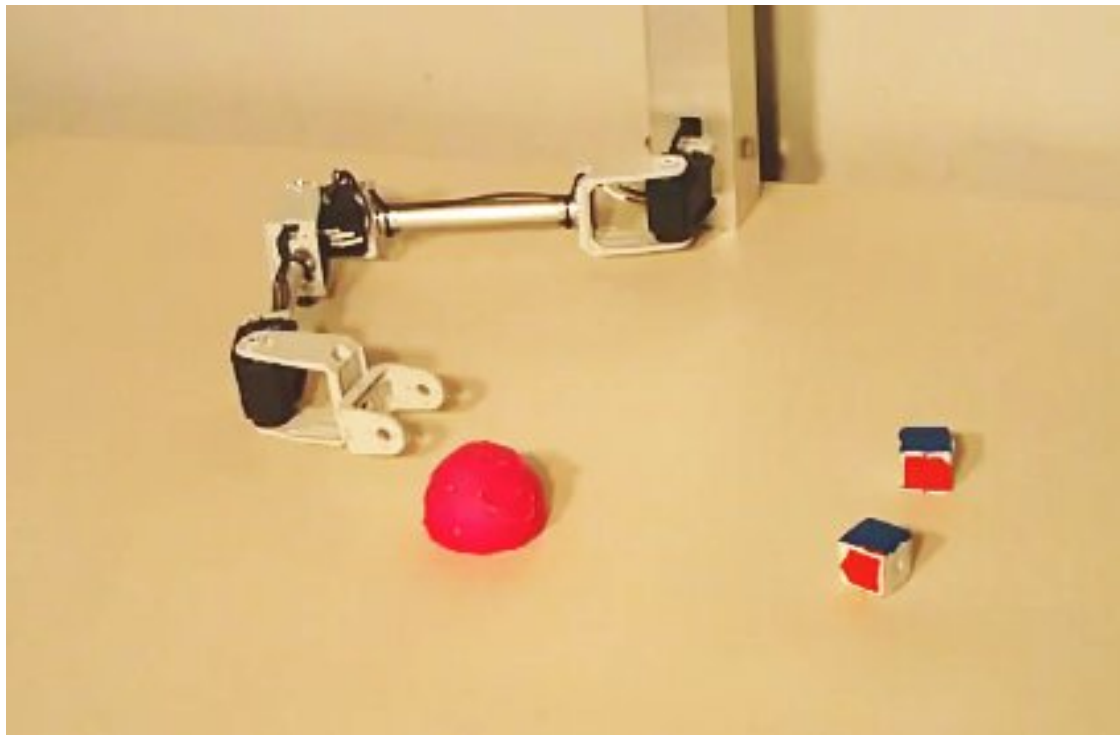

(video)

<http://www.youtube.com/watch?v=9oDQ754YVoc>

Implementing Constraints

- Each time we generate a new state \mathbf{q}_{new} :
 - Check to see if \mathbf{q}_{new} obeys the constraint.
 - For finger motion constraint, check if the direction of motion from parent state $\mathbf{q}_{\text{nearest}}$ to new state \mathbf{q}_{new} is **within 60°** of the finger direction.
- What if \mathbf{q}_{new} doesn't obey the constraint?
 - Reject it and pick a new \mathbf{q}_{rand} from which we'll generate a new \mathbf{q}_{new} .
 - Or try to “fix” \mathbf{q}_{new} by perturbing its value slightly so as to satisfy the constraint.

Path Planning Failure

RRT path planning can legitimately fail if:

- There is no route to the goal due to obstacles blocking every path from start to goal.
- The paths to the goal don't lie entirely within the allowed world bounds (world map too small).

But it can also fail if:

- The iteration limit was set too low.
- The start state is already in collision with something.
- The goal state is in collision with something.

Running Out of Iterations

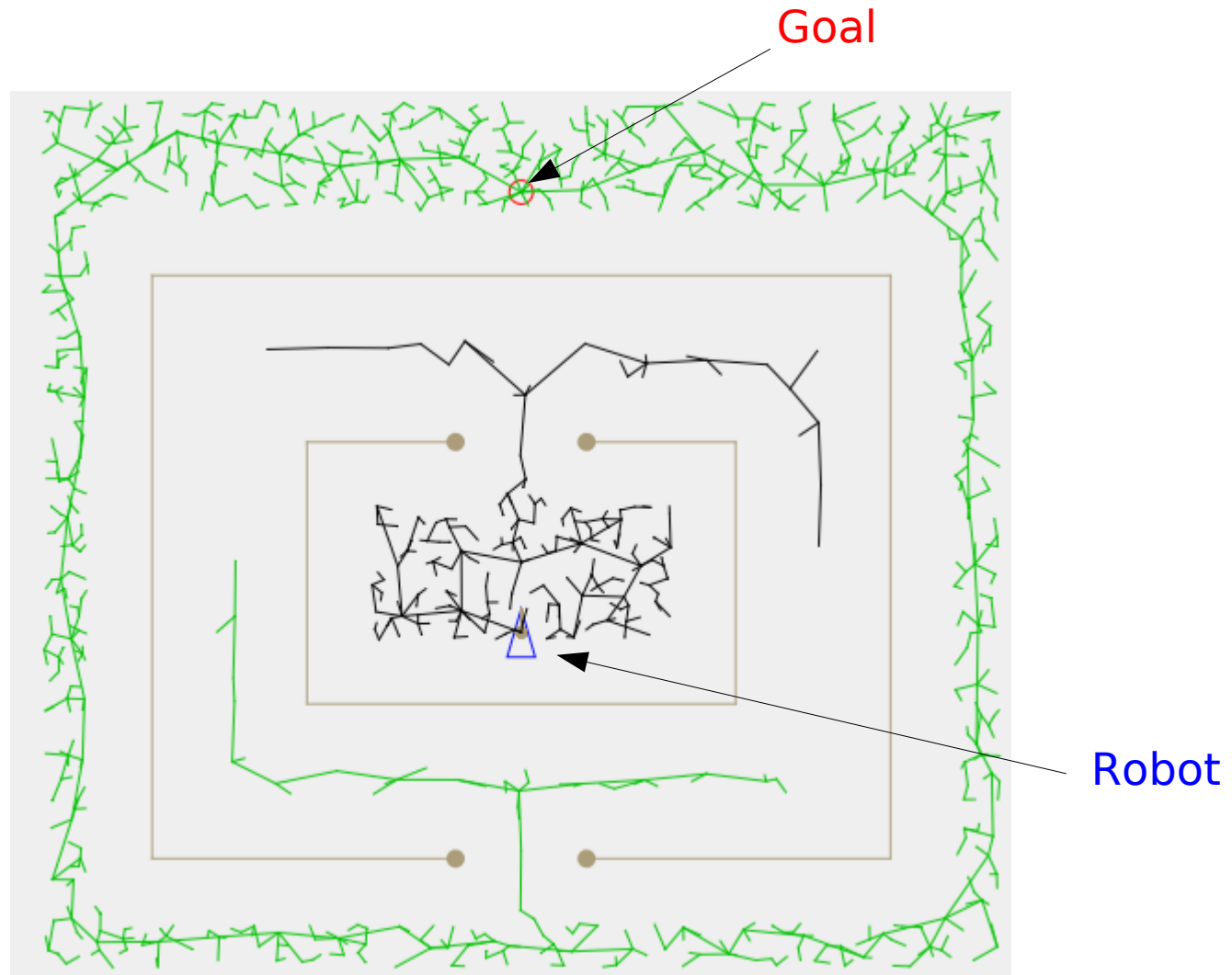

Path Planning Failure: Goal State Is In Collision

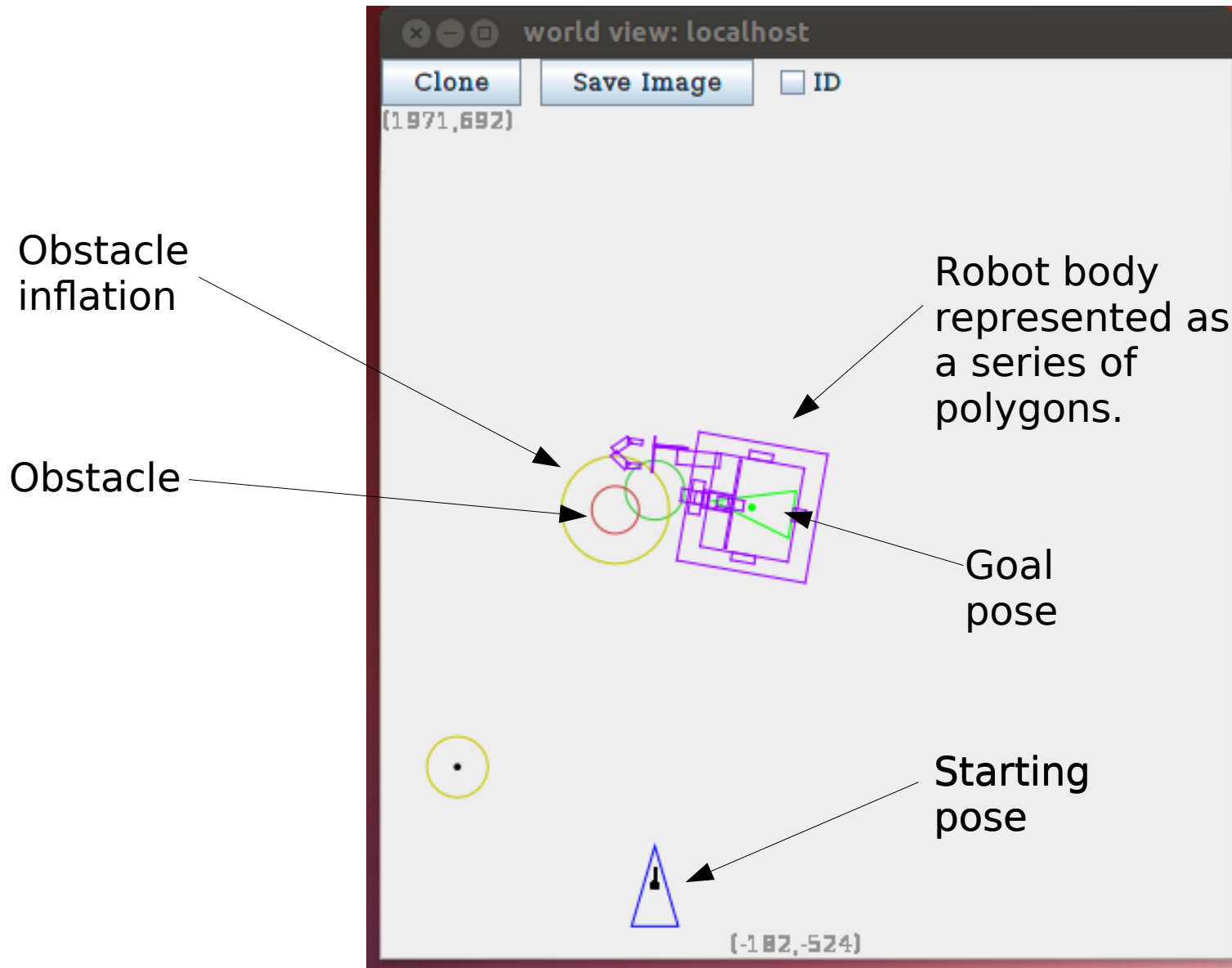

Full 3D Path Planning: The Piano Movers Problem

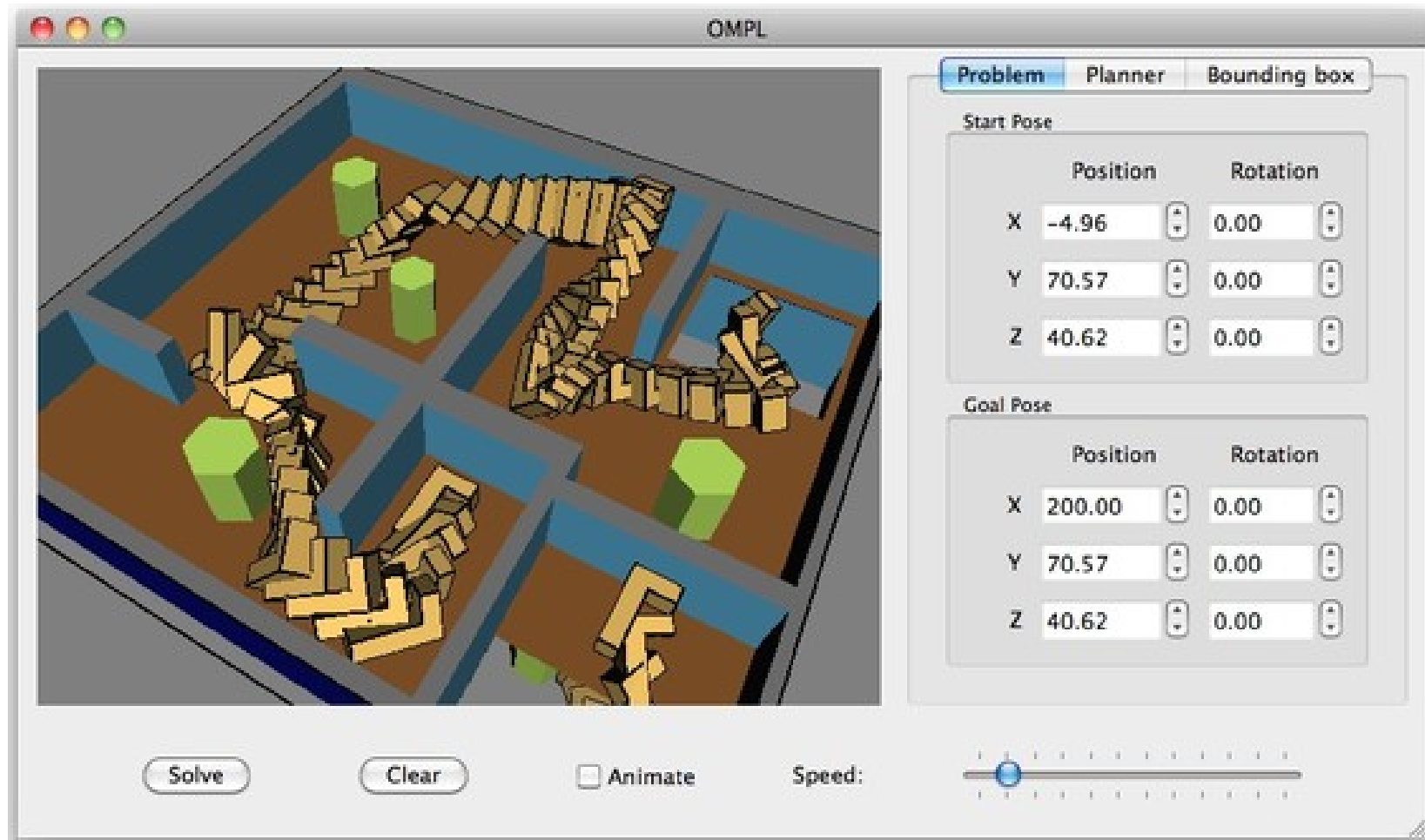

Figure from
[http://www.gamasutra.com/blogs/MattKlingensmith/
20130907/199787/Overview_of_Motion_Planning.php](http://www.gamasutra.com/blogs/MattKlingensmith/20130907/199787/Overview_of_Motion_Planning.php)

Open Motion Planning Library:
<http://ompl.kavrakilab.org>

The Pilot

- Navigation utility defined in `cozmo_fsm/pilot.fsm`
- How to go from A to B:
 - Generate obstacle list from current world map.
 - Use RRT-Connect to plan a path from A to B?
 - Good in open spaces; has trouble with doorways.
 - Formulate a navigation plan to follow the path.
 - Straight segments
 - Turns
 - Arcs
 - Landmark checks
 - Execute the navigation plan, correcting as necessary.
 - Report success or failure.

PilotToPose Node

- State node for invoking the Pilot.
- Tell it where you want to go, and (optionally) the desired heading at the destination.
- Use a heading of NaN if you don't care.
- =PILOT=> transition can check for errors.

```
go: PilotToPose(Pose(500, 0, 0, angle_z=degrees(90)))  
go =C=> Say("Success")  
go =PILOT(StartCollides)=> Say("Start collides!")
```

Path Viewer

```
PilotToPose(Pose(300, 0, 0, angle_z=degrees(90)))
```

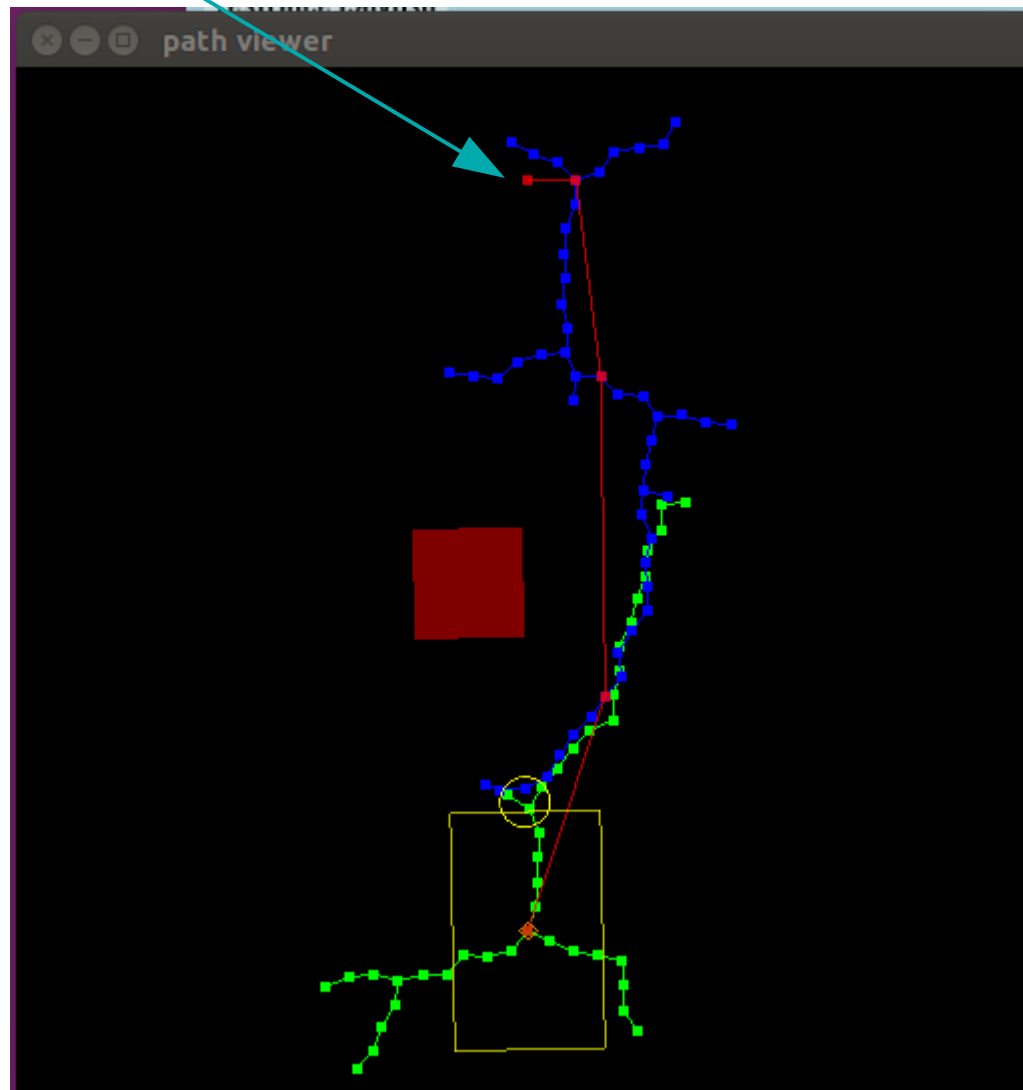

Hybrid Path-Planner

- cozmo-tools now uses a hybrid path planner.
- Check for StartCollides condition and use RRT to find a maneuver that disengages from the obstacle, e.g., move away from a wall.
- Wavefront algorithm finds a route to the goal using large obstacle inflation. Easily goes through doorways.
- RRT post-processing:
 - Check for collisions using actual robot shape and less inflation
 - Generate a condensed path with fewer steps
- Check for doorway crossing and insert “doorpass” steps in the navigation plan.