



From Bits through Integers

18-213/18-613

Introduction to Computer Systems

2nd Lecture, May 15, 2024

Bits, Bytes, and Integers

- **Representing information as bits**
- **Bit-level manipulations**
- **Integers**
 - Representation: unsigned and signed
 - Conversion, casting
 - Expanding, truncating
 - Addition, negation, multiplication, shifting
- **Byte Ordering**

Analog Computers

- Before digital computers there were analog computers.
- Consider a couple of simple analog computers:
 - A simple circuit can allow one to adjust voltages using variable resistors and measure the output using a volt meter:
 - A simple network of adjustable parallel resistors can allow one to find the average of the inputs.

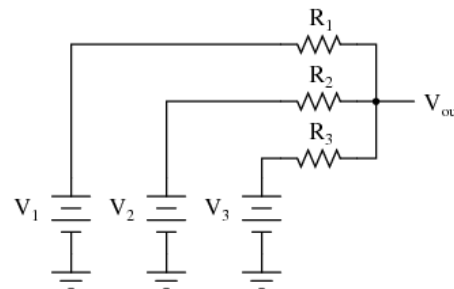
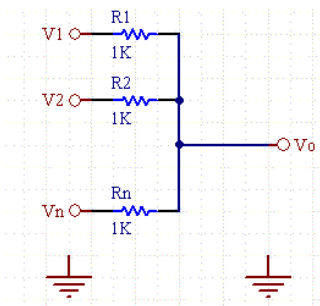

<https://www.daycounter.com/Calculators/Voltage-Summer/Voltage-Summer-Calculator.phtml>

<https://www.quora.com/What-is-the-most-basic-voltage-adder-circuit-without-a-transistor-op-amp-and-any-external-supply>

Needing Less Accuracy, Precision is Better

- **We don't try to measure exactly**
 - We just ask, is it high enough to be “On”, or
 - Is it low enough to be “Off”.
- **We have two states, so we have a binary, or 2-ary, system.**
 - We represent these states as 0 and 1
- **Now we can easily interpret, communicate, and duplicate signals well enough to know what they mean.**

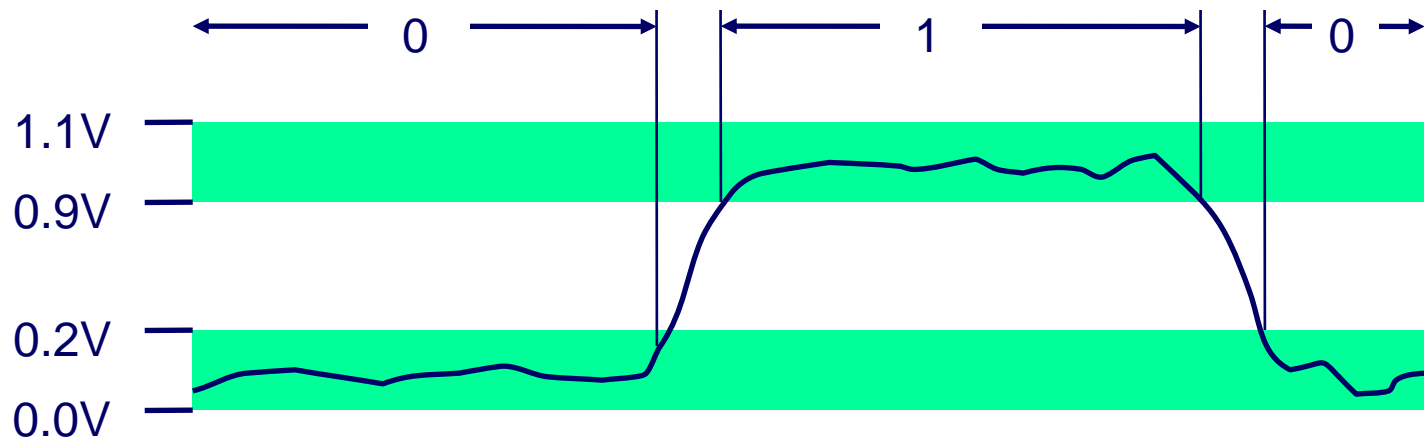

Binary Representation

- **Binary representation leads to a simple binary, i.e. base-2, numbering system**
 - 0 represents 0
 - 1 represents 1
 - Each “place” represents a power of two, exactly as each place in our usual “base 10”, 10-ary numbering system represents a power of 10
- **By encoding/interpreting sets of bits in various ways, we can represent different things:**
 - Operations to be executed by the processor, numbers, enumerable things, such as text characters
- **As long as we can assign it to a discrete number, we can represent it in binary**

Binary Representation: Simple Numbers

■ For example, we can count in binary, a base-2 numbering system

- 000, 001, 010, 011, 100, 101, 110, 111, ...
 - $000 = 0*2^2 + 0*2^1 + 0*2^0 = 0$ (in decimal)
 - $001 = 0*2^2 + 0*2^1 + 1*2^0 = 1$ (in decimal)
 - $010 = 0*2^2 + 1*2^1 + 0*2^0 = 2$ (in decimal)
 - $011 = 0*2^2 + 1*2^1 + 1*2^0 = 3$ (in decimal)
 - Etc.

■ For reference, consider some base-10 examples:

- $000 = 0*10^2 + 0*10^1 + 0*10^0$
- $001 = 0*10^2 + 0*10^1 + 1*10^0$
- $357 = 3*10^2 + 5*10^1 + 7*10^0$

Hexadecimal and Octal

- **Writing out numbers in binary takes too many digits**
- **We want a way to represent numbers more densely such that fewer digits are required**
 - But also such that it is easy to get at the bits that we want
- **Any power-of-two base provides this property**
 - Octal, e.g. base-8, and hexadecimal, e.g. base-16 are the closest to our familiar base-10.
 - Each has been used by “computer people” over time
 - Hexadecimal is often preferred because it is denser.

Hexadecimal

■ Hexadecimal 00_{16} to FF_{16}

- Base 16 number representation
- Use characters '0' to '9' and 'A' to 'F'

■ Consider $1A2B$ in Hexadecimal:

- $1 \cdot 16^3 + A \cdot 16^2 + 2 \cdot 16^1 + B \cdot 16^0$
- $1 \cdot 16^3 + 10 \cdot 16^2 + 2 \cdot 16^1 + 11 \cdot 16^0 = 6699$ (decimal)

- The C Language prefixes hexadecimal numbers with "0x" so they aren't confused with decimal numbers
- Write $FA1D37B_{16}$ in C as

- `0xFA1D37B`
- `0xfa1d37b`

18213: $\underbrace{0100}_4 \underbrace{0111}_7 \underbrace{0010}_2 \underbrace{0101}_5$

Hex	Decimal	Binary
0	0	0000
1	1	0001
2	2	0010
3	3	0011
4	4	0100
5	5	0101
6	6	0110
7	7	0111
8	8	1000
9	9	1001
A	10	1010
B	11	1011
C	12	1100
D	13	1101
E	14	1110
F	15	1111

Today: Bits, Bytes, and Integers

- Representing information as bits
- **Bit-level manipulations**
- **Integers**
 - Representation: unsigned and signed
 - Conversion, casting
 - Expanding, truncating
 - Addition, negation, multiplication, shifting
- **Byte Ordering**

Boolean Algebra

■ Developed by George Boole in 19th Century

- Algebraic representation of logic
 - Encode “True” as 1 and “False” as 0

And

- $A \& B = 1$ when both $A=1$ and $B=1$

$\&$	0	1
0	0	0
1	0	1

Or

- $A | B = 1$ when either $A=1$ or $B=1$

	0	1
0	0	1
1	1	1

Not

- $\sim A = 1$ when $A=0$

\sim	
0	1
1	0

Exclusive-Or (Xor)

- $A \wedge B = 1$ when either $A=1$ or $B=1$, but not both

\wedge	0	1
0	0	1
1	1	0

General Boolean Algebras

■ Operate on Bit Vectors

- Operations applied bitwise

01101001	01101001	01101001	01101001
& 01010101	01010101	^ 01010101	~ 01010101
01000001	01111101	00111100	10101010

■ All of the Properties of Boolean Algebra Apply

Example: Representing & Manipulating Sets

■ Representation

- Width w bit vector represents subsets of $\{0, \dots, w-1\}$
- $a_j = 1$ if $j \in A$

- 01101001 { 0, 3, 5, 6 }

- 76543210

- 01010101 { 0, 2, 4, 6 }

- 76543210

■ Operations

- & Intersection 01000001 { 0, 6 }
- | Union 01111101 { 0, 2, 3, 4, 5, 6 }
- ^ Symmetric difference 00111100 { 2, 3, 4, 5 }
- ~ Complement 10101010 { 1, 3, 5, 7 }

Bit-Level Operations in C

■ Operations $\&$, $|$, \sim , \wedge Available in C

- Apply to any “integral” data type
 - long, int, short, char, unsigned
- View arguments as bit vectors
- Arguments applied bit-wise

■ Examples (Char data type)

- $\sim 0x41 \rightarrow$
 -
- $\sim 0x00 \rightarrow$
 -
- $0x69 \& 0x55 \rightarrow$
 -
- $0x69 | 0x55 \rightarrow$
 -

Hex	Decimal	Binary
0	0	0000
1	1	0001
2	2	0010
3	3	0011
4	4	0100
5	5	0101
6	6	0110
7	7	0111
8	8	1000
9	9	1001
A	10	1010
B	11	1011
C	12	1100
D	13	1101
E	14	1110
F	15	1111

Bit-Level Operations in C

■ Operations $\&$, $|$, \sim , \wedge Available in C

- Apply to any “integral” data type
 - long, int, short, char, unsigned
- View arguments as bit vectors
- Arguments applied bit-wise

■ Examples (Char data type)

- $\sim 0x41 \rightarrow 1011\ 1110$
- $\sim 0x00 \rightarrow 1111\ 1111$
- $0x69 \ \& \ 0x55:$ $0x69 \ | \ 0x55:$

0110 1001	0110 1001
$\& \ 0101\ 0101$	$ \ 0101\ 0101$
-----	-----
0100 0001	0111 1101

Hex	Decimal	Binary
0	0	0000
1	1	0001
2	2	0010
3	3	0011
4	4	0100
5	5	0101
6	6	0110
7	7	0111
8	8	1000
9	9	1001
A	10	1010
B	11	1011
C	12	1100
D	13	1101
E	14	1110
F	15	1111

Contrast: Logic Operations in C

■ Contrast to Bit-Level Operators

- Logic Operations: `&&`, `||`, `!`
 - View 0 as “False”
 - Anything nonzero as “True”
 - Always return 0 or 1
 - Early termination

■ Examples (char data type)

- `!0x41 → 0x00`
- `!0x00 → 0x01`
- `!!0x41 → 0x01`

- `0x69 && 0x55 → 0x01`
- `0x69 || 0x55 → 0x01`
- `p && *p` (avoids null pointer access)

Watch out for `&&` vs. `&` (and `||` vs. `|`)...
Super common C programming pitfall!

Shift Operations

- **Left Shift:** $x \ll y$
 - Shift bit-vector x left y positions
 - Throw away extra bits on left
 - Fill with 0's on right
- **Right Shift:** $x \gg y$
 - Shift bit-vector x right y positions
 - Throw away extra bits on right
 - Logical shift
 - Fill with 0's on left
 - Arithmetic shift
 - Replicate most significant bit on left
- **Undefined Behavior**
 - Shift amount < 0 or \geq word size

Argument x	01100010
$\ll 3$	00010000
Log. $\gg 2$	00011000
Arith. $\gg 2$	00011000

Argument x	10100010
$\ll 3$	00010000
Log. $\gg 2$	00101000
Arith. $\gg 2$	11101000

Today: Bits, Bytes, and Integers

- Representing information as bits
- Bit-level manipulations
- **Integers**
 - Representation: unsigned and signed
 - Conversion, casting
 - Expanding, truncating
 - Addition, negation, multiplication, shifting

Binary Number Lines

- In binary, the number of bits in the data type size determines the number of points on the number line.
 - We can assign the points any meaning we'd like
- Consider the following examples:

- 1 bit number line



- 2 bit number line

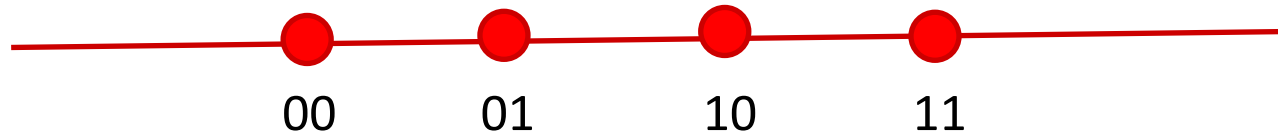

- 3 bit number line

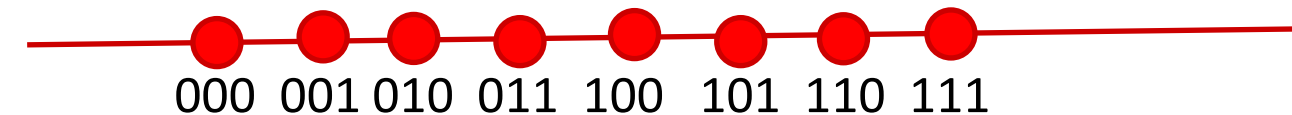

Some Purely Imaginary Examples

■ 3 bit number line

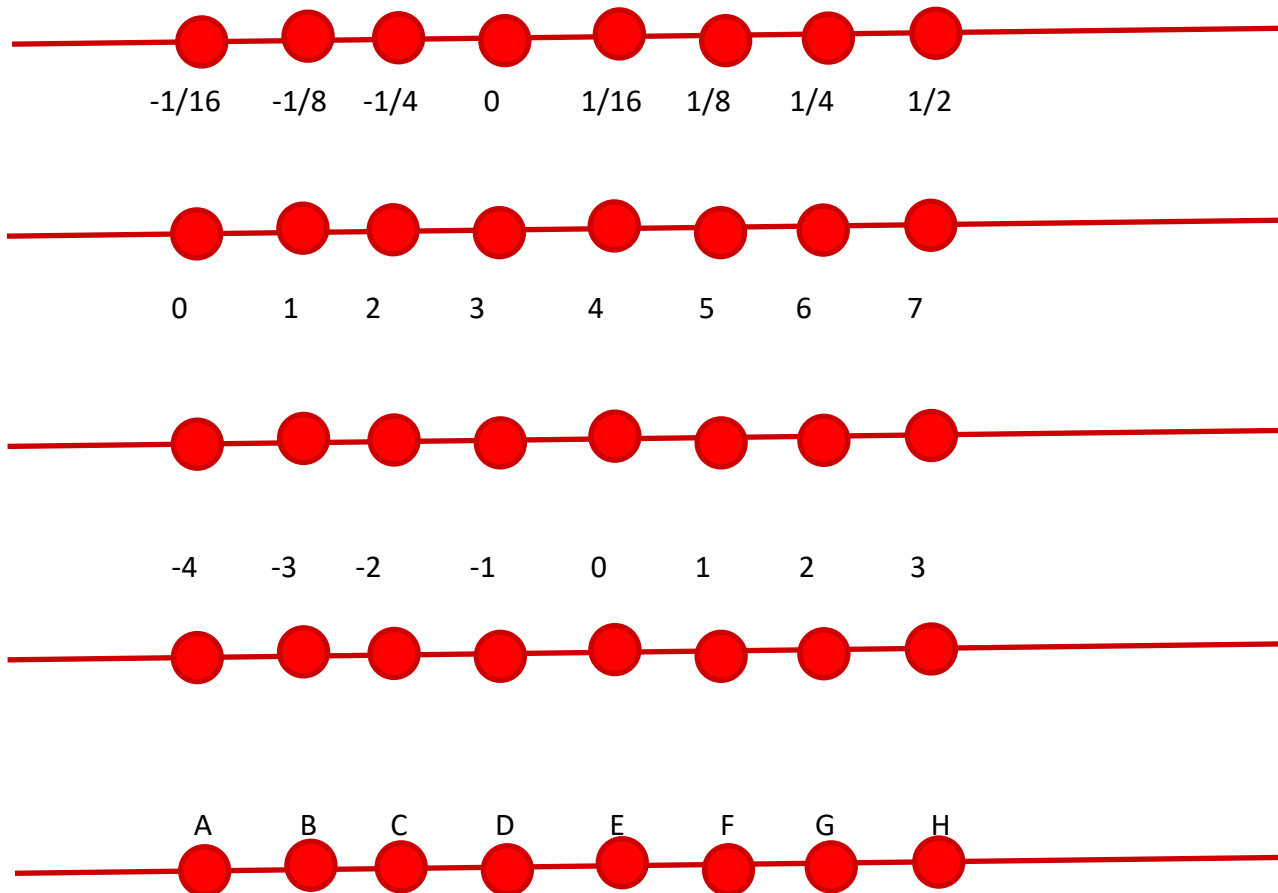

Overflow

- Let's consider a simple 3 digit number line:

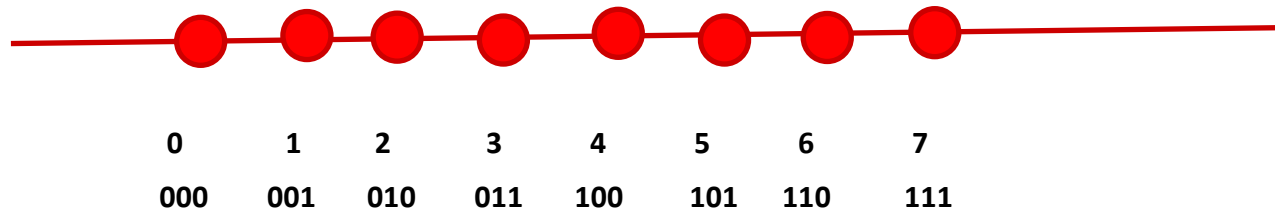

- What happens if we add 1 to 7?
 - In other words, what happens if we add 1 to 111?
- $111 + 001 = 1\ 000$
 - But, we only get 3 bits – so we lose the leading-1.
 - This is called overflow
- The result is 000

Modulus Arithmetic

■ Let's explore this idea of overflow some more

- $111 + 001 = 1\ 000 = 000$
- $111 + 010 = 1\ 001 = 001$
- $111 + 011 = 1\ 010 = 010$
- $111 + 100 = 1\ 011 = 011$
- ...
- $111 + 110 = 1\ 101 = 101$
- $111 + 111 = 1\ 110 = 110$

■ So, arithmetic “wraps around” when it gets “too positive”

Unsigned and Non-Negative Integers

- We'll use the term “ints” to mean the finite set of integer numbers that we can represent on a number line enumerated by some fixed number of bits, i.e. *bit width*.
- We normally represent unsigned and non-negative int using simple binary as we have already discussed
 - An “unsigned” int is any int on a number line, e.g. of a data type, that doesn't contain any negative numbers
 - A non-negative number is a number greater than or equal to (\geq) 0 on a number line, e.g. of a data type, that does contain negative numbers

How represent negative Numbers?

■ We could use the leading bit as a *sign bit*:

- 0 means non-negative
- 1 means negative

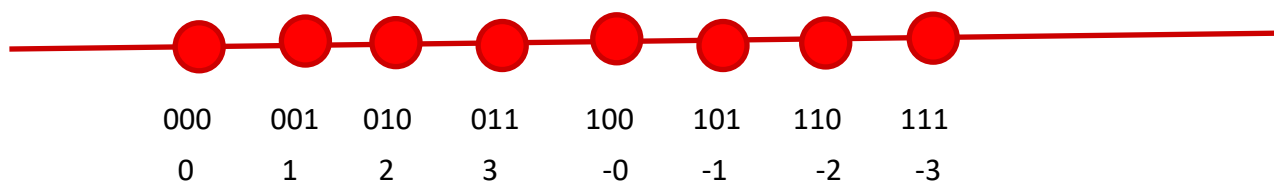

■ This has some benefits

- It lets us represent negative and non-negative numbers
- 0 represents 0

■ It also has some drawbacks

- There is a -0, which is the same as 0, except that it is different
- How to add such numbers $1 + -1$ should equal 0
 - But, by simple math, $001 + 101 = 110$, which is -2?

A Magic Trick!

■ Let's just start with three ideas:

- 1 should be represented as 1
- $-1 + 1 = 0$
- We want addition to work in the familiar way, with simple rules.

■ We want a situation where $\text{"-1"} + 1 = 0$

■ Consider a 3 bit number:

- $001 + \text{"-1"} = 0$
- $001 + 111 = 0$
 - Remember $001 + 111 = 1\ 000$, and the leading one is lost to overflow.

■ $\text{"-1"} = 111$

- Yep!

Negative Numbers

■ Well, if 111 is -1, what is -2?

- -1 - 1
- $111 - 001 = 110$

■ Does that really work?

- If it does $-2 + 2 = 0$
- $110 + 010 = 1\ 000 = 000$

■ $-2 + 5$ should be 3, right?

- $110 + 101 = 1\ 011 = 011$

Finding $-x$ the easy way

- **Given a non-negative number in binary, e.g. 5, represented with a fixed bit width, e.g. 4**
 - 0101
- **We can find its negative by flipping each bit and adding 1**
 - 0101 This is 5
 - 1010 This is the “ones complement of 5”, e.g. 5 with bits flipped
 - 1011 This is the “twos complement of 5”, e.g. 5 with the bits flipped and 1 added
 - $0101 + 1011 = 1\ 0000 = 0000$
 - $-x = \sim x + 1$
- **Because of the fixed width, the “two’s complement” of a number can be used as its negative.**

Why Does This Work?

- Consider any number and its (ones) complement:
 - 0101
 - 1010
- They are called complements because complementary bits are set. As a result, if they are added, all bits are necessarily set:
 - $0101 + 1010 = 1111$
- Adding 1 to the sum of a number and its complement necessarily results in a 0 due to overflow
 - $(0101 + 1010) + 1 = 1111 + 1 = 1\ 0000 = 0000$
- And if $x + y = 0$, y must equal $-x$

Why Does This Work? *Cont.*

- **If $x + y = 0$**
 - y must equal $-x$

- **So if $x + (\text{Complement}(x) + 1) = 0$**
 - $\text{Complement}(x) + 1$ must equal $-x$

- **Another way of looking at it:**
 - if $x + (\text{Complement}(x) + 1) = 0$
 - $x + \text{Complement}(x) = -1$
 - $x = -1 - \text{Complement}(x)$
 - $-x = 1 + \text{Complement}(x)$

Visualizing Two's Complement

- Numbers “wrap around” with -1 at the very end

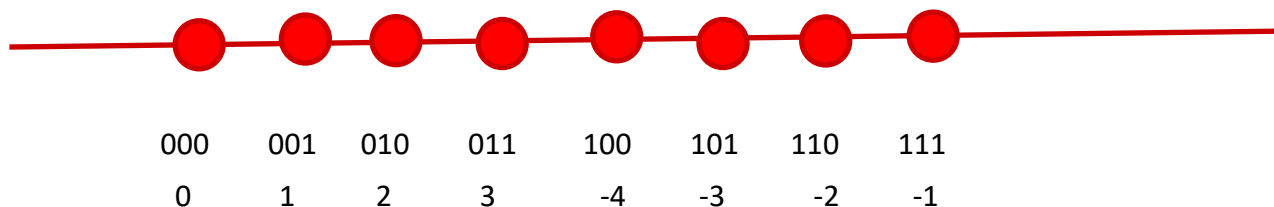

- **A few things to note:**

- All negative numbers start with a “1”
 - E.g. 100 is “-4”
- You can view the leading “1” as introducing a “-4”
 - E.g. $101 = 1 \cdot -4 + 0 \cdot 2 + 1 \cdot 1 = -3$
 - But $010 = 0 \cdot -4 + 1 \cdot 2 + 0 \cdot 1 = 2$
- -4 is missing a positive partner

Complement & Increment Examples

$x = 0$

	Decimal	Hex	Binary
0	0	00 00	00000000 00000000
~ 0	-1	FF FF	11111111 11111111
$\sim 0 + 1$	0	00 00	00000000 00000000

$x = T_{min}$ (The most negative two's complement number)

	Decimal	Hex	Binary
x	-32768	80 00	10000000 00000000
$\sim x$	32767	7F FF	01111111 11111111
$\sim x + 1$	-32768	80 00	10000000 00000000

Canonical counter example

Encoding Integers: Dense Form

Unsigned

$$B2U(X) = \sum_{i=0}^{w-1} x_i \cdot 2^i$$

Two's Complement

$$B2T(X) = -x_{w-1} \cdot 2^{w-1} + \sum_{i=0}^{w-2} x_i \cdot 2^i$$

```
short int x = 15213;
short int y = -15213;
```

Sign
Bit



- **C does not mandate using two's complement**
 - But, most machines do, and we will assume so
- **C short 2 bytes long**

	Decimal	Hex	Binary
x	15213	3B 6D	00111011 01101101
y	-15213	C4 93	11000100 10010011

■ Sign Bit

- For 2's complement, most significant bit indicates sign
 - 0 for nonnegative
 - 1 for negative

Numeric Ranges

■ Unsigned Values

- $UMin = 0$
000...0
- $UMax = 2^w - 1$
111...1

■ Two's Complement Values

- $TMin = -2^{w-1}$
100...0
- $TMax = 2^{w-1} - 1$
011...1
- Minus 1
111...1

Values for $W = 16$

	Decimal	Hex	Binary
UMax	65535	FF FF	11111111 11111111
TMax	32767	7F FF	01111111 11111111
TMin	-32768	80 00	10000000 00000000
-1	-1	FF FF	11111111 11111111
0	0	00 00	00000000 00000000

Today: Bits, Bytes, and Integers

- Representing information as bits
- Bit-level manipulations
- **Integers**
 - Representation: unsigned and signed
 - **Conversion, casting**
 - Expanding, truncating
 - Addition, negation, multiplication, shifting
- **Byte Ordering**

Mapping Signed \leftrightarrow Unsigned

Bits	Signed	Unsigned
0000	0	0
0001	1	1
0010	2	2
0011	3	3
0100	4	4
0101	5	5
0110	6	6
0111	7	7
1000	-8	8
1001	-7	9
1010	-6	10
1011	-5	11
1100	-4	12
1101	-3	13
1110	-2	14
1111	-1	15

Relation between Signed & Unsigned

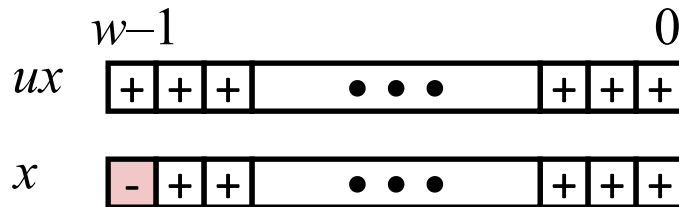
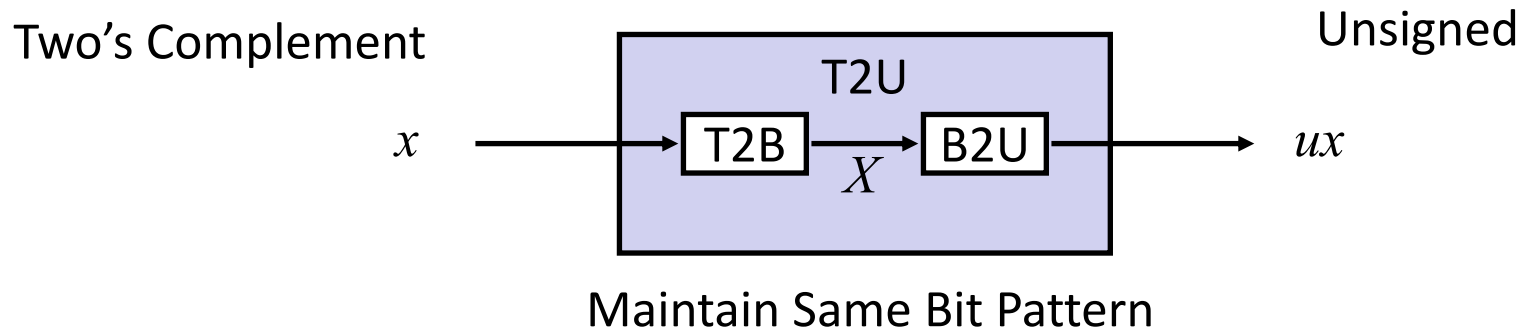

Large negative weight
becomes
 Large positive weight

Conversion Visualized

- 2's Comp. → Unsigned
 - Ordering Inversion
 - Negative → Big Positive

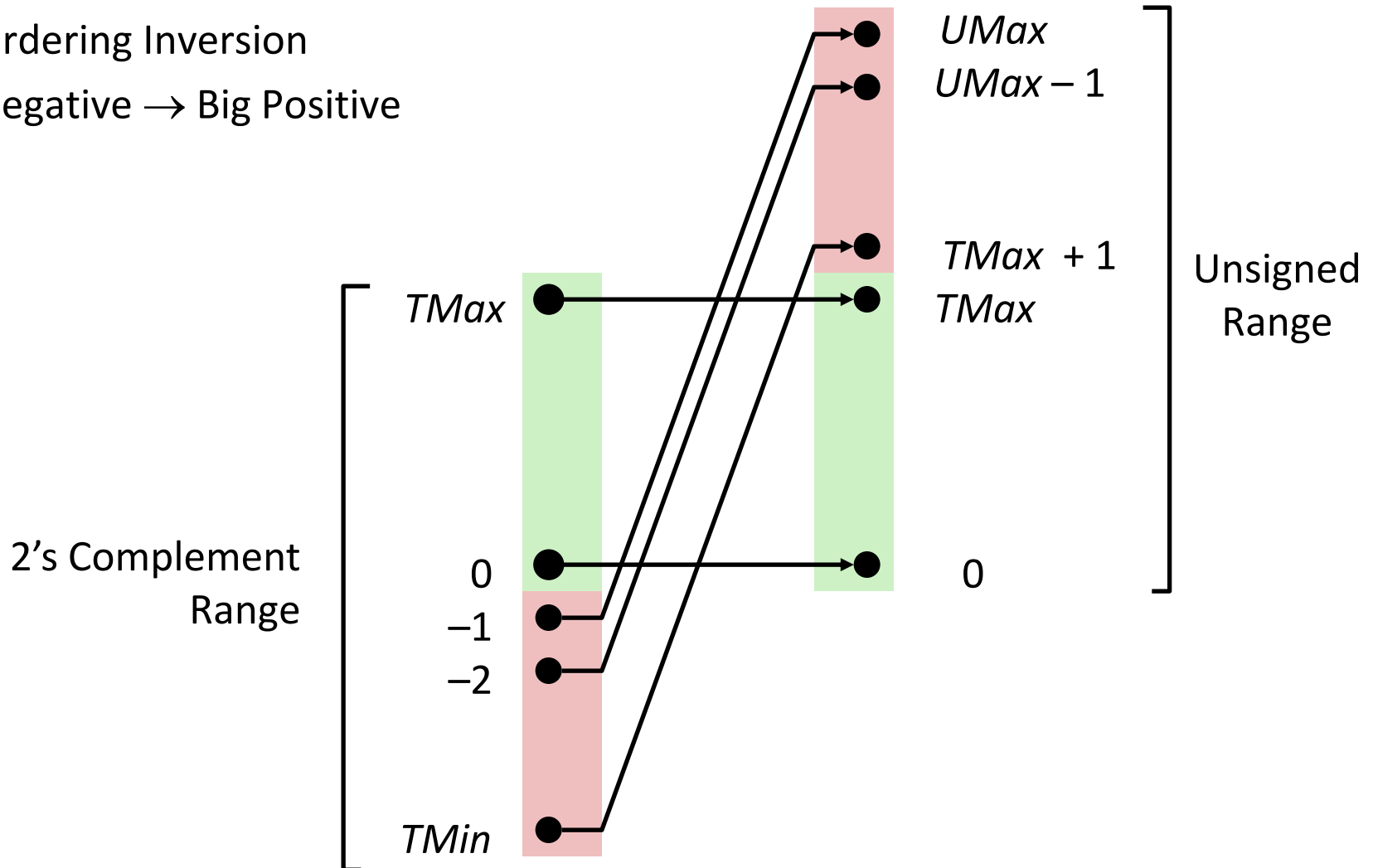

Signed vs. Unsigned in C

■ Constants

- By default are considered to be signed integers
- Unsigned if have “U” as suffix

`0U, 4294967259U`

■ Casting

- Explicit casting between signed & unsigned same as U2T and T2U

```
int tx, ty;
unsigned ux, uy;
tx = (int) ux;
uy = (unsigned) ty;
```

- Implicit casting also occurs via assignments and procedure calls

```
tx = ux;                int fun(unsigned u);
uy = ty;                uy = fun(tx);
```

Casting Surprises

■ Expression Evaluation

- If there is a mix of unsigned and signed in single expression, *signed values implicitly cast to unsigned*
- Including comparison operations $<$, $>$, $==$, $<=$, $>=$
- Examples for $W = 32$: **TMIN = -2,147,483,648**, **TMAX = 2,147,483,647**

■ Constant ₁	Constant ₂	Relation	Evaluation
0	0U	==	unsigned
-1	0	<	signed
-1	0U	>	unsigned
2147483647	-2147483647-1	>	signed
2147483647U	-2147483647-1	<	unsigned
-1	-2	>	signed
(unsigned)-1	-2	>	unsigned
2147483647	2147483648U	<	unsigned
2147483647	(int) 2147483648U	>	signed

Summary

Casting Signed \leftrightarrow Unsigned: Basic Rules

- Bit pattern is maintained
- But reinterpreted
- Can have unexpected effects: adding or subtracting 2^w
- Expression containing signed and unsigned int
 - `int` is cast to unsigned!!

Today: Bits, Bytes, and Integers

- Representing information as bits
- Bit-level manipulations
- **Integers**
 - Representation: unsigned and signed
 - Conversion, casting
 - **Expanding, truncating**
 - Addition, negation, multiplication, shifting
- **Byte Ordering**

Sign Extension

■ Task:

- Given w -bit signed integer x
- Convert it to $w+k$ -bit integer with same value

■ Rule:

- Make k copies of sign bit:
- $X' = \underbrace{x_{w-1}, \dots, x_{w-1}}_{k \text{ copies of MSB}}, x_{w-1}, x_{w-2}, \dots, x_0$

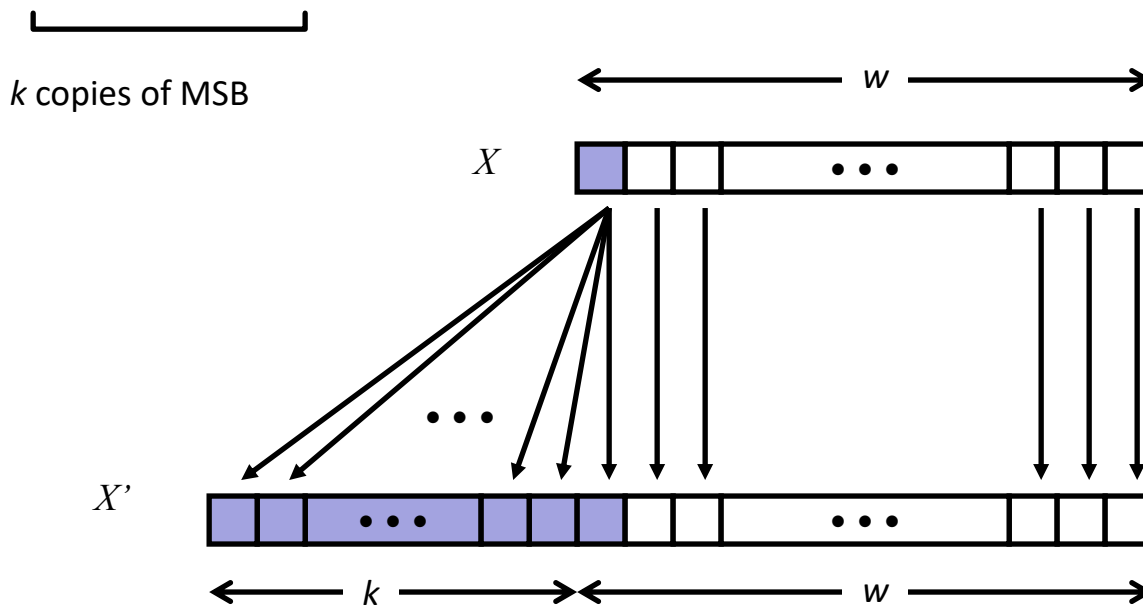

Sign Extension: Simple Example

Positive number

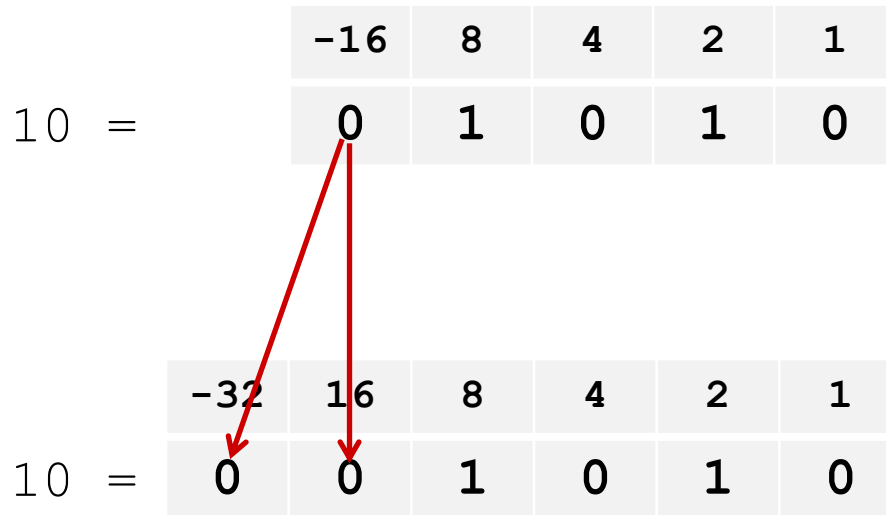

Negative number

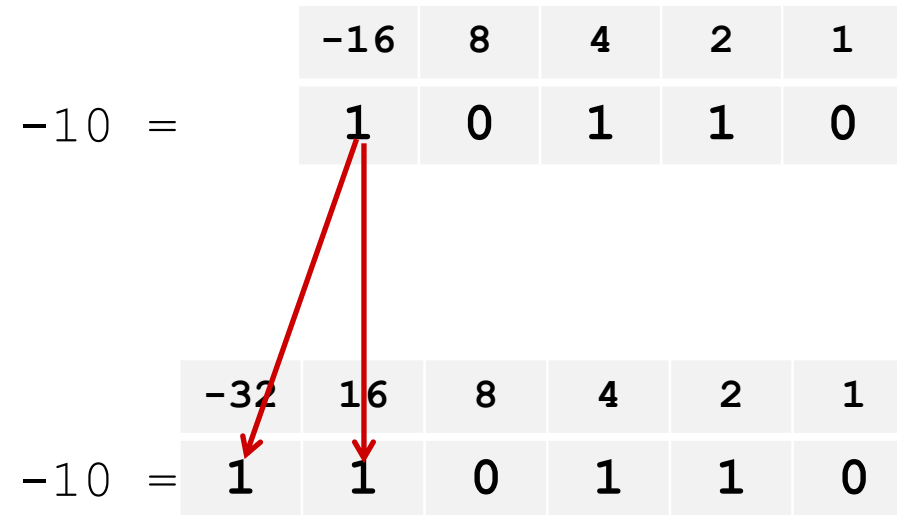

Truncation

■ Task:

- Given $k+w$ -bit signed or unsigned integer X
- Convert it to w -bit integer X' with same value for “small enough” X

■ Rule:

- Drop top k bits:
- $X' = x_{w-1}, x_{w-2}, \dots, x_0$

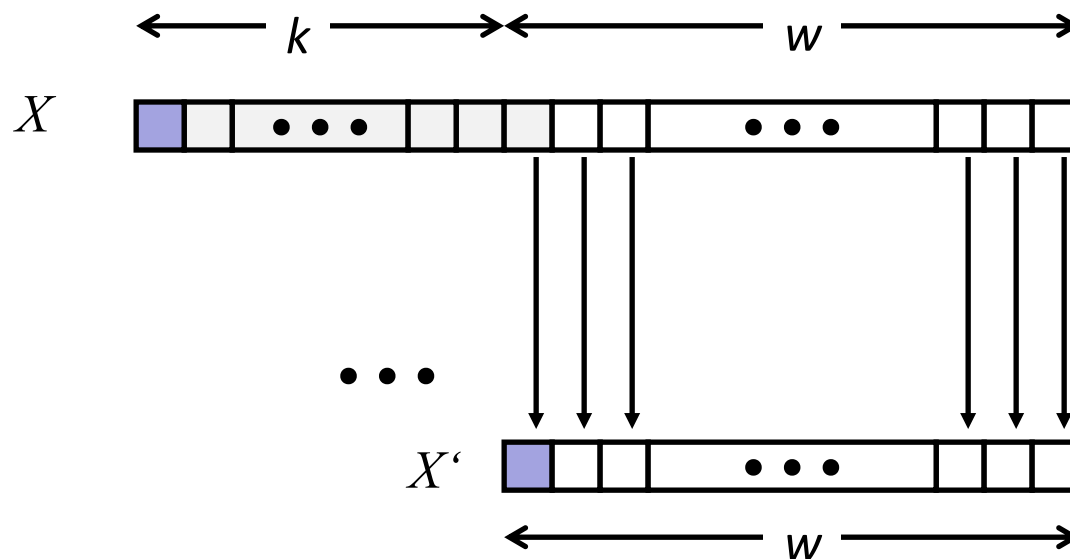

Truncation: Simple Example

No sign change

	-16	8	4	2	1
2 =	0	0	0	1	0

	-8	4	2	1
2 =	0	0	1	0

$$2 \bmod 16 = 2$$

	-16	8	4	2	1
-6 =	1	1	0	1	0

	-8	4	2	1
-6 =	1	0	1	0

$$-6 \bmod 16 = 26U \bmod 16 = 10U = -6$$

Sign change

	-16	8	4	2	1
10 =	0	1	0	1	0

	-8	4	2	1
-6 =	1	0	1	0

$$10 \bmod 16 = 10U \bmod 16 = 10U = -6$$

	-16	8	4	2	1
-10 =	1	0	1	1	0

	-8	4	2	1
6 =	0	1	1	0

$$-10 \bmod 16 = 22U \bmod 16 = 6U = 6$$

Summary:

Expanding, Truncating: Basic Rules

- **Expanding (e.g., short int to int)**
 - Unsigned: zeros added
 - Signed: sign extension
 - Both yield expected result

- **Truncating (e.g., unsigned to unsigned short)**
 - Unsigned/signed: bits are truncated
 - Result reinterpreted
 - Unsigned: mod operation
 - Signed: similar to mod
 - For small (in magnitude) numbers yields expected behavior

Today: Bits, Bytes, and Integers

- Representing information as bits
- Bit-level manipulations
- **Integers**
 - Representation: unsigned and signed
 - Conversion, casting
 - Expanding, truncating
 - **Addition, negation, multiplication, shifting**
- Byte Ordering

Unsigned Addition

Operands: w bits

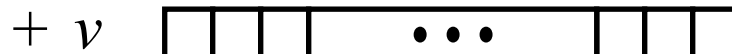

True Sum: $w+1$ bits

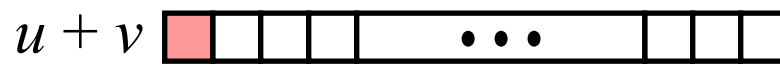

Discard Carry: w bits



■ Standard Addition Function

- Ignores carry output

■ Implements Modular Arithmetic

$$s = \text{UAdd}_w(u, v) = u + v \bmod 2^w$$

unsigned char	1110 1001	E9	223
	+ 1101 0101	+ D5	+ 213
	1 1011 1110	1BE	446
	1011 1110	BE	190

	Hex	Decimal	Binary
0	0	0000	
1	1	0001	
2	2	0010	
3	3	0011	
4	4	0100	
5	5	0101	
6	6	0110	
7	7	0111	
8	8	1000	
9	9	1001	
A	10	1010	
B	11	1011	
C	12	1100	
D	13	1101	
E	14	1110	
F	15	1111	

Two's Complement Addition

Operands: w bits

u 

+ v 

True Sum: $w+1$ bits

$u + v$ 

Discard Carry: w bits

$\text{TAdd}_w(u, v)$ 

■ TAdd and UAdd have Identical Bit-Level Behavior

- Signed vs. unsigned addition in C:

```
int s, t, u, v;
```

```
s = (int) ((unsigned) u + (unsigned) v);
```

```
t = u + v
```

- Will give `s == t`

1110 1001	E9	-23
+ 1101 0101	+ D5	+ -43
1 1011 1110	1BE	-66
1011 1110	BE	-66

Visualizing “True Sum” Integer Addition

■ Integer Addition

- 4-bit integers u, v
- Compute true sum $\text{Add}_4(u, v)$
- Values increase linearly with u and v
- Forms planar surface

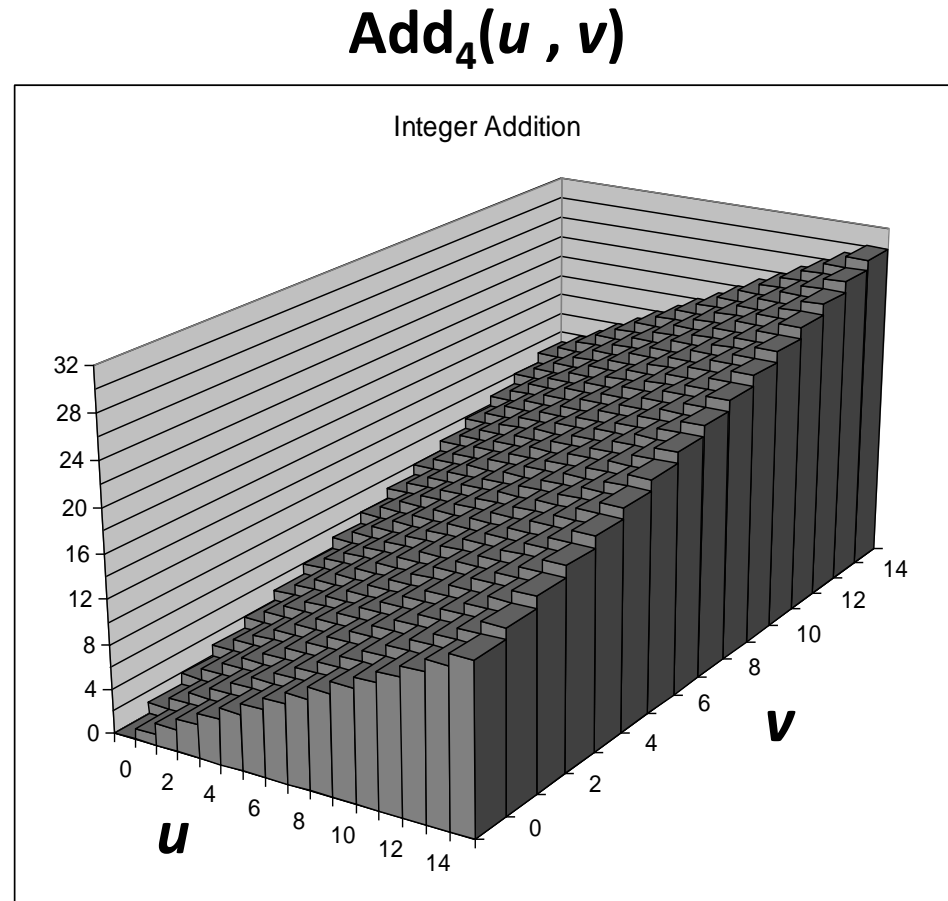

Visualizing Unsigned Addition

■ Wraps Around

- If true sum $\geq 2^w$
- At most once

True Sum

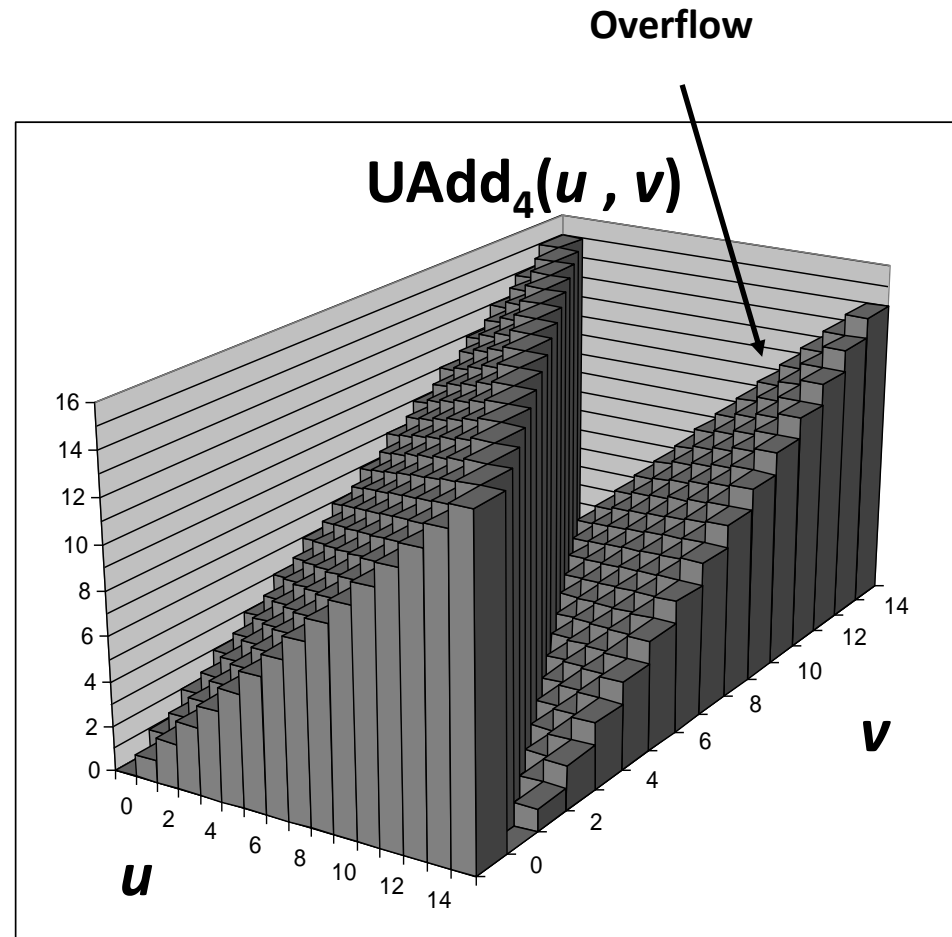
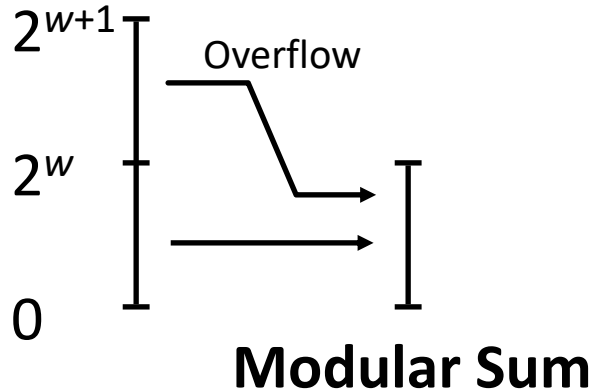

Visualizing 2's Complement Addition

■ Values

- 4-bit two's comp.
- Range from -8 to +7

■ Wraps Around

- If $\text{sum} \geq 2^{w-1}$
 - Becomes negative
 - At most once
- If $\text{sum} < -2^{w-1}$
 - Becomes positive
 - At most once

NegOver

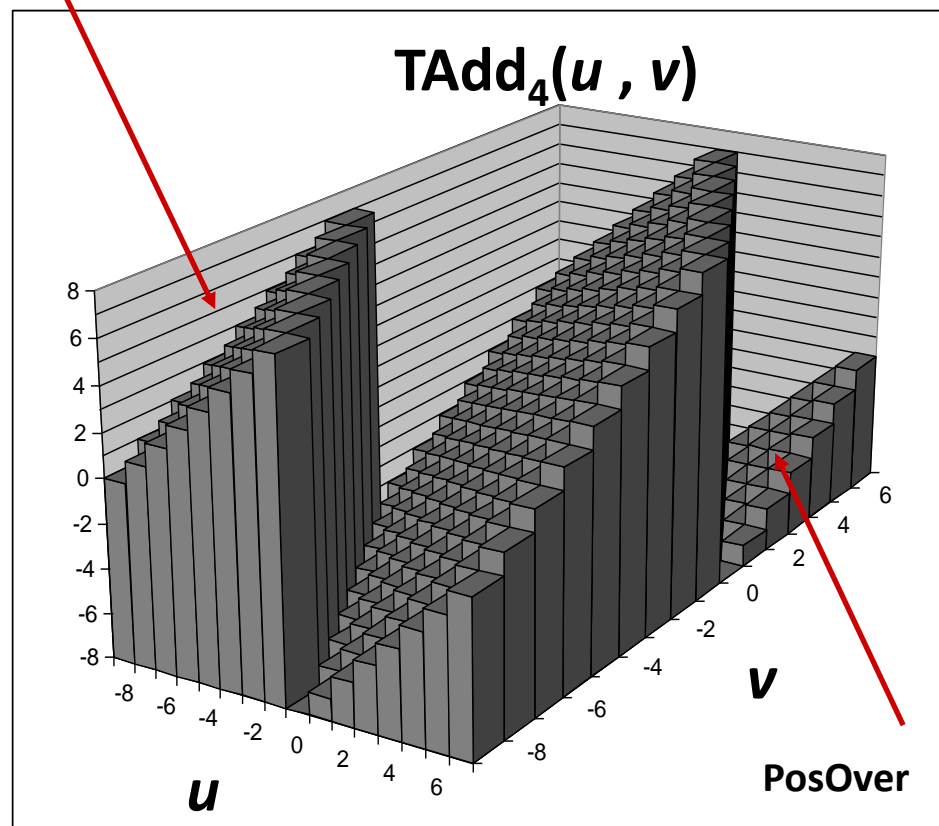

Multiplication

- **Goal: Computing Product of w -bit numbers x, y**
 - Either signed or unsigned
- **Result: Same as computing ideal, exact result $x*y$ and keeping w lower bits.**
- **Ideal, exact results can be bigger than w bits**
 - Worst case is up to $2w$ bits
 - Unsigned, because all bits are magnitude
 - Signed, but only for $T_{min}*T_{min}$, because anything added to T_{min} reduces its magnitude and T_{max} is less than T_{min} .
- **So, maintaining exact results...**
 - would need to keep expanding word size with each product computed
 - Impossible in hardware (at least without limits), as all resources are finite
 - In practice, is done in software, if needed
 - e.g., by “arbitrary precision” arithmetic packages

Power-of-2 Multiply with Shift

■ Operation

- $u \ll k$ gives $u * 2^k$
- Both signed and unsigned

Operands: w bits

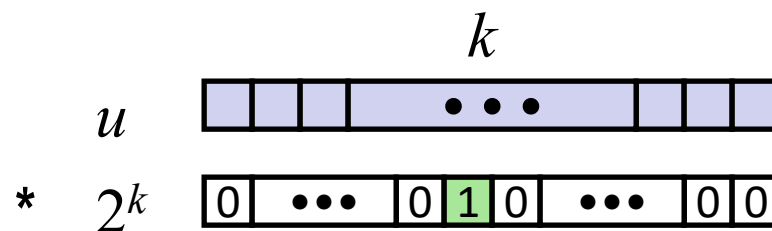

True Product: $w+k$ bits



Discard k bits: w bits

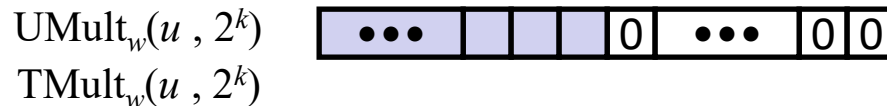

■ Examples

- $u \ll 3 \quad \quad \quad == \quad u * 8$
- $(u \ll 5) - (u \ll 3) \quad == \quad u * 24$
- Most machines shift and add faster than multiply
 - Compiler generates this code automatically

Unsigned Power-of-2 Divide with Shift

■ Quotient of Unsigned by Power of 2

- $u \gg k$ gives $\lfloor u / 2^k \rfloor$
- Uses logical shift

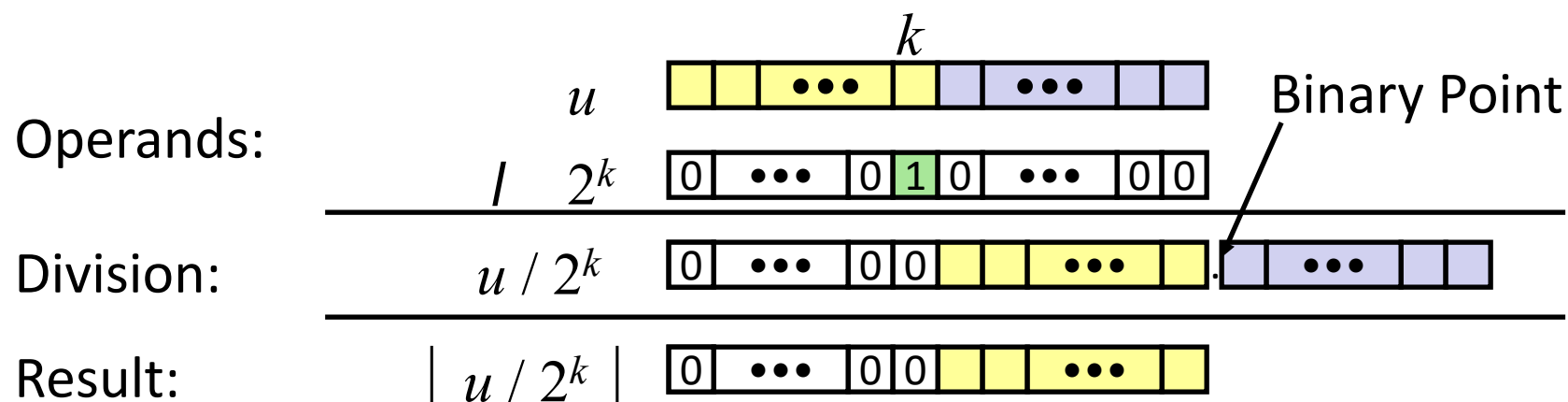

	Division	Computed	Hex	Binary
x	15213	15213	3B 6D	00111011 01101101
x >> 1	7606.5	7606	1D B6	00011101 10110110
x >> 4	950.8125	950	03 B6	00000011 10110110
x >> 8	59.4257813	59	00 3B	00000000 00111011

Signed Power-of-2 Divide with Shift

■ Quotient of Signed by Power of 2

- $x \gg k$ gives $\lfloor x / 2^k \rfloor$
 - Uses arithmetic shift
 - Rounds to the left, not towards zero (Unlikely to be what is expected, introduces a bias).

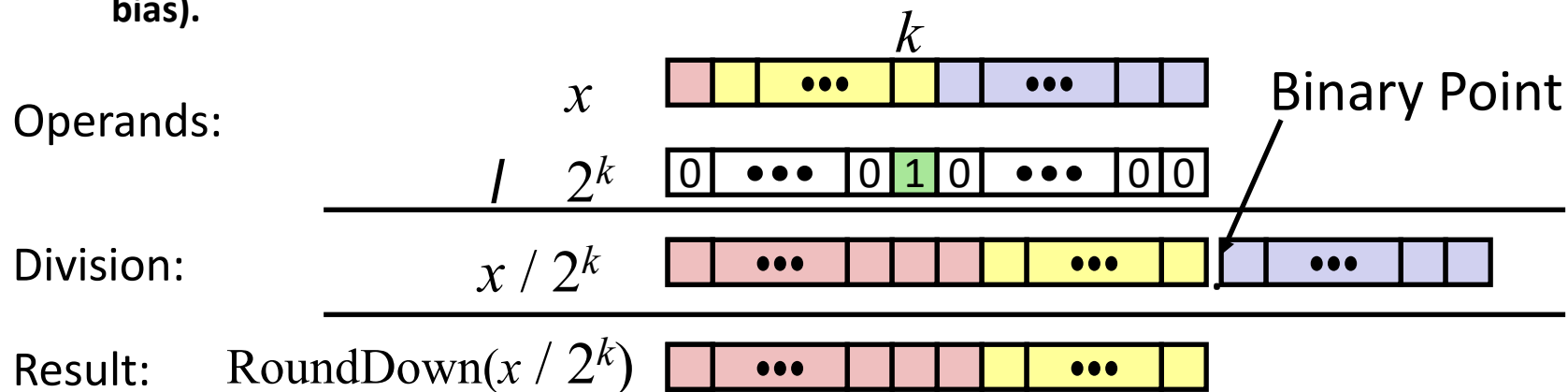

	Division	Computed	Hex	Binary
x	-15213	-15213	C4 93	11000100 10010011
$x \gg 1$	-7606.5	-7607	E2 49	11100010 01001001
$x \gg 4$	-950.8125	-951	FC 49	11111100 01001001
$x \gg 8$	-59.4257813	-60	FF C4	11111111 11000100

Round-toward-0 Divide

■ Quotient of Negative Number by Power of 2

- Want $\lceil x / 2^k \rceil$ (Round Toward 0)
- Compute as $\lfloor (x + (2^k - 1)) / 2^k \rfloor$
 - In C: $(x + (1 \ll k) - 1) \gg k$
 - Biases dividend toward 0

Case 1: No rounding

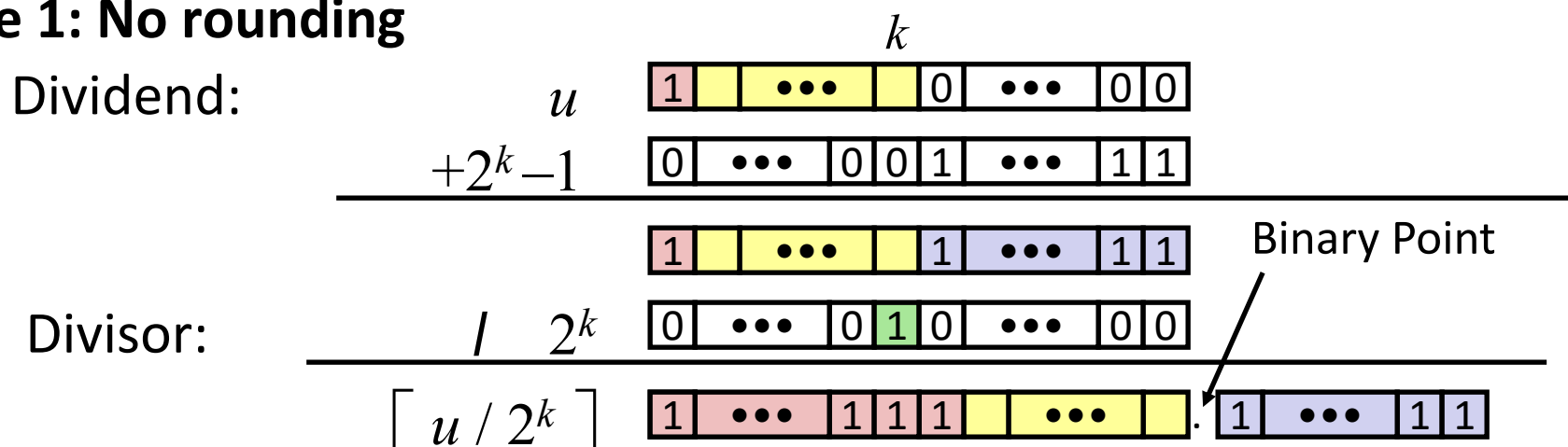

Biassing has no effect

Correct Power-of-2 Divide (Cont.)

Case 2: Rounding

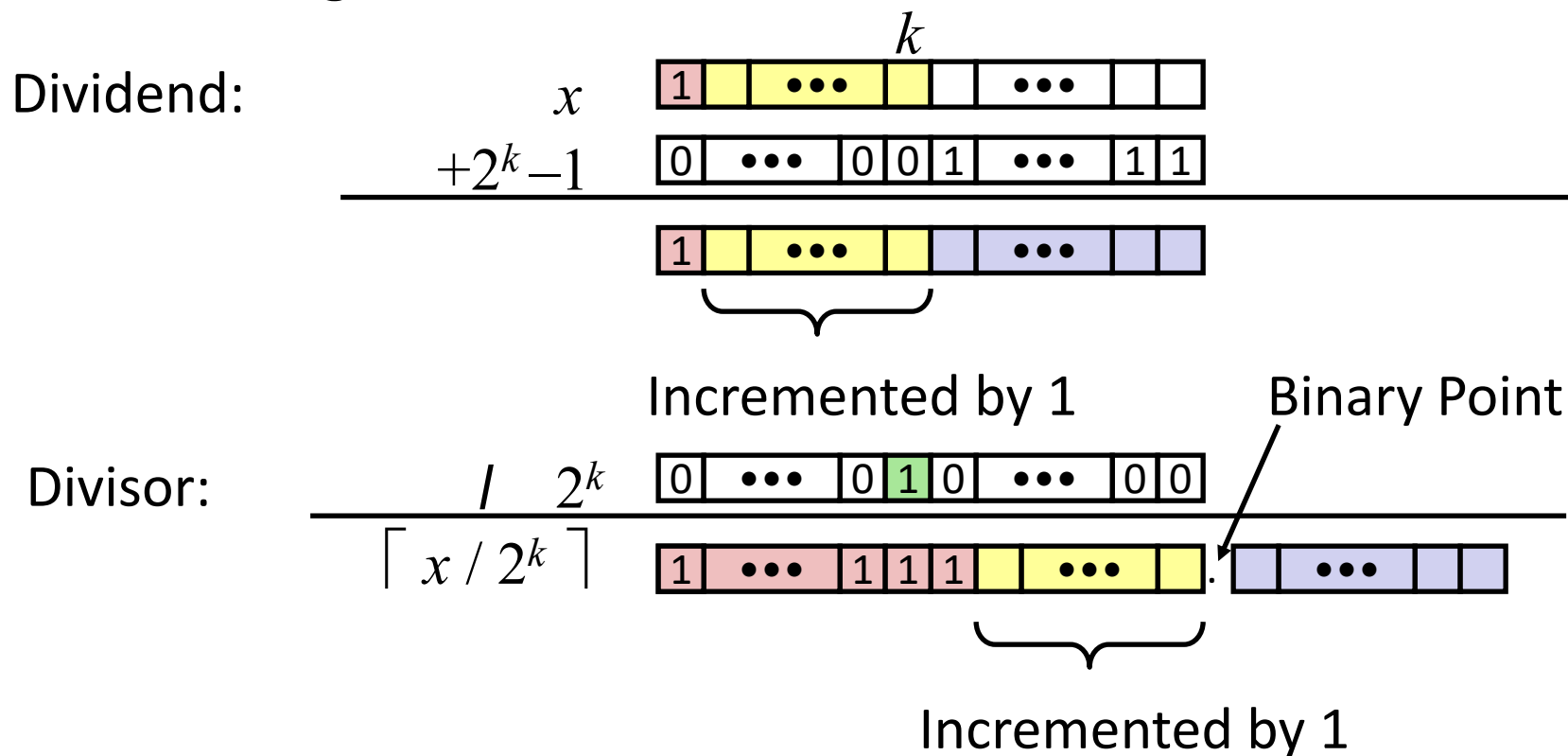

Biasing adds 1 to final result

Today: Bits, Bytes, and Integers

- Representing information as bits
- Bit-level manipulations
- Integers
 - Representation: unsigned and signed
 - Conversion, casting
 - Expanding, truncating
 - Addition, negation, multiplication, shifting
- **Byte Ordering**

Byte Ordering

- **So, how are the bytes within a multi-byte word ordered in memory?**
- **Conventions**
 - Big Endian: Sun (Oracle SPARC), PPC Mac, *Internet*
 - Least significant byte has highest address
 - Little Endian: *x86*, ARM processors running Android, iOS, and Linux
 - Least significant byte has lowest address
- **Becomes a concern when data is communicated**
 - Over a network, via files, etc.
- **Important notes**
 - Bits are not reversed, as the low order bit is the reference point.
 - Doesn't affect chars, or strings (arrays of chars), as chars are only one byte

Byte Ordering Example

■ Example

- Variable x has 4-byte value of 0x01234567
- Address given by &x is 0x100

Big Endian

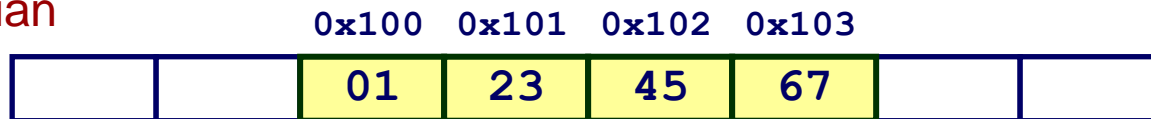

Little Endian

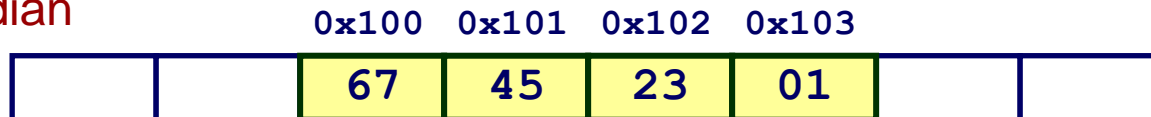

Reading Byte-Reversed Listings

■ Disassembly

- Text representation of binary machine code
- Generated by program that reads the machine code

■ Example Fragment

Address	Instruction Code	Assembly Rendition
8048365:	5b	pop %ebx
8048366:	81 c3 ab 12 00 00	add \$0x12ab,%ebx
804836c:	83 bb 28 00 00 00 00	cmpl \$0x0,0x28(%ebx)

■ Deciphering Numbers

- Value: 0x12ab
- Pad to 32 bits: 0x000012ab
- Split into bytes: 00 00 12 ab
- Reverse: ab 12 00 00

Thanks!

- Questions?