

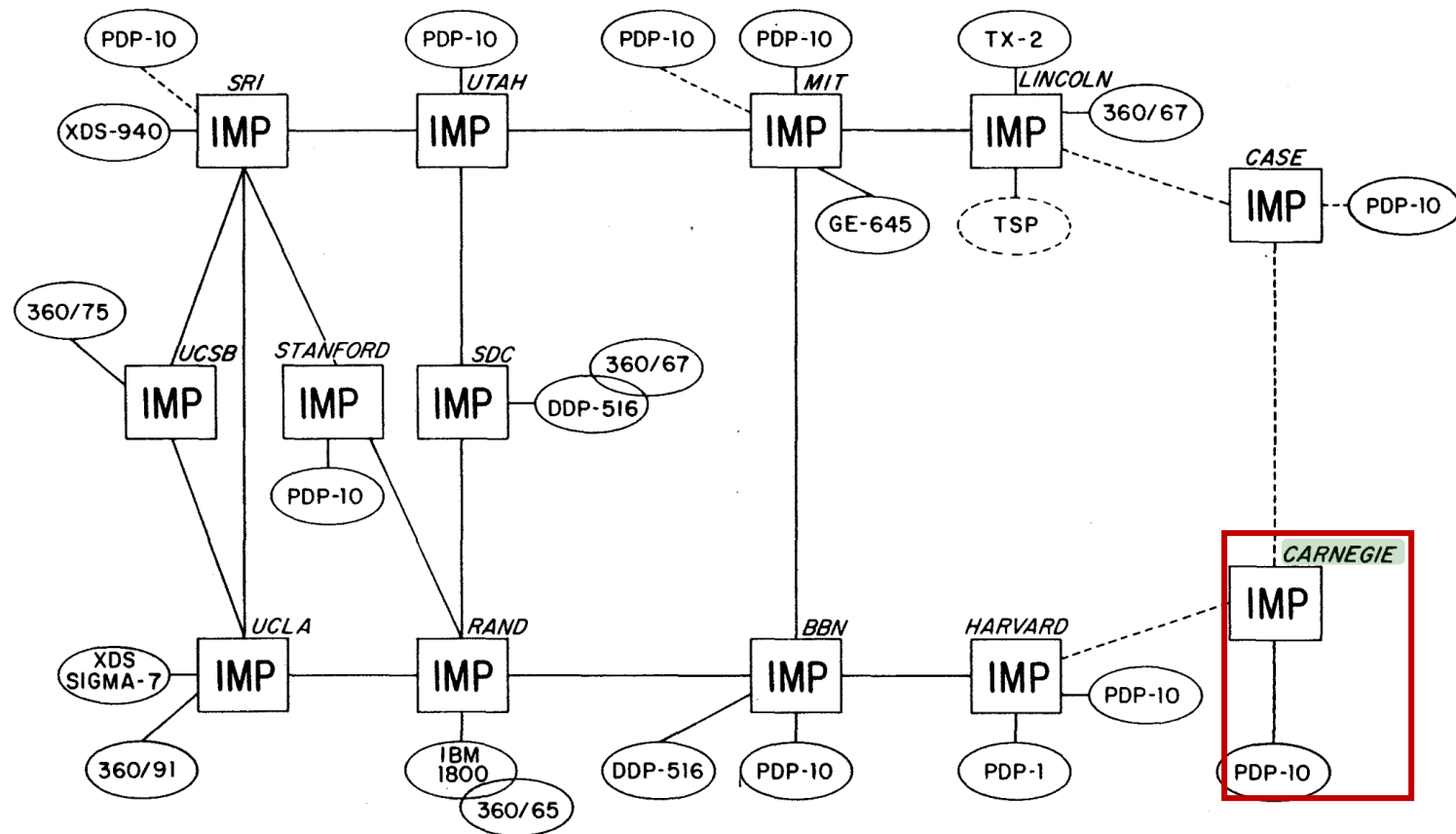

Network Programming: Part I

18-213/18-613: Introduction to Computer Systems
20th Lecture, March 28, 2024



ARPA NET, DECEMBER 1970

Today

- **Network Layers: Bird's Eye View**
- **Global IP Internet**
- **Sockets Interface**

CSAPP 11.3

CSAPP 11.4

How to Design a Network?

- Has many users
- Offers diverse services
- Mixes very diverse technologies
- Components built by many companies
- Diverse ownership
- Can evolve over time

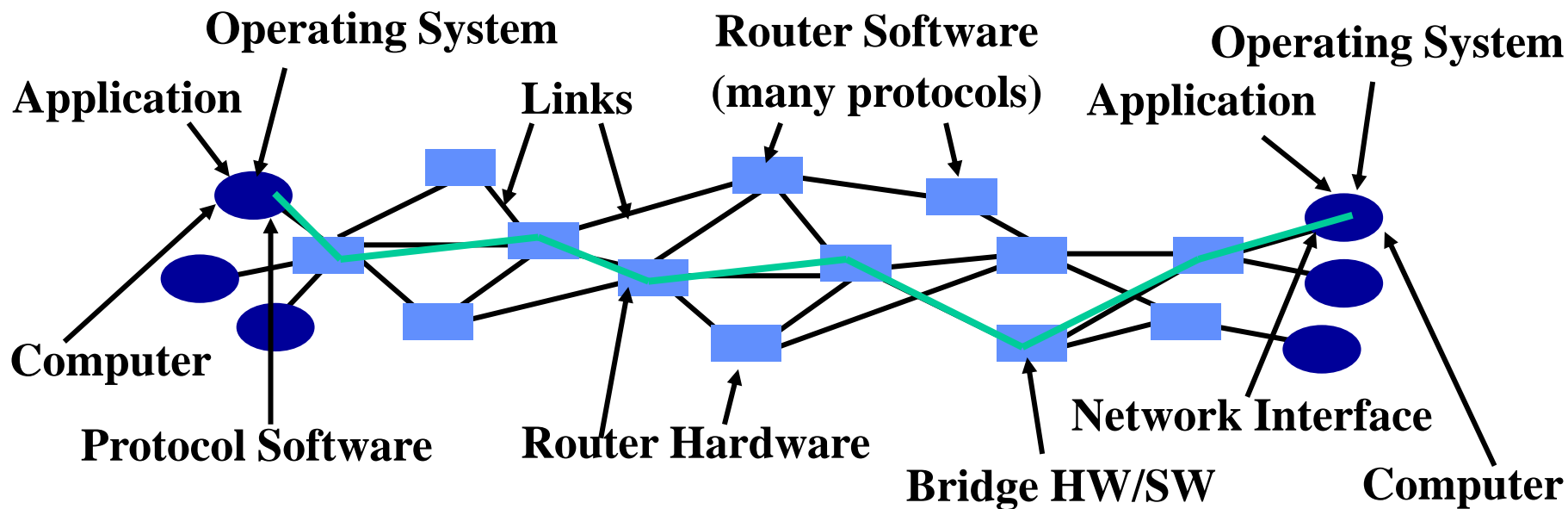

Solution #1?

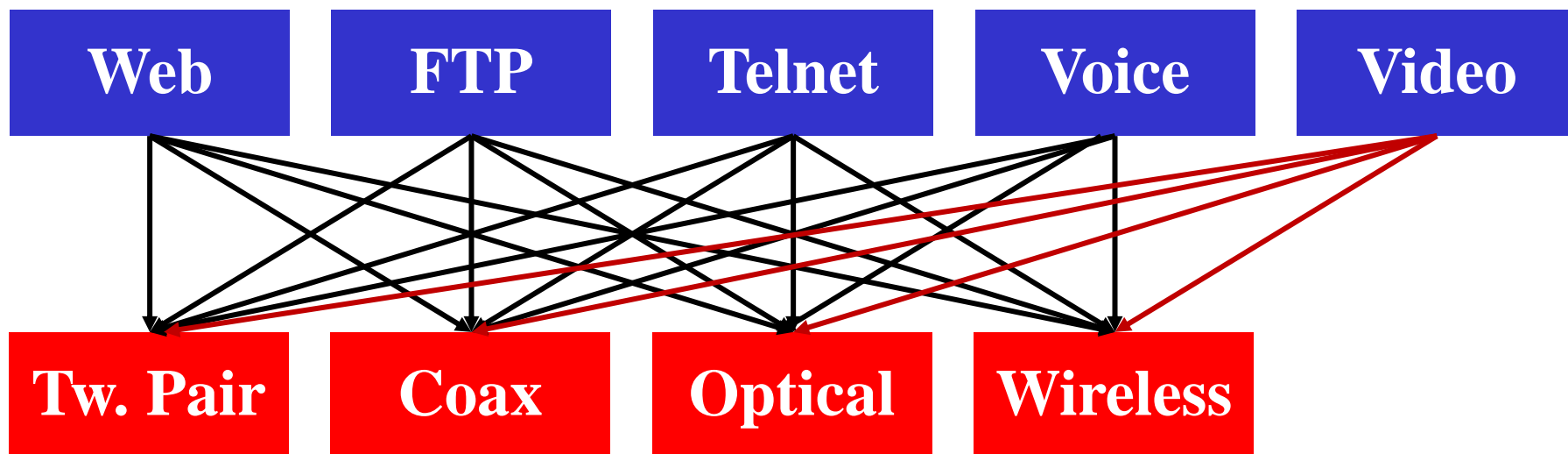

Solution #2

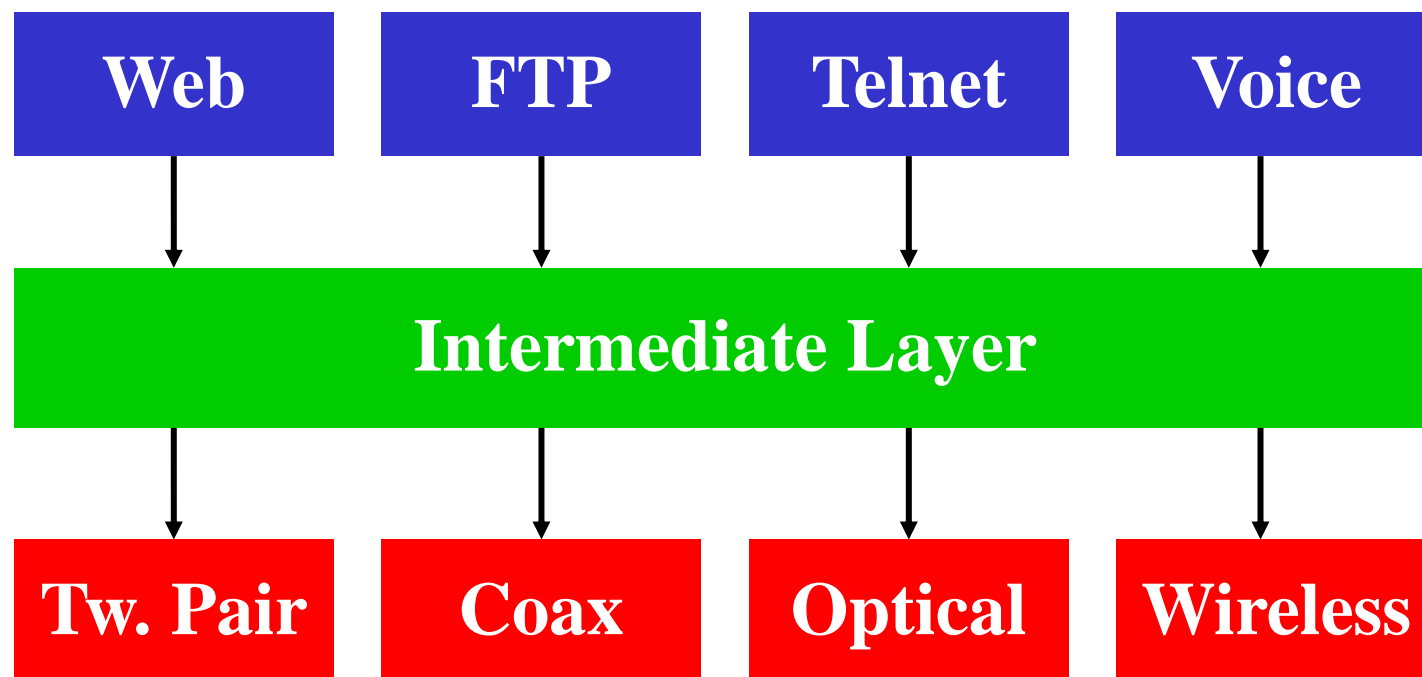

Layering: A Modular Approach to Networking

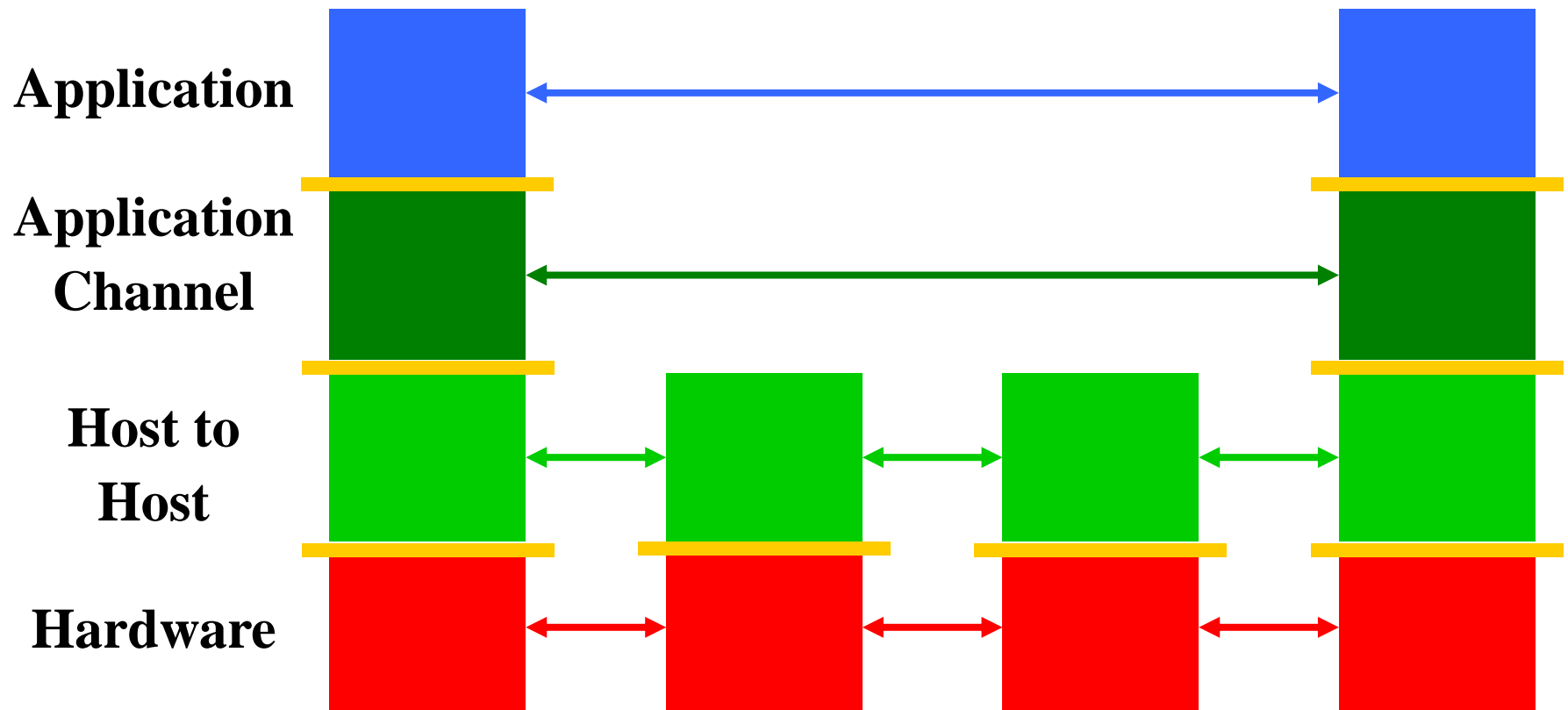

Network Reference Model

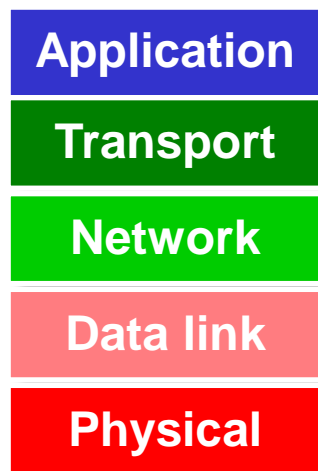

- **Application** – Establish an idiom for communicating with a particular application
- **Transport** – Establish endpoints useful to a programmer
- **Network** – Given multiple inter-connected LANs, achieve cross-connectivity
- **Link** – Manage the channel to enable actual communication, i.e. establish a LAN
- **Physical** – Establish a channel with connectivity and signaling

Physical Layer: Establishes the Channel

- **Medium? Light? Radio frequency? Electrical signals?**
 - What color(s) of light? How bright?
 - What RF frequencies? How powerful?
 - What signals represent what values?
 - What shape are the connectors?
 - How far can cables run?
 - Etc.

- **We have a functioning physical layer once we can send and receive signals.**

Physical

Physical Layer: Bandwidth vs. Latency

- **Bandwidth = bits/second**
 - Improved with parallelism or faster clock rate
- **Latency = Function of signal propagation speed**
 - Limited by speed of light
 - Major paradigm shift would be needed to make traffic to India or China less latent
- **Latency tends to be limiting at a global scale**
 - Speed of light over long distances
- **Bandwidth may be limited at local scale, e.g. data center**
 - How to divide up and recombine messages to utilize parallelism?
 - How to clock faster without losing signal to noise.

Physical

Link Layer: Manages the Channel

- When do we start transmitting? When do we stop?
- When do we start receiving? When do we stop?
- Who is sending? Who is receiving?
- How do we know if it is correct?
- What happens if there is contention for, or collision in, a shared channel?
- Key contributions: Framing, among others
- **We have a functioning link layer once we can build a functioning local area network (LAN) of at least two stations.**

Data link

Physical

Network layer: Scaling up

- **Passing messages among multiple networks**
 - For scale
 - Of different types (wired, wireless, fiber, infrared, etc)
 - Managed by different domains, etc.
- **Globally meaningful addressing: IPv4, IPv6**
- **Ability to choose paths among multiple options**
- **We have a functioning network layer once we can connect multiple networks, identify hosts among them, and messages can find their way across networks from source to destination.**

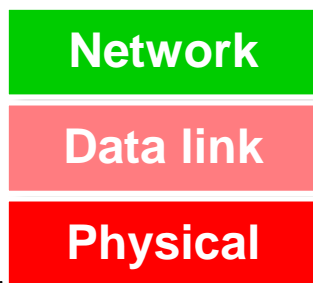

Transport Layer: Meaningful endpoints

- **Hosts don't do communication – various aspects of software systems do**
 - Consider how many different sessions your Web browser has with servers. Now add for your IM sessions, upgrades-in-progress, music streaming, etc.
- **Endpoints enable the establishment of sessions**
 - Classic model is <IPaddress:port>:<IPaddress:port>
 - Client: Ephemeral port. Host: Well-known port
- **Character of communication**
 - Reliable/session-oriented, e.g. TCP
 - Unreliable/datagram, e.g. UDP
 - Etc.
- **The transport layer exists once we have the ability to establish communication from end-point to end-point with well-understood properties.**

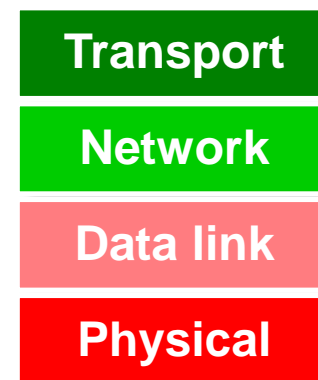

Application Layer: Purposeful Communication

- Defined by the messaging we, as programs, bake into our applications, shaped by our applications
 - e.g., client-server interactions, peer-to-peer interactions, etc.
- E.g., HTTP: PUT, GET, POST, etc.
- E.g., DNS: queries, responses, updates, etc.
- MIME, VOIP protocols, etc.
- Application protocols exist when applications can communicate

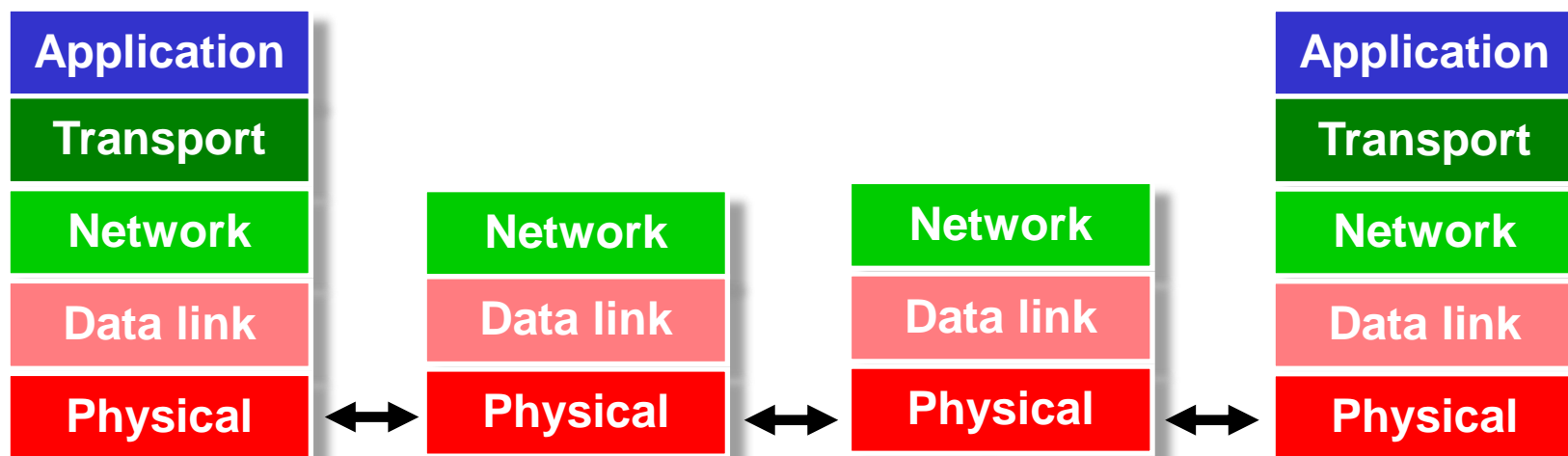

Today

- Network Layers: Bird's Eye View
- **Global IP Internet**
- Sockets Interface

A Map of 460 Billion Device Connections to the Internet collected by the Carna Botnet

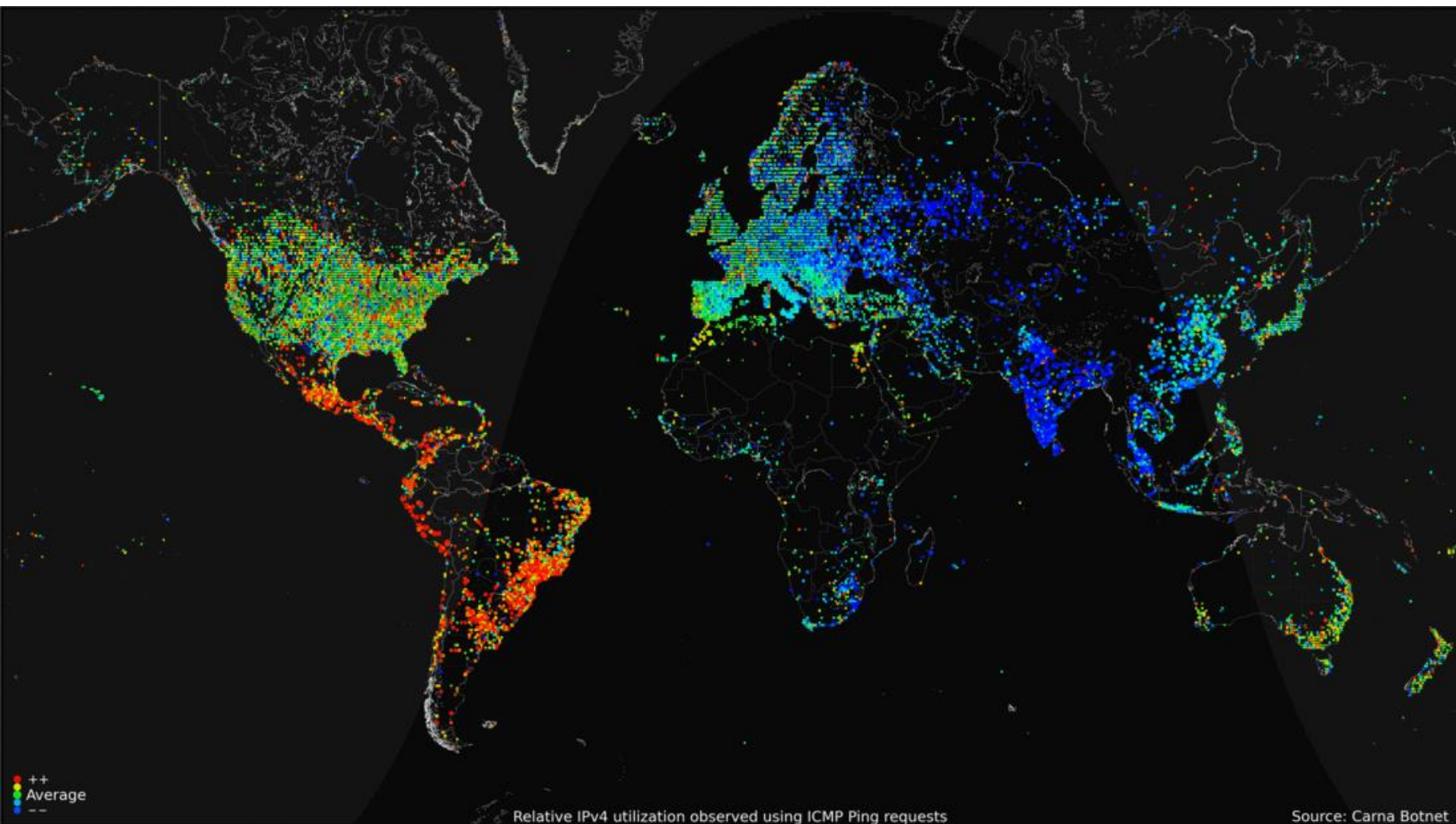

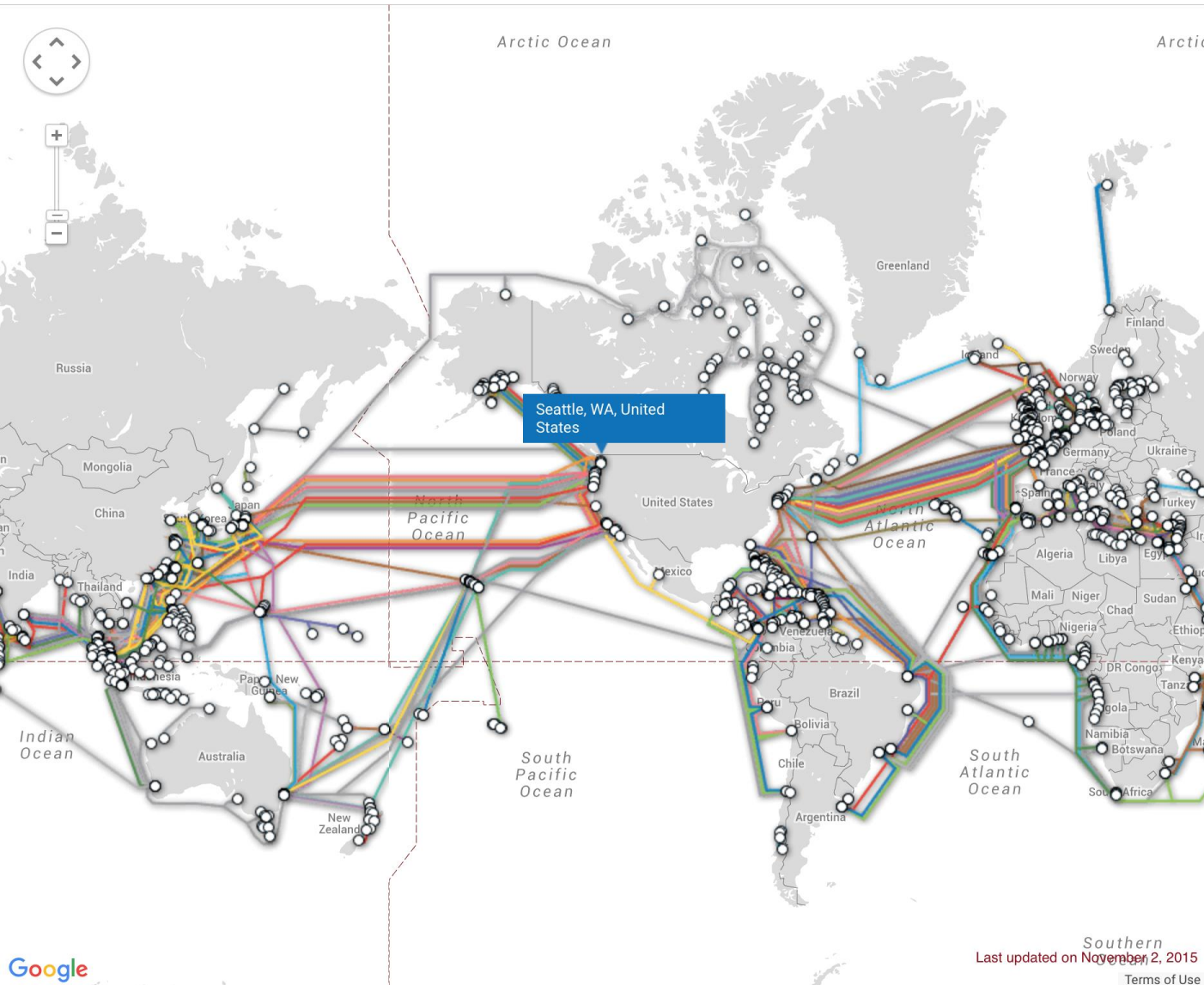

TeleGeography Submarine Cable Map

The [Submarine Cable Map](#) is a free resource from TeleGeography. Data contained in this map is drawn from the [Global Bandwidth Research Service](#) and is updated on a regular basis.

To learn more about TeleGeography or this map please click [here](#).



Sponsored in part by Huawei Marine

Feedback [t](#) [f](#) [github](#)

[Submarine Cable List](#)

Seattle, WA, United States

[Email link](#)

Cables

[Arctic Fibre](#)

Google
Last updated on October 2, 2015
[Terms of Use](#)

All content © 2015 PriMetrica, Inc.

Global IP Internet

- **Based on the TCP/IP protocol family**
 - IP (Internet Protocol)
 - Provides *basic naming scheme* and unreliable *delivery capability* of packets (datagrams) from *host-to-host*
 - UDP (Unreliable Datagram Protocol)
 - Uses IP to provide *unreliable* datagram delivery from *process-to-process*
 - TCP (Transmission Control Protocol)
 - Uses IP to provide *reliable* byte streams from *process-to-process* over *connections*
- **Accessed via a mix of Unix file I/O and functions from the *sockets interface***

A Client-Server Transaction

- Most network applications are based on the client-server model:
 - A **server** process and one or more **client** processes
 - Server manages some **resource**
 - Server provides **service** by manipulating resource for clients
 - Server activated by request from client (vending machine analogy)

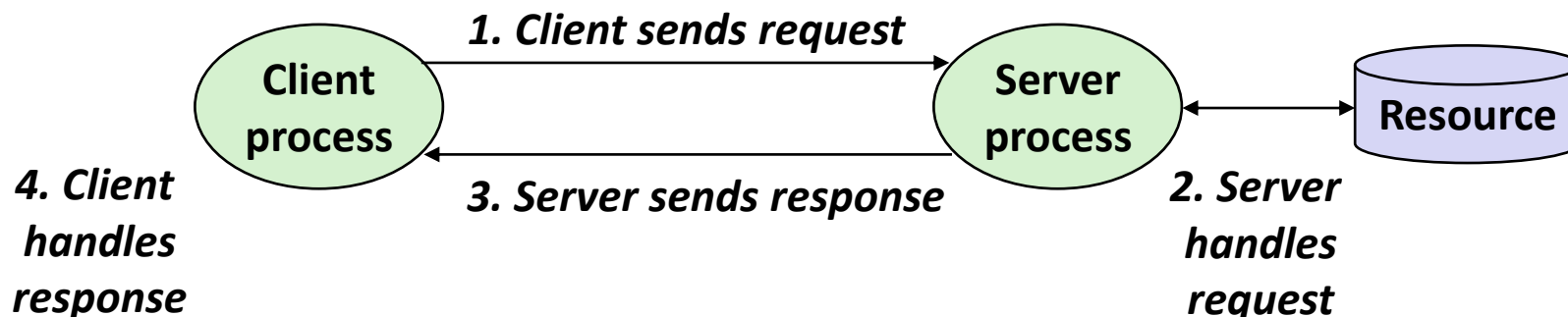

*Note: clients and servers are processes running on hosts
(can be the same or different hosts)*

Hardware and Software Organization of a Client-Server Internet Application

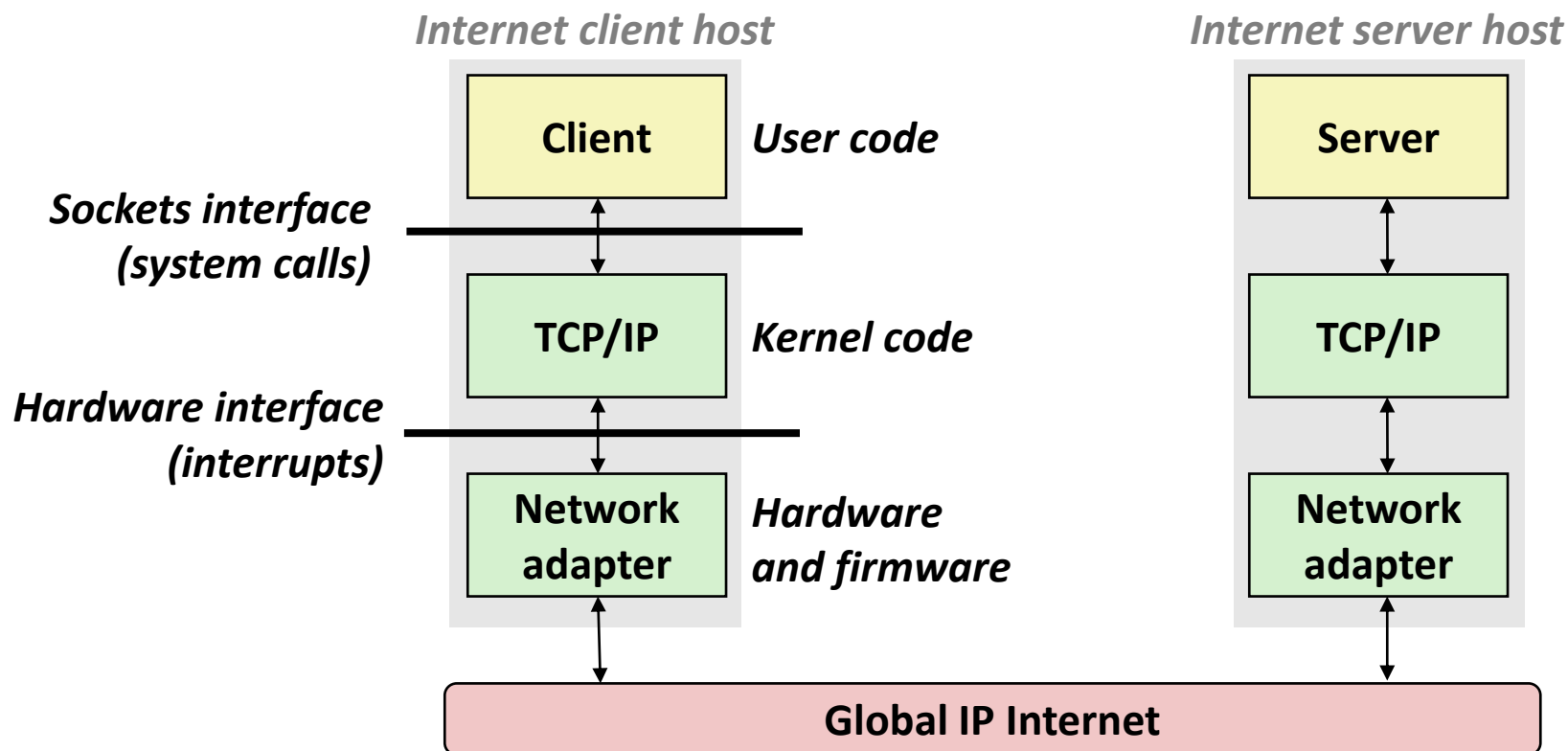

A Programmer's View of the Internet

1. Hosts are mapped to a set of 32-bit *IP addresses*

- 128.2.203.179
- 127.0.0.1 (always *localhost*)

2. The set of IP addresses is mapped to a set of identifiers called Internet *domain names*

- 128.2.217.3 is mapped to `www.cs.cmu.edu`

3. A process on one Internet host can communicate with a process on another Internet host over a *connection*

Aside: IPv4 and IPv6

- The original Internet Protocol, with its 32-bit addresses, is known as *Internet Protocol Version 4 (IPv4)*
- 1996: Internet Engineering Task Force (IETF) introduced *Internet Protocol Version 6 (IPv6)* with 128-bit addresses
 - Intended as the successor to IPv4
- Majority of Internet traffic still carried by IPv4

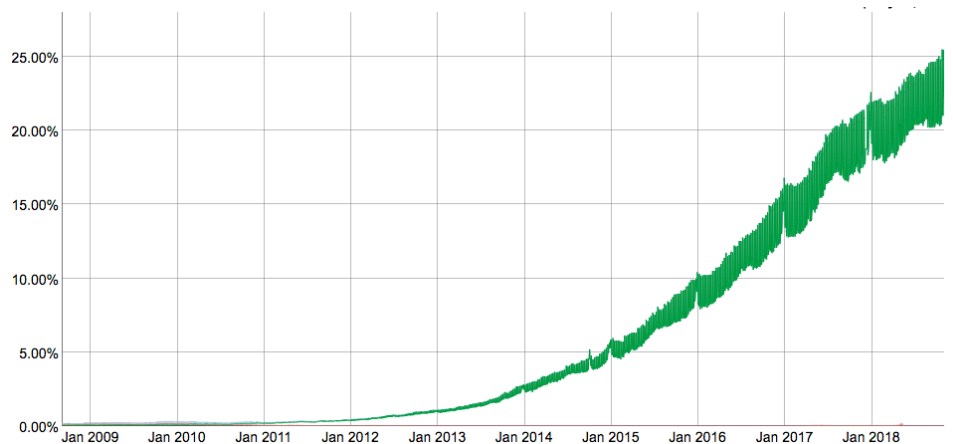

IPv6 traffic at Google

- We will focus on IPv4, but will show you how to write networking code that is protocol-independent.

(1) IP Addresses

- **32-bit IP addresses are stored in an *IP address struct***
 - IP addresses are always stored in memory in *network byte order* (big-endian byte order)
 - True in general for any integer transferred in a packet header from one machine to another.
 - E.g., the port number used to identify an Internet connection.

```
/* Internet address structure */
struct in_addr {
    uint32_t  s_addr; /* network byte order (big-endian) */
};
```

Dotted Decimal Notation

- By convention, each byte in a 32-bit IP address is represented by its decimal value and separated by a period
 - IP address: `0x8002C2F2` = `128.2.194.242`
- Use `getaddrinfo` and `getnameinfo` functions (described later) to convert between IP addresses and dotted decimal format.

(2) Internet Domain Names

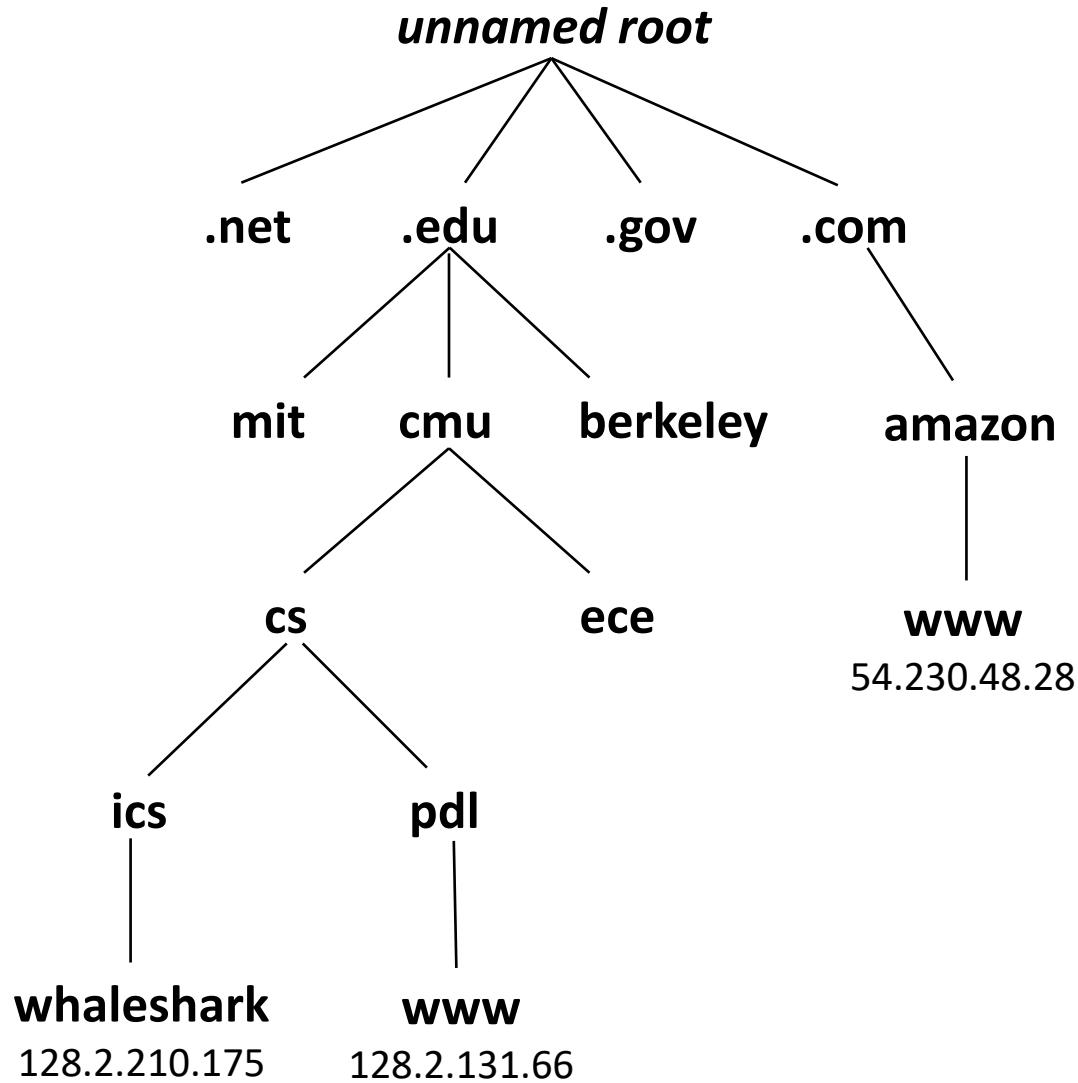

First-level domain names

Second-level domain names

Third-level domain names

.space	.store	.stream	.studio
.study	.style	.supplies	.supply
.support	.surf	.surgery	.sydney
.systems	.taipei	.tattoo	.tax
.taxi	.team	.tech	.technology
.tennis	.theater	.theatre	.tienda
.tips	.tires	.tirol	.today
.tokyo	.tools	.top	.tours
.town	.toys	.trade	.trading
.training	.tube	.university	.uno
.vacations	.vegas	.ventures	.versicherung
.vet	.viajes	.video	.villas
.vin	.vip	.vision	.vlaanderen
.vodka	.vote	.voting	.voto
.voyage	.wales	.wang	.watch
.webcam	.website	.wed	.wedding
.whoswho	.wien	.wiki	.win
.wine	.work	.works	.world
.wtf	.在线	.移动	.онлайн
.сайт	.сайт	.org	.中文网
.संगठन	.机构	.みんな	.游戏
.企业	.xyz	.yoga	.yokohama
.zone			

Domain Naming System (DNS)

- The Internet maintains a mapping between IP addresses and domain names in a huge worldwide distributed database called *DNS*
- Conceptually, programmers can view the DNS database as a collection of millions of *host entries*.
 - Each host entry defines the mapping between a set of domain names and IP addresses.
 - In a mathematical sense, a host entry is an equivalence class of domain names and IP addresses.

Properties of DNS Mappings

- Can explore properties of DNS mappings using `nslookup`
 - (In our examples, the output is edited for brevity)
- Each host has a locally defined domain name `localhost` which always maps to the *loopback address* `127.0.0.1`

```
linux> nslookup localhost  
Address: 127.0.0.1
```

- Use `hostname` to determine real domain name of local host:

```
linux> hostname  
whaleshark.ics.cs.cmu.edu
```

Properties of DNS Mappings (cont)

- **Simple case: one-to-one mapping between domain name and IP address:**

```
linux> nslookup whaleshark.ics.cs.cmu.edu  
Address: 128.2.210.175
```

- **Multiple domain names mapped to the same IP address:**

```
linux> nslookup cs.mit.edu  
Address: 18.62.1.6  
linux> nslookup eecs.mit.edu  
Address: 18.62.1.6
```

Properties of DNS Mappings (cont)

- Multiple domain names mapped to multiple IP addresses:

```
linux> nslookup www.twitter.com
Address: 104.244.42.65
Address: 104.244.42.129
Address: 104.244.42.193
Address: 104.244.42.1
```

```
linux> nslookup twitter.com
Address: 104.244.42.129
Address: 104.244.42.65
Address: 104.244.42.193
Address: 104.244.42.1
```

- Some valid domain names don't map to any IP address:

```
linux> nslookup ics.cs.cmu.edu
(No Address given)
```

(3) Internet Connections

- Clients and servers communicate by sending streams of bytes over **connections**. Each connection is:
 - *Point-to-point*: connects a pair of processes.
 - *Full-duplex*: data can flow in both directions at the same time,
 - *Reliable*: stream of bytes sent by the source is eventually received by the destination in the same order it was sent.
- A **socket** is an endpoint of a connection
 - *Socket address* is an `IPAddress:port` pair
- A **port** is a 16-bit integer that identifies a process:
 - **Ephemeral port**: Assigned automatically by client kernel when client makes a connection request.
 - **Well-known port**: Associated with some **service** provided by a server (e.g., port 80 is associated with Web servers)

Well-known Service Names and Ports

- Popular services have permanently assigned *well-known ports* and corresponding *well-known service names*:
 - echo servers: echo 7
 - ftp servers: ftp 21
 - ssh servers: ssh 22
 - email servers: smtp 25
 - Web servers: http 80
- Mappings between well-known ports and service names is contained in the file `/etc/services` on each Linux machine.

Anatomy of a Connection

- A connection is uniquely identified by the socket addresses of its endpoints (*socket pair*)
 - (cliaddr:cliport, servaddr:servport)

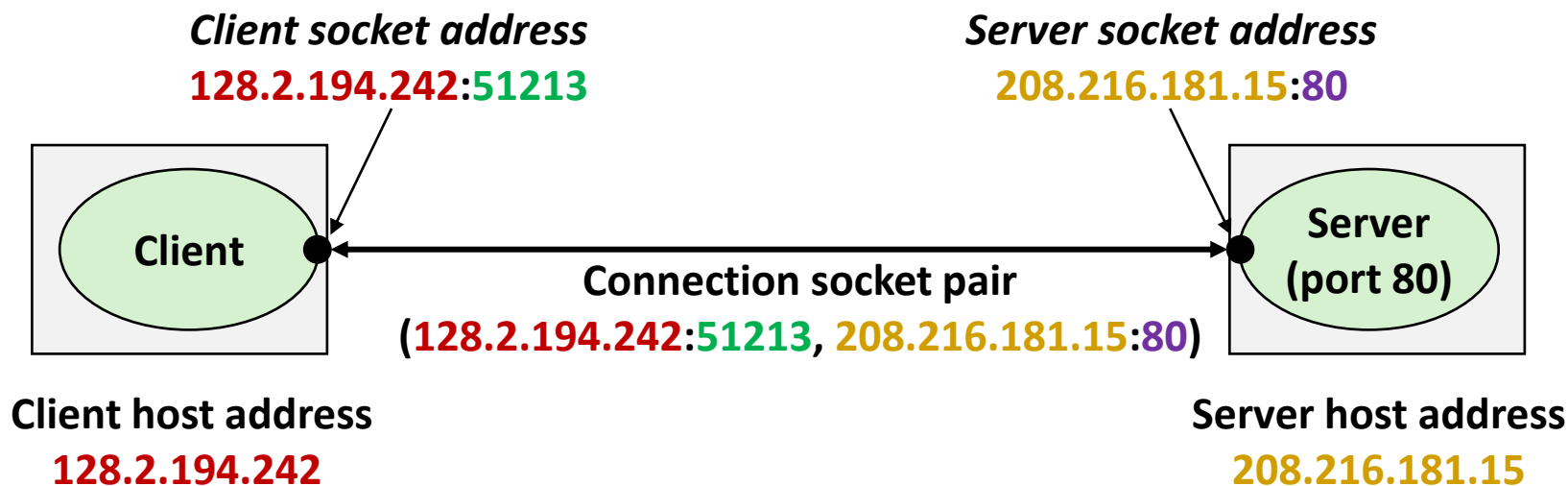

51213 is an ephemeral port allocated by the kernel

80 is a well-known port associated with Web servers

Using Ports to Identify Services

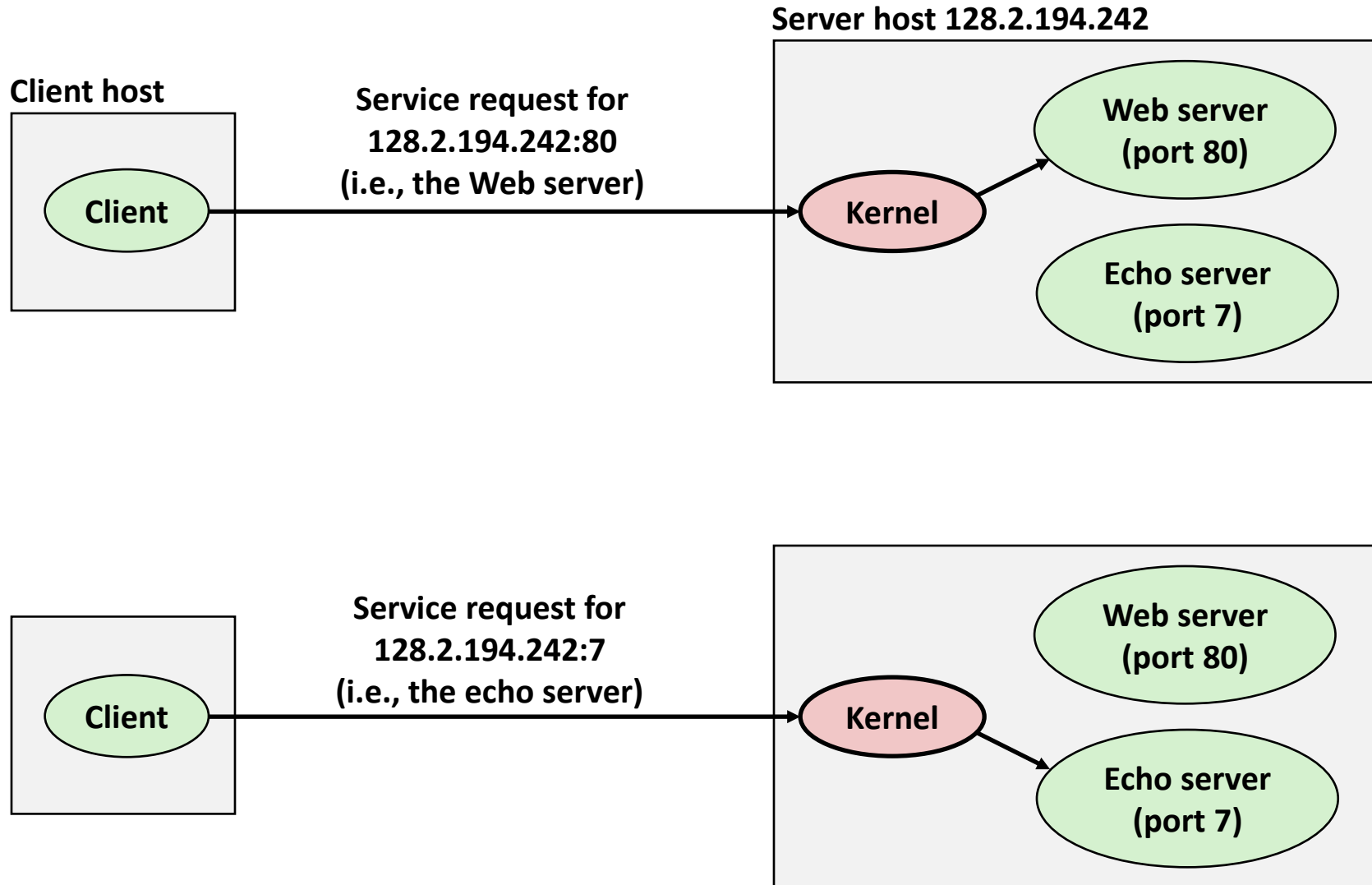

Quiz Time!

Canvas Quiz: Day 20 – Network Programming (part I)

Today

- Network Layers: Bird's Eye View
- Global IP Internet
- **Sockets Interface**

Sockets Interface

- **Set of system-level functions used in conjunction with Unix I/O to build network applications.**
- **Created in the early 80's as part of the original Berkeley distribution of Unix that contained an early version of the Internet protocols.**
- **Available on all modern systems**
 - Unix variants, Windows, OS X, IOS, Android, ARM

Sockets

■ What is a socket?

- To the kernel, a socket is an endpoint of communication
- To an application, a socket is a file descriptor that lets the application read/write from/to the network
 - **Remember:** All Unix I/O devices, including networks, are modeled as files

■ Clients and servers communicate with each other by reading from and writing to socket descriptors



■ The main distinction between regular file I/O and socket I/O is how the application “opens” the socket descriptors

Socket Programming Example

- **Echo server and client**
- **Server**
 - Accepts connection request
 - Repeats back lines as they are typed
- **Client**
 - Requests connection to server
 - Repeatedly:
 - Read line from terminal
 - Send to server
 - Read reply from server
 - Print line to terminal

Echo Server/Client Session Example

Client

```
bambooshark: ./echoclient whaleshark.ics.cs.cmu.edu 6616      (A)
This line is being echoed                                     (B)
This line is being echoed
This one is, too                                           (C)
This one is, too
^D
bambooshark: ./echoclient whaleshark.ics.cs.cmu.edu 6616      (D)
This one is a new connection                               (E)
This one is a new connection
^D
```

Server

```
whaleshark: ./echoserveri 6616
Connected to (BAMBOOSHARK.ICS.CS.CMU.EDU, 33707)          (A)
server received 26 bytes                                   (B)
server received 17 bytes                                   (C)
Connected to (BAMBOOSHARK.ICS.CS.CMU.EDU, 33708)          (D)
server received 29 bytes                                   (E)
```

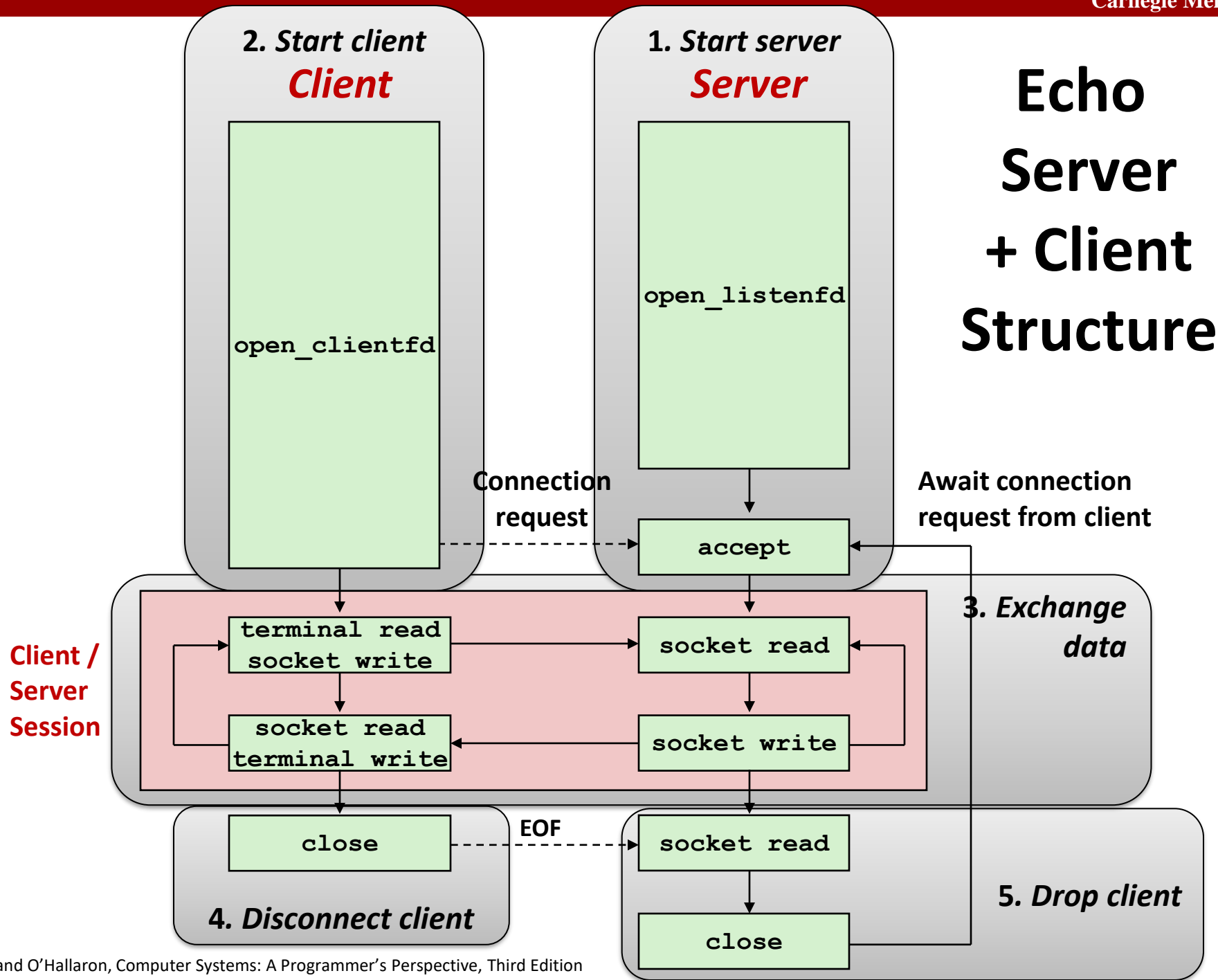

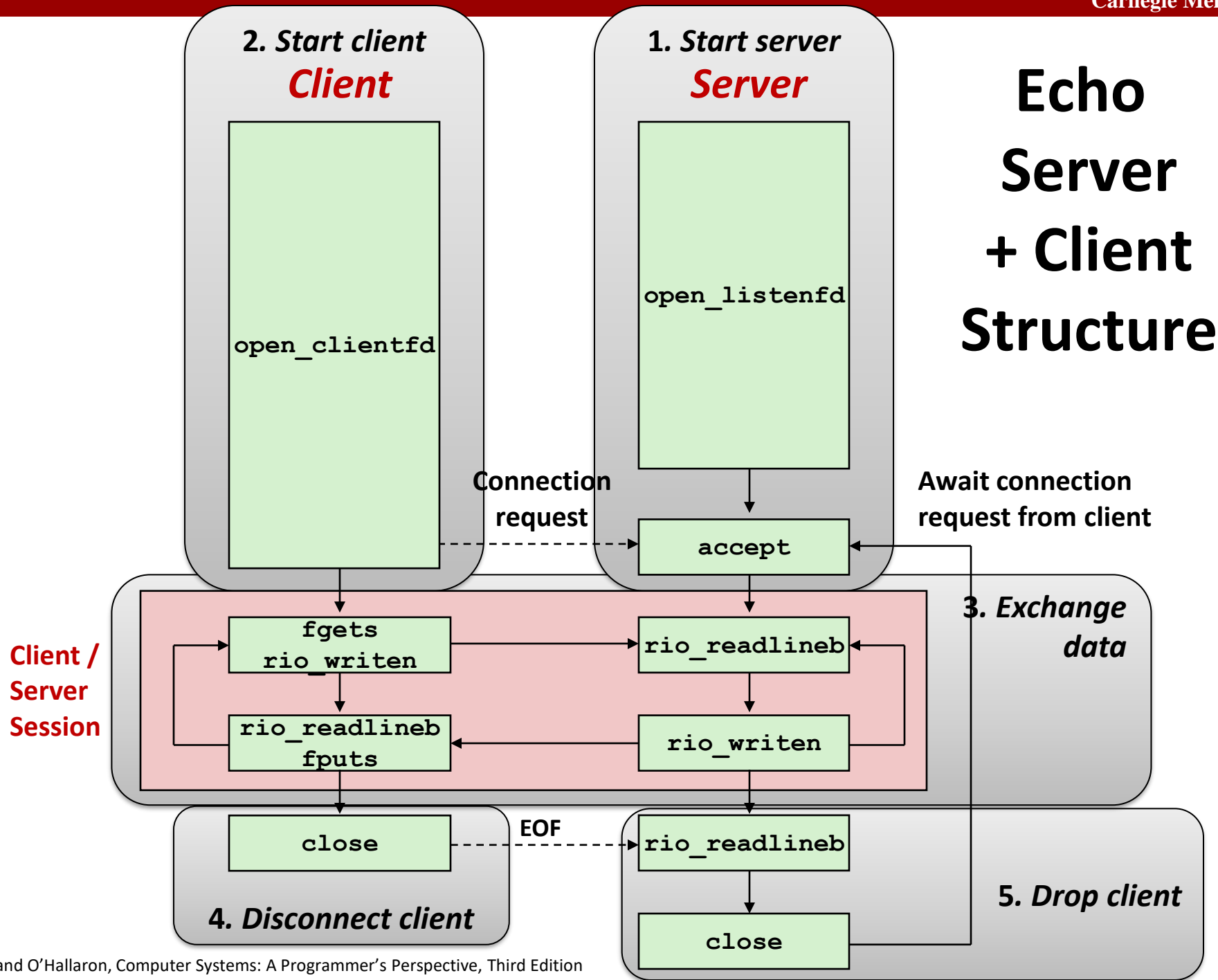

Recall: Unbuffered RIO Input/Output

- Same interface as Unix `read` and `write`
- Especially useful for transferring data on network sockets

```
#include "csapp.h"
```

```
ssize_t rio_readn(int fd, void *usrbuf, size_t n);  
ssize_t rio_writen(int fd, void *usrbuf, size_t n);
```

Return: num. bytes transferred if OK, 0 on EOF (`rio_readn` only), -1 on error

- `rio_readn` returns short count only if it encounters EOF
 - Only use it when you know how many bytes to read
- `rio_writen` never returns a short count
- Calls to `rio_readn` and `rio_writen` can be interleaved arbitrarily on the same descriptor

Recall: Buffered RIO Input Functions

- Efficiently read text lines and binary data from a file partially cached in an internal memory buffer

```
#include "csapp.h"

void rio_readinitb(rio_t *rp, int fd);

ssize_t rio_readlineb(rio_t *rp, void *usrbuf, size_t maxlen);
ssize_t rio_readnb(rio_t *rp, void *usrbuf, size_t n);
```

Return: num. bytes read if OK, 0 on EOF, -1 on error

- `rio_readlineb` reads a *text line* of up to `maxlen` bytes from file `fd` and stores the line in `usrbuf`
 - Especially useful for reading text lines from network sockets
- Stopping conditions
 - `maxlen` bytes read
 - EOF encountered
 - Newline (`'\n'`) encountered

Echo Server: echo function

- The server uses RIO to read and echo text lines until EOF (end-of-file) condition is encountered.
 - EOF condition caused by client calling `close(clientfd)`

```
void echo(int connfd)
{
    size_t n;
    char buf[MAXLINE];
    rio_t rio;

    Rio_readinitb(&rio, connfd);
    while((n = Rio_readlineb(&rio, buf, MAXLINE)) != 0) {
        printf("server received %d bytes\n", (int)n);
        Rio_writen(connfd, buf, n);
    }
}
```

echo.c

Echo Client: Main Routine

```
#include "csapp.h"

int main(int argc, char **argv)
{
    int clientfd;
    char *host, *port, buf[MAXLINE];
    rio_t rio;

    host = argv[1];
    port = argv[2];

    clientfd = Open_clientfd(host, port);
    Rio_readinitb(&rio, clientfd);

    while (Fgets(buf, MAXLINE, stdin) != NULL) {
        Rio_writen(clientfd, buf, strlen(buf));
        Rio_readlineb(&rio, buf, MAXLINE);
        Fputs(buf, stdout);
    }
    Close(clientfd);
    exit(0);
}
```

echoclient.c

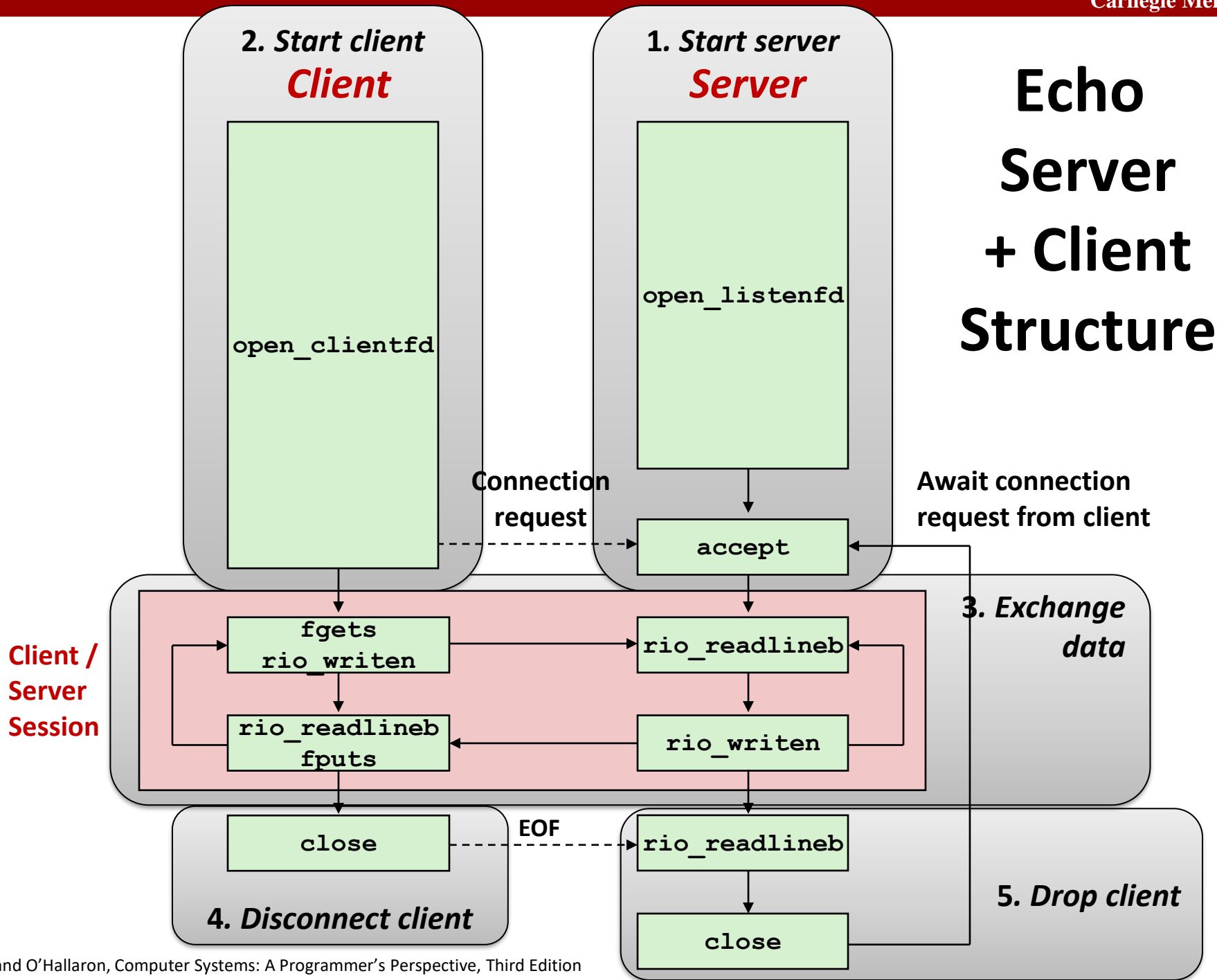

Iterative Echo Server: Main Routine

```
#include "csapp.h"
void echo(int connfd);

int main(int argc, char **argv)
{
    int listenfd, connfd;
    socklen_t clientlen;
    struct sockaddr_storage clientaddr; /* Enough room for any addr */
    char client_hostname[MAXLINE], client_port[MAXLINE];

    listenfd = Open_listenfd(argv[1]);
    while (1) {
        clientlen = sizeof(struct sockaddr_storage); /* Important! */
        connfd = Accept(listenfd, (SA *)&clientaddr, &clientlen);
        Getnameinfo((SA *)&clientaddr, clientlen,
                    client_hostname, MAXLINE, client_port, MAXLINE, 0);
        printf("Connected to (%s, %s)\n", client_hostname, client_port);
        echo(connfd);
        Close(connfd);
    }
    exit(0);
}
```

echoserveri.c

Socket Address Structures

■ Generic socket address:

- For address arguments to **connect**, **bind**, and **accept** (*next lecture*)
- Necessary only because C did not have generic (**void ***) pointers when the sockets interface was designed
- For casting convenience, we adopt the Stevens convention:

```
typedef struct sockaddr SA;
```

```
struct sockaddr {  
    uint16_t  sa_family;    /* Protocol family */  
    char      sa_data[14]; /* Address data */  
};
```

sa_family



Family Specific

Socket Address Structures

■ Internet (IPv4) specific socket address:

- Must cast (`struct sockaddr_in *`) to (`struct sockaddr *`) for functions that take socket address arguments.

```

struct sockaddr_in {
    uint16_t      sin_family; /* Protocol family (always AF_INET) */
    uint16_t      sin_port;  /* Port num in network byte order */
    struct in_addr sin_addr;  /* IP addr in network byte order */
    unsigned char sin_zero[8]; /* Pad to sizeof(struct sockaddr) */
};

```

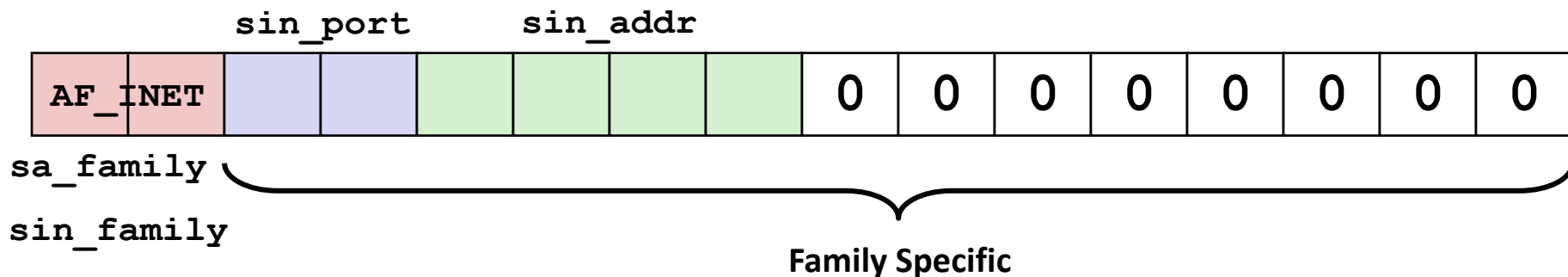

Host and Service Conversion: `getaddrinfo`

- `getaddrinfo` is the modern way to convert string representations of hostnames, host addresses, ports, and service names to socket address structures.
 - Replaces obsolete `gethostbyname` and `getservbyname` funcs.
- **Advantages:**
 - Reentrant (can be safely used by threaded programs).
 - Allows us to write portable protocol-independent code
 - Works with both IPv4 and IPv6
- **Disadvantages**
 - Somewhat complex
 - Fortunately, a small number of usage patterns suffice in most cases.

Host and Service Conversion: `getaddrinfo`

```
int getaddrinfo(const char *host,          /* Hostname or address */
               const char *service,      /* Port or service name */
               const struct addrinfo *hints, /* Input parameters */
               struct addrinfo **result); /* Output linked list */

void freeaddrinfo(struct addrinfo *result); /* Free linked list */

const char *gai_strerror(int errcode);    /* Return error msg */
```

- Given `host` and `service`, `getaddrinfo` returns `result` that points to a linked list of `addrinfo` structs, each of which points to a corresponding socket address struct, and which contains arguments for the sockets interface functions.
- **Helper functions:**
 - `freeaddrinfo` frees the entire linked list.
 - `gai_strerror` converts error code to an error message.

Linked List Returned by `getaddrinfo`

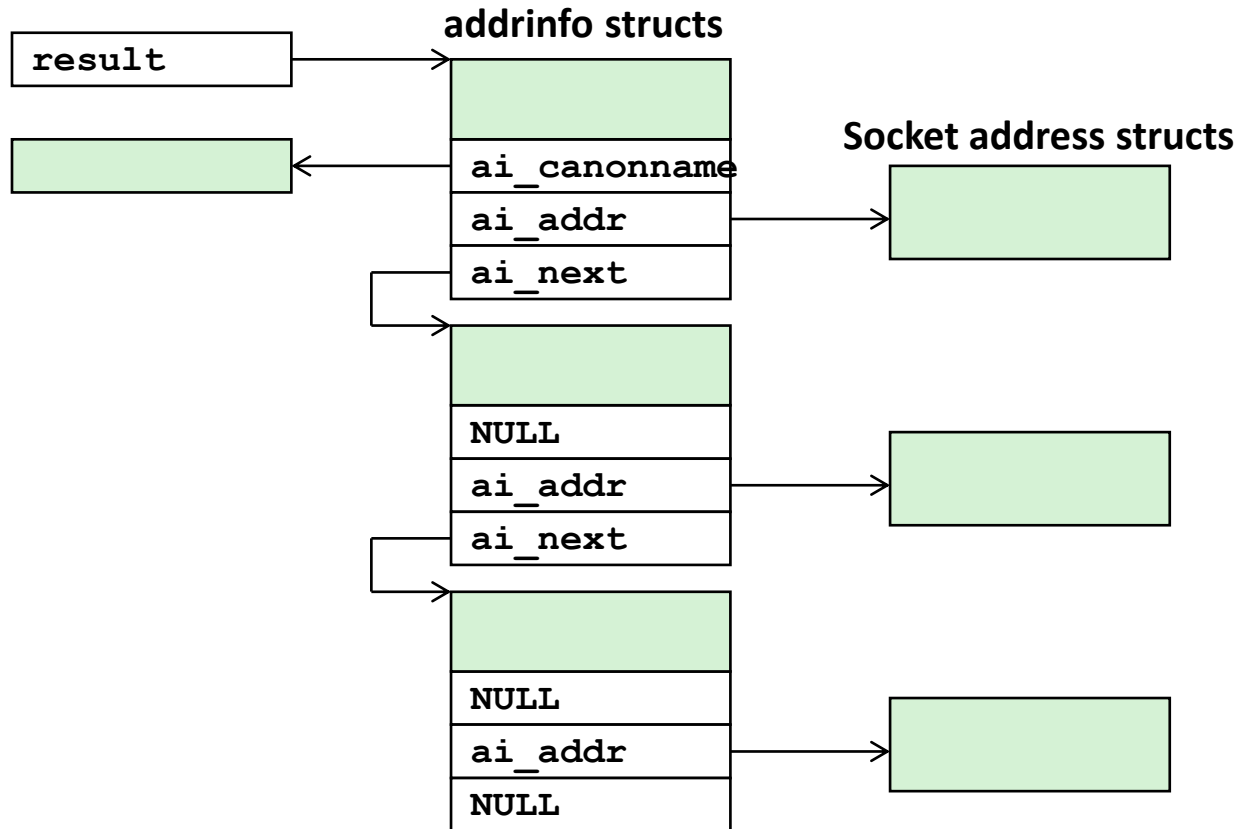

addrinfo Struct

```
struct addrinfo {
    int          ai_flags;      /* Hints argument flags */
    int          ai_family;    /* First arg to socket function */
    int          ai_socktype;  /* Second arg to socket function */
    int          ai_protocol;  /* Third arg to socket function */
    char        *ai_canonname; /* Canonical host name */
    size_t       ai_addrlen;   /* Size of ai_addr struct */
    struct sockaddr *ai_addr;  /* Ptr to socket address structure */
    struct addrinfo *ai_next;  /* Ptr to next item in linked list */
};
```

- Each `addrinfo` struct returned by `getaddrinfo` contains arguments that can be passed directly to `socket` function.
- Also points to a socket address struct that can be passed directly to `connect` and `bind` functions .

(`socket`, `connect`, `bind` to be discussed next lecture)

Host and Service Conversion: `getnameinfo`

- `getnameinfo` is the inverse of `getaddrinfo`, converting a socket address to the corresponding host and service.
 - Replaces obsolete `gethostbyaddr` and `getservbyport` funcs.
 - Reentrant and protocol independent.

```
int getnameinfo(const SA *sa, socklen_t salen, /* In: socket addr */
               char *host, size_t hostlen, /* Out: host */
               char *serv, size_t servlen, /* Out: service */
               int flags); /* optional flags */
```

Conversion Example

```
#include "csapp.h"

int main(int argc, char **argv)
{
    struct addrinfo *p, *listp, hints;
    char buf[MAXLINE];
    int rc, flags;

    /* Get a list of addrinfo records */
    memset(&hints, 0, sizeof(struct addrinfo));
    // hints.ai_family = AF_INET;          /* IPv4 only */
    hints.ai_socktype = SOCK_STREAM; /* Connections only */
    if ((rc = getaddrinfo(argv[1], NULL, &hints, &listp)) != 0) {
        fprintf(stderr, "getaddrinfo error: %s\n", gai_strerror(rc));
        exit(1);
    }
}
```

hostinfo.c

Conversion Example (cont)

```
/* Walk the list and display each IP address */
flags = NI_NUMERICHOST; /* Display address instead of name */
for (p = listp; p; p = p->ai_next) {
    Getnameinfo(p->ai_addr, p->ai_addrlen,
                buf, MAXLINE, NULL, 0, flags);
    printf("%s\n", buf);
}

/* Clean up */
Freeaddrinfo(listp);

exit(0);
}
```

hostinfo.c

Running hostinfo

```
whaleshark> ./hostinfo localhost  
127.0.0.1
```

```
whaleshark> ./hostinfo whaleshark.ics.cs.cmu.edu  
128.2.210.175
```

```
whaleshark> ./hostinfo twitter.com  
199.16.156.230  
199.16.156.38  
199.16.156.102  
199.16.156.198
```

```
whaleshark> ./hostinfo google.com  
172.217.15.110  
2607:f8b0:4004:802::200e
```

Today

- Network Layers
- Global IP Internet
- Sockets Interface

Next time

- Using `getaddrinfo` for host and service conversion
- Writing clients and servers
- Writing Web servers!

Additional slides

Basic Internet Components

■ Internet backbone:

- collection of routers (nationwide or worldwide) connected by high-speed point-to-point networks

■ Internet Exchange Points (IXP):

- router that connects multiple backbones (often referred to as peers)
- Also called Network Access Points (NAP)

■ Regional networks:

- smaller backbones that cover smaller geographical areas (e.g., cities or states)

■ Point of presence (POP):

- machine that is connected to the Internet

■ Internet Service Providers (ISPs):

- provide dial-up or direct access to POPs

Internet Connection Hierarchy

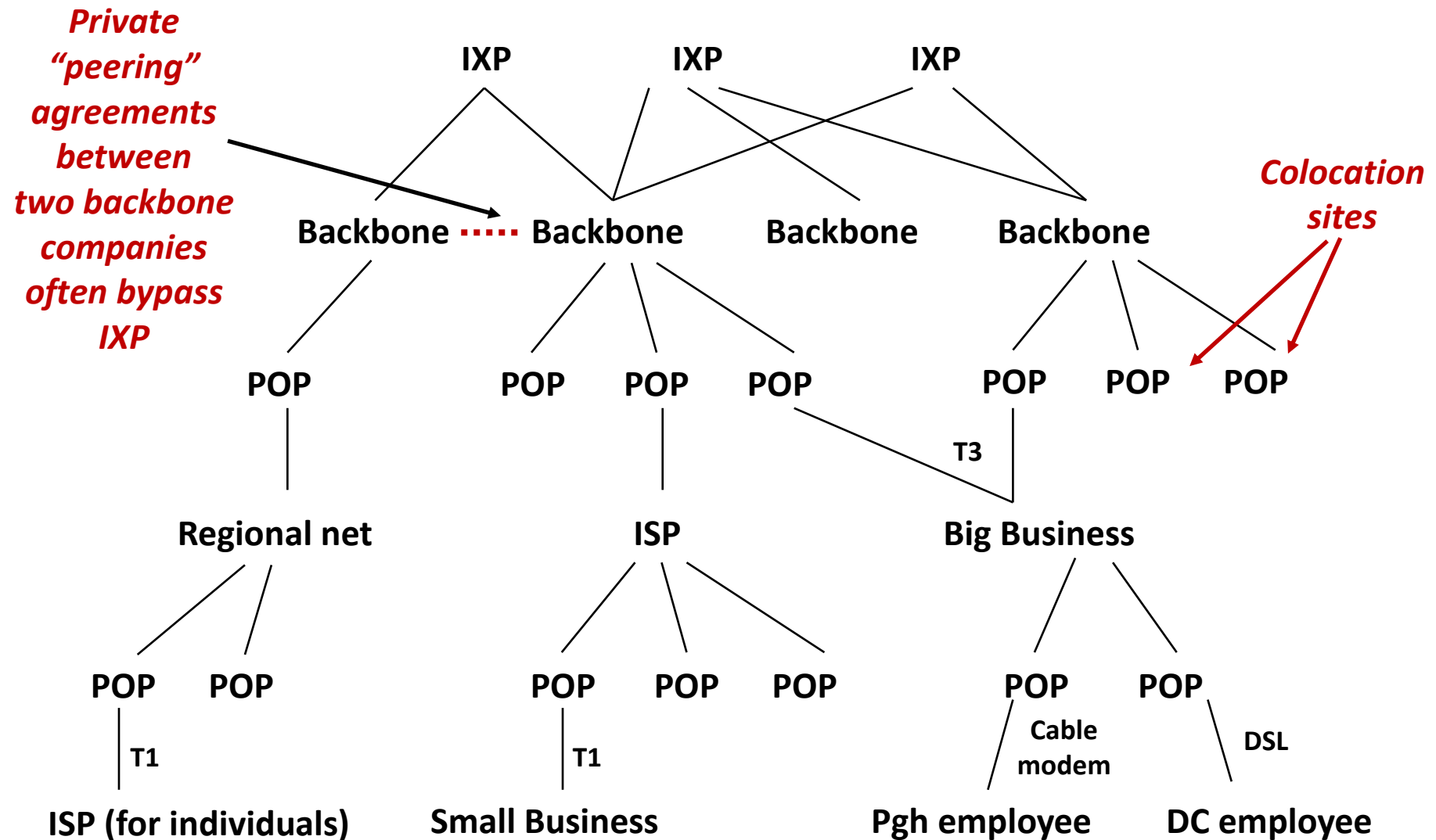

IP Address Structure

■ IP (V4) Address space divided into classes:

	0	1	2	3	8	16	24	31	
Class A	0	Net ID			Host ID				
Class B	1	0	Net ID			Host ID			
Class C	1	1	0	Net ID			Host ID		
Class D	1	1	1	0	Multicast address				
Class E	1	1	1	1	Reserved for experiments				

■ Network ID Written in form w.x.y.z/n

- n = number of bits in host address
- E.g., CMU written as 128.2.0.0/16
 - Class B address

■ Unrouted (private) IP addresses:

10.0.0.0/8 172.16.0.0/12 192.168.0.0/16

Evolution of Internet

■ Original Idea

- Every node on Internet would have unique IP address
 - Everyone would be able to talk directly to everyone
- No secrecy or authentication
 - Messages visible to routers and hosts on same LAN
 - Possible to forge source field in packet header

■ Shortcomings

- There aren't enough IP addresses available
- Don't want everyone to have access or knowledge of all other hosts
- Security issues mandate secrecy & authentication

Evolution of Internet: Naming

■ Dynamic address assignment

- Most hosts don't need to have known address
 - Only those functioning as servers
- DHCP (Dynamic Host Configuration Protocol)
 - Local ISP assigns address for temporary use

■ Example:

- Laptop at CMU (wired connection)
 - IP address 128.2.213.29 (**bryant-tp4.cs.cmu.edu**)
 - Assigned statically
- Laptop at home
 - IP address 192.168.1.5
 - Only valid within home network

Evolution of Internet: Firewalls

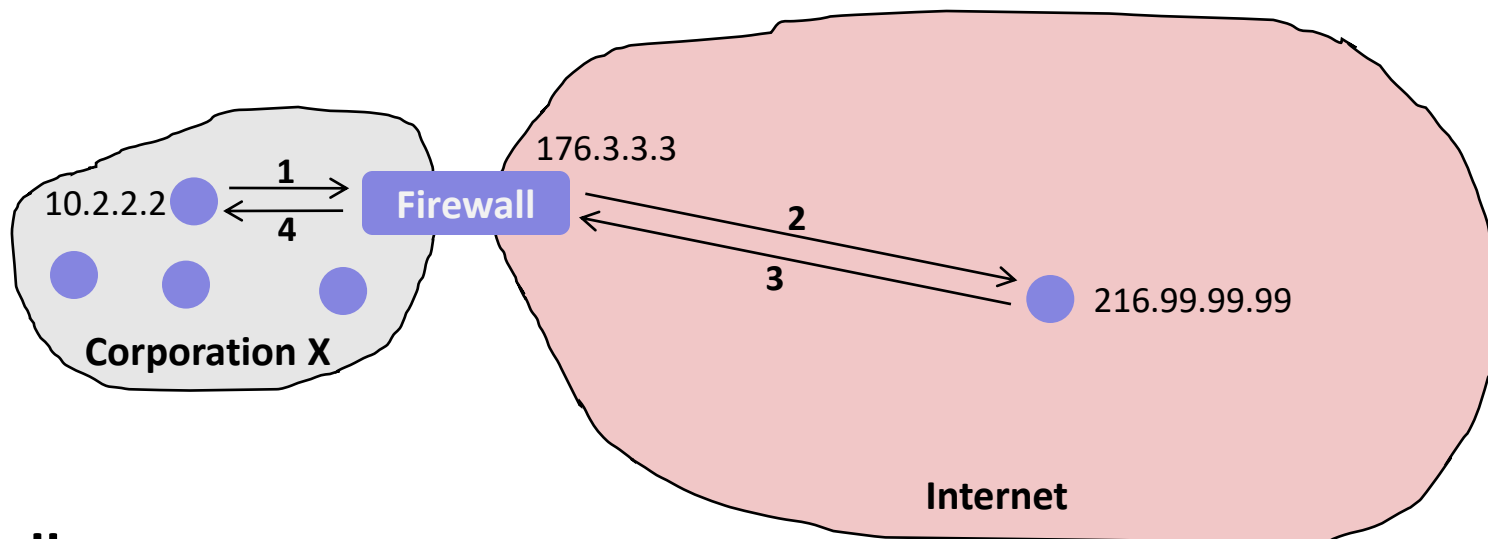

■ Firewalls

- Hides organizations nodes from rest of Internet
- Use local IP addresses within organization
- For external service, provides proxy service
 1. Client request: src=10.2.2.2, dest=216.99.99.99
 2. Firewall forwards: src=176.3.3.3, dest=216.99.99.99
 3. Server responds: src=216.99.99.99, dest=176.3.3.3
 4. Firewall forwards response: src=216.99.99.99, dest=10.2.2.2

Hardware Organization of a Network Host

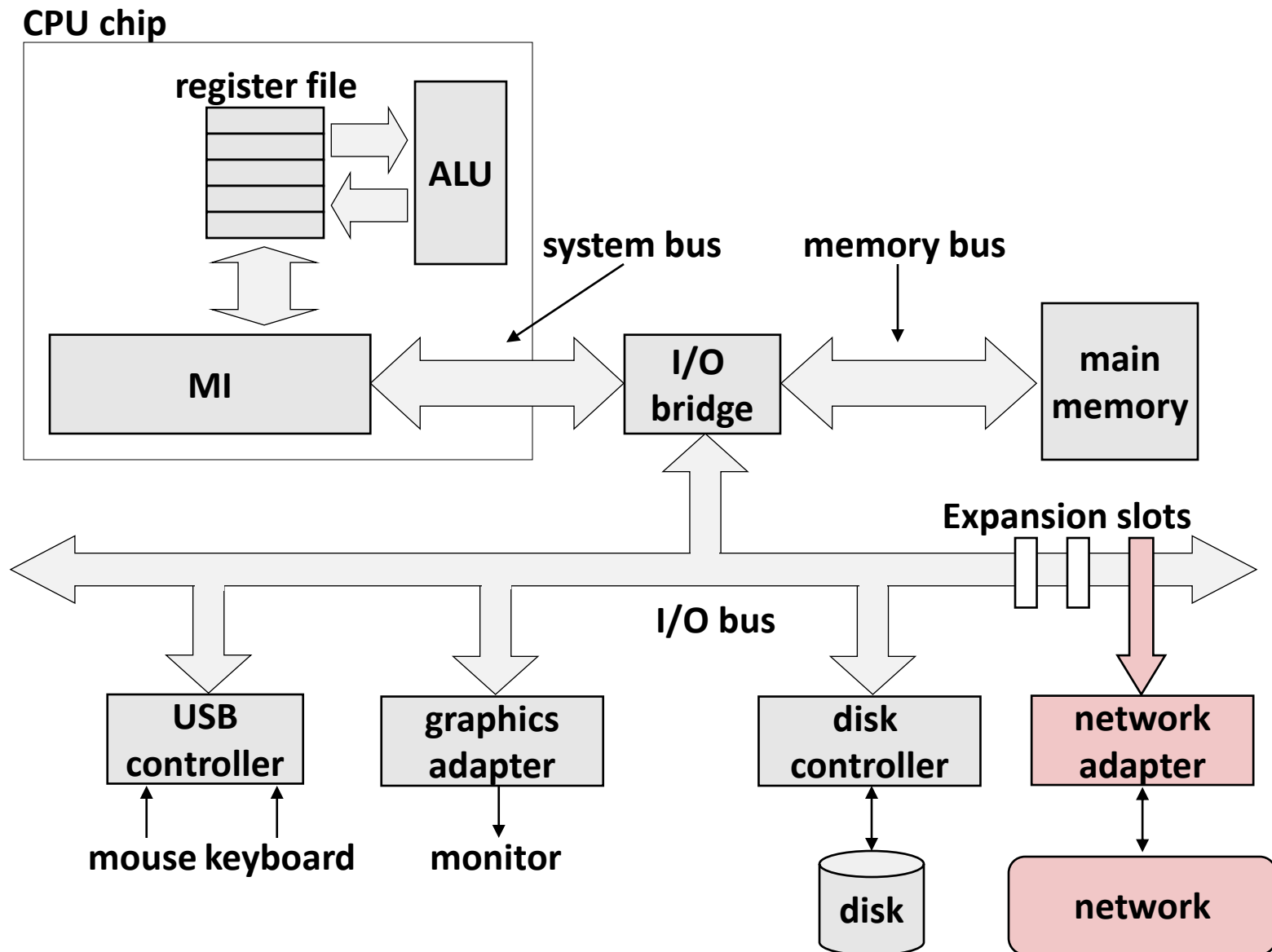

Computer Networks

- A ***network*** is a hierarchical system of boxes and wires organized by geographical proximity
 - BAN (Body Area Network) spans devices carried / worn on body
 - SAN* (System Area Network) spans cluster or machine room
 - Switched Ethernet, Quadrics QSW, ...
 - LAN (Local Area Network) spans a building or campus
 - Ethernet is most prominent example
 - WAN (Wide Area Network) spans country or world
 - Typically high-speed point-to-point phone lines
- An ***internetwork (internet)*** is an interconnected set of networks
 - The Global IP Internet (uppercase “I”) is the most famous example of an internet (lowercase “i”)
- **Let’s see how an internet is built from the ground up**

* Not to be confused with a Storage Area Network

Lowest Level: Ethernet Segment

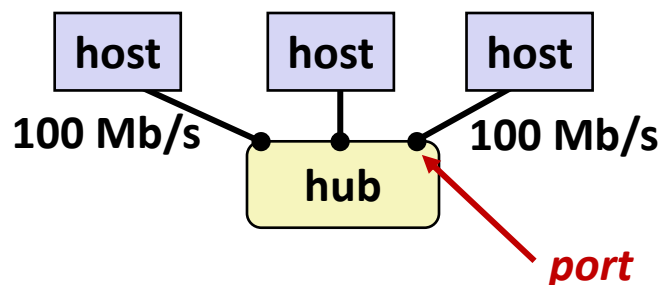

- Ethernet segment consists of a collection of *hosts* connected by wires (twisted pairs) to a *hub*
 - Spans room or floor in a building
 - Operation
 - Each Ethernet adapter has a unique 48-bit address (MAC address)
 - E.g., 00:16:ea:e3:54:e6
 - Hosts send bits to any other host in chunks called *frames*
 - Hub slavishly copies each bit from each port to every other port
 - Every host sees every bit
- [Note: Hubs are obsolete. Bridges (switches, routers) became cheap enough to replace them]

Next Level: Bridged Ethernet Segment

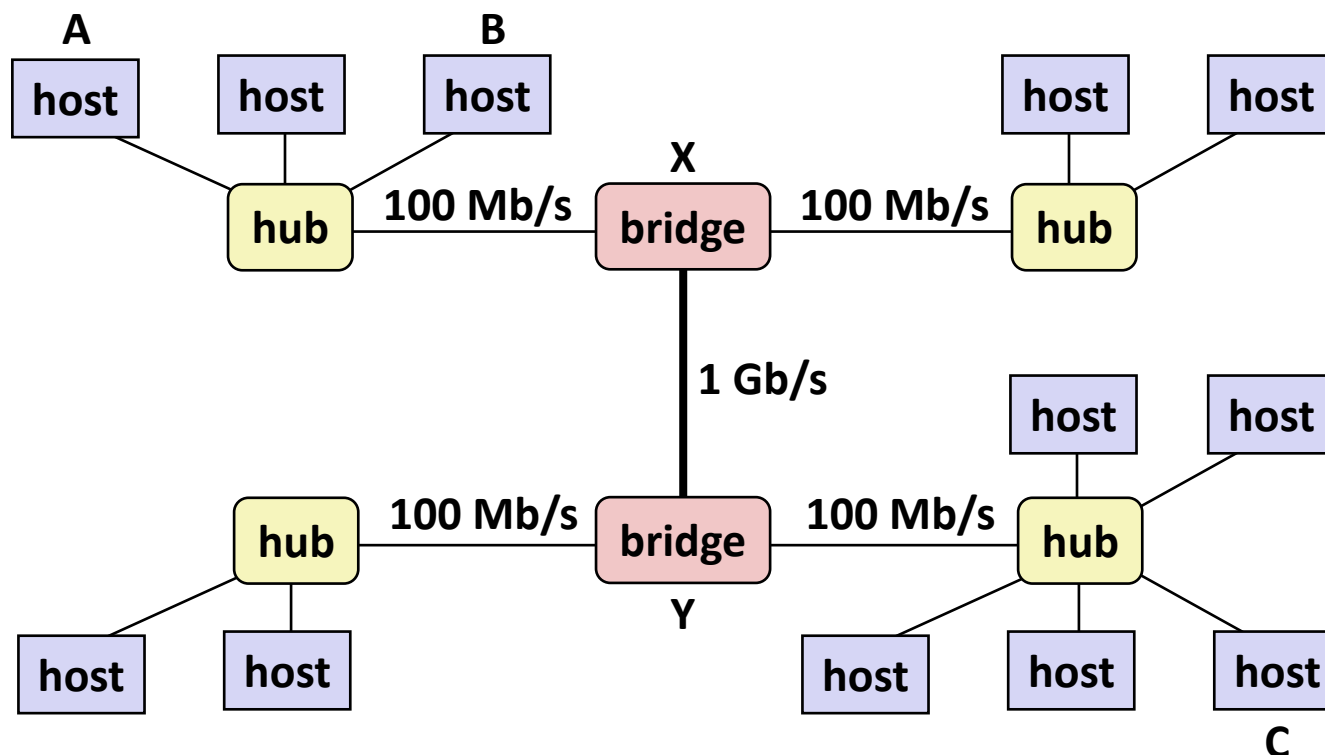

- Spans building or campus
- Bridges cleverly learn which hosts are reachable from which ports and then selectively copy frames from port to port

Conceptual View of LANs

- For simplicity, hubs, bridges, and wires are often shown as a collection of hosts attached to a single wire:



Next Level: internets

- Multiple incompatible LANs can be physically connected by specialized computers called *routers*
- The connected networks are called an *internet* (lower case)

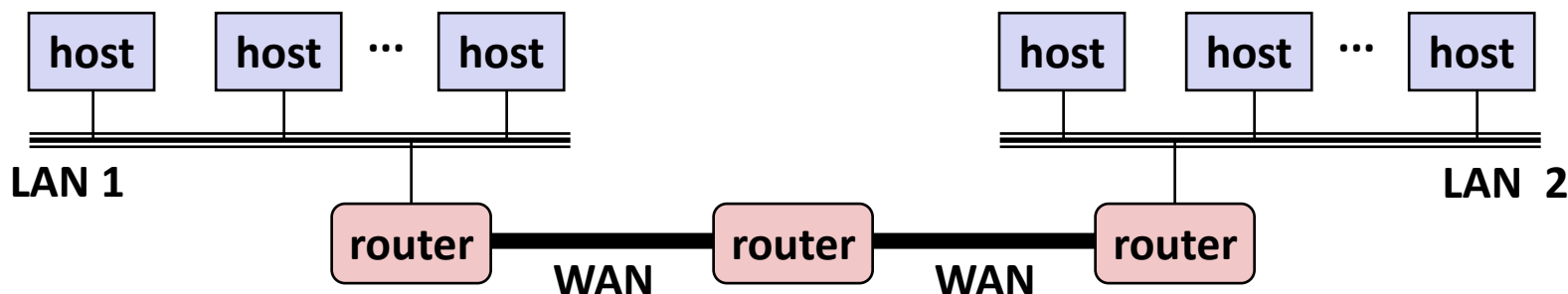

LAN 1 and LAN 2 might be completely different, totally incompatible (e.g., Ethernet, Fibre Channel, 802.11, T1-links, DSL, ...)*

Logical Structure of an internet

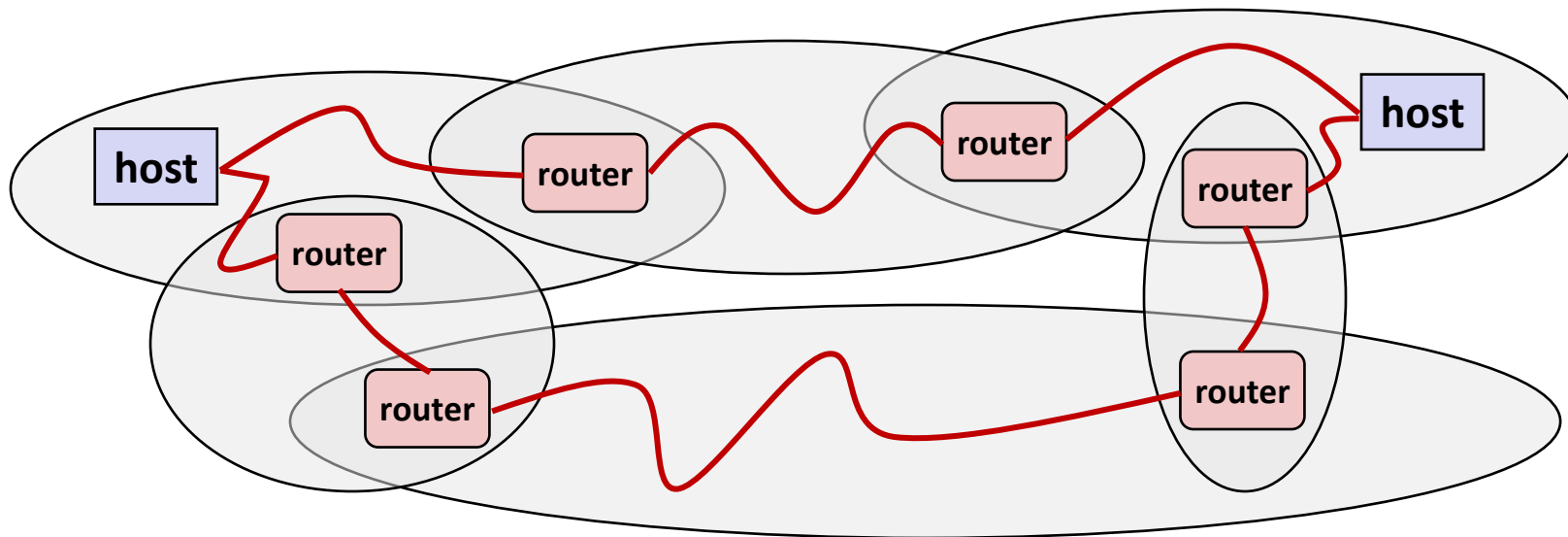

■ Ad hoc interconnection of networks

- No particular topology
- Vastly different router & link capacities

■ Send packets from source to destination by hopping through networks

- Router forms bridge from one network to another
- Different packets may take different routes

The Notion of an internet Protocol

- How is it possible to send bits across incompatible LANs and WANs?
- Solution: *protocol* software running on each host and router
 - Protocol is a set of rules that governs how hosts and routers should cooperate when they transfer data from network to network.
 - Smooths out the differences between the different networks

What Does an internet Protocol Do?

■ Provides a *naming scheme*

- An internet protocol defines a uniform format for *host addresses*
- Each host (and router) is assigned at least one of these internet addresses that uniquely identifies it

■ Provides a *delivery mechanism*

- An internet protocol defines a standard transfer unit (*packet*)
- Packet consists of *header* and *payload*
 - Header: contains info such as packet size, source and destination addresses
 - Payload: contains data bits sent from source host

Transferring internet Data Via Encapsulation

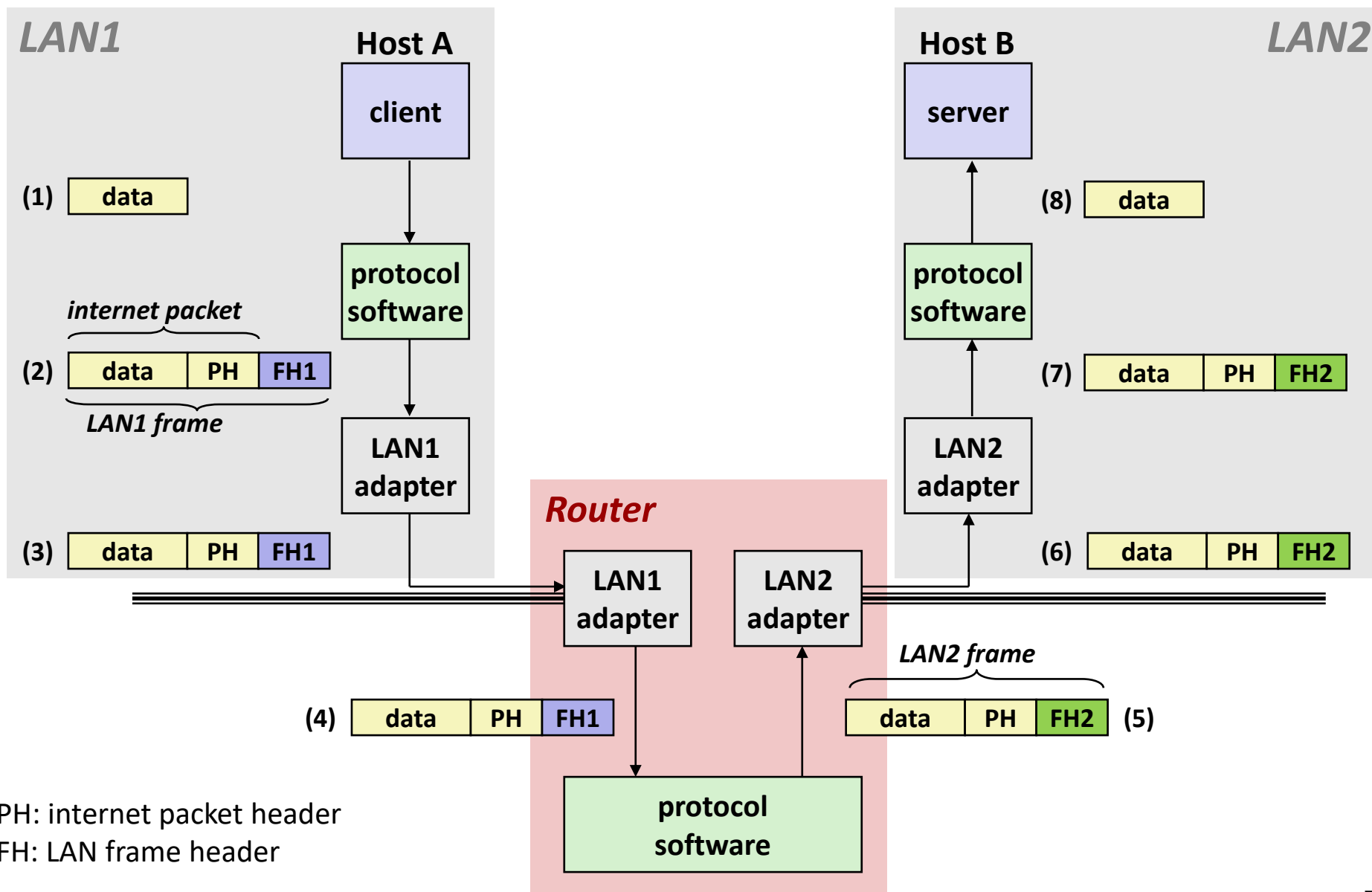

Other Issues

- **We are glossing over a number of important questions:**
 - What if different networks have different maximum frame sizes? (segmentation)
 - How do routers know where to forward frames?
 - How are routers informed when the network topology changes?
 - What if packets get lost?

- **These (and other) questions are addressed by the area of systems known as *computer networking***