

15-110 Recitation Week 9

Reminders

- Check5 due Monday 11/06 at Noon
- Exam 2 on Wednesday 11/08
 - Small groups this weekend!
 - Look out for review sessions!
- HW4 revisions are due Tuesday 11/07 at Noon
- [recitation feedback form](#)

Overview

- mapReduce
- pipelining
- Internet Questions
- Security Review
- Exam Review

Problems

MAPREDUCE

Recall the components of a mapReduce algorithm.

Suppose we make a mapReduce function to count the number of files that have an even number of occurrences of the string “Trick or Treat!”. Define the mapper, reducer, and manager actions.

Mapper:
Reducer:
Manager:

PIPELINING

You just started your summer job working at Bens Burger ! It’s the daily 1 hour lunch rush and you are trying to figure out what the most efficient way of churning out burgers is. Preparing the burgers for customers takes 4 steps that must be performed in this order: grilling burgers takes 5 minutes (G), toasting buns takes 2 minutes (T), placing vegetables takes 2 minutes (V), and dressing condiments takes 1 minute (C). You start off by just making the burgers one after another.

How many burgers can you fully complete in the 1 hour lunch rush? _____

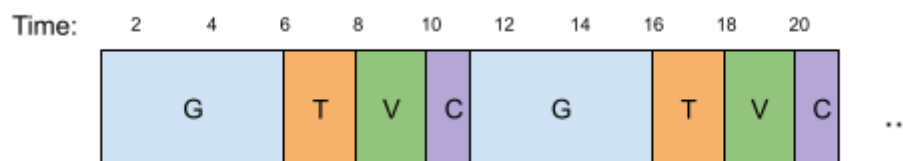

You and your friend just learned about pipelining in 15110 and your friend proposes the following pipelines to speed up burger production. Your friend asks you to check over the pipelines they made and see if there are any errors. For the following pipelines identify the error if there is one or say no error if there is none. (Assume you have as many workers and as much equipment as you need to build burgers)

Option 1)

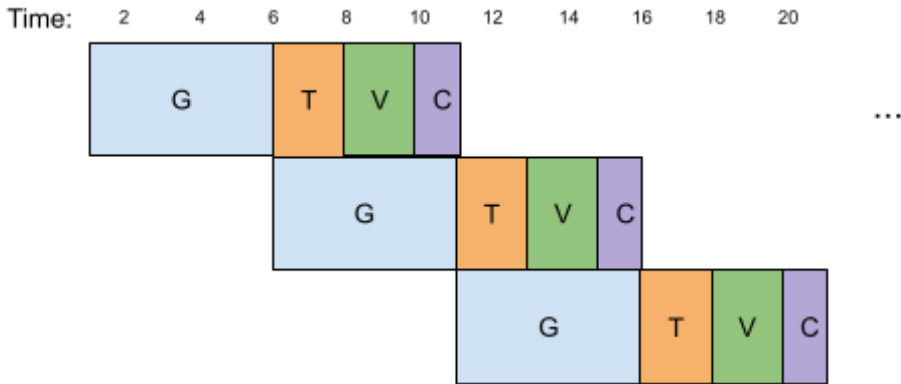

Option 2)

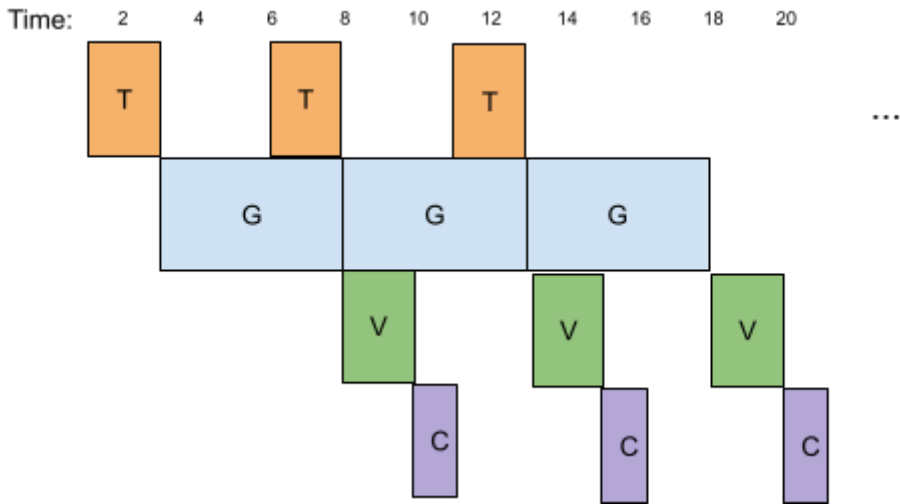



Option 3)

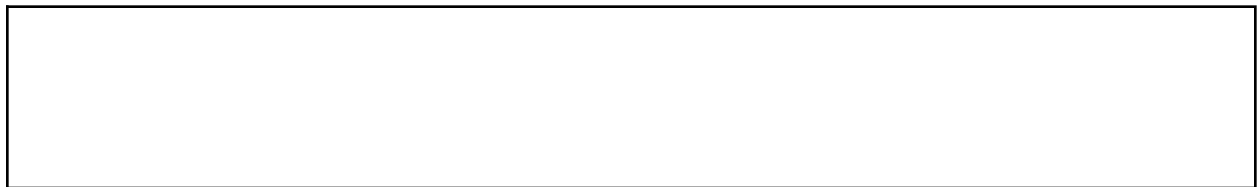
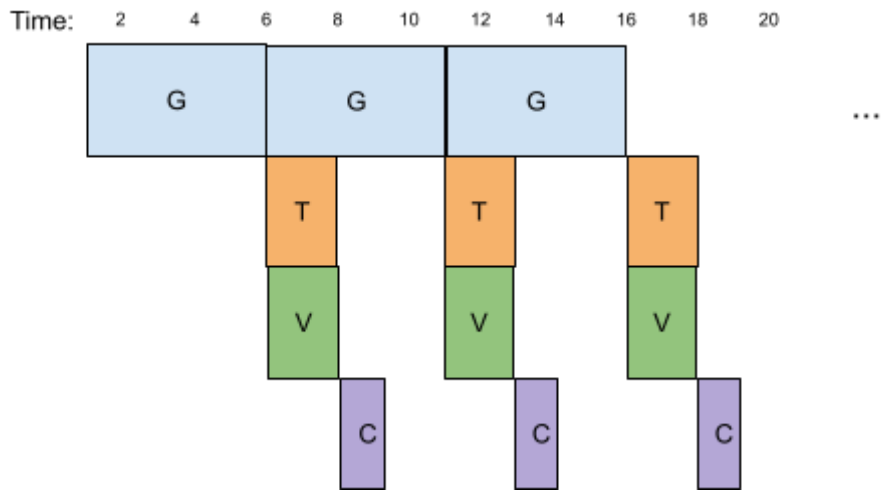

Option 4)

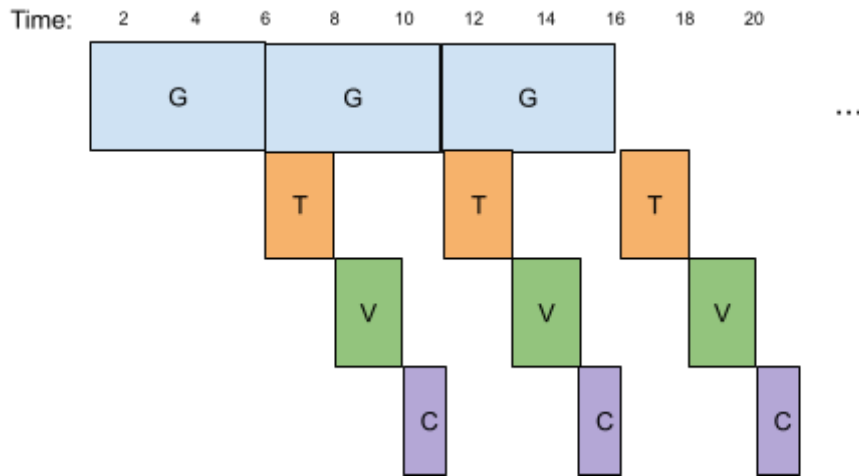

Using the correct pipelining strategy, how many burgers will you be able to make during the lunch rush?

With the correct pipelining strategy, how many workers do we need? With this number of workers, does pipelining allow for faster burger production? What are the tradeoffs?

Number of workers:

Additional answers/notes:

Quick Internet Questions

True or False?

The internet is governed by a series of protocols, HTTP is one of them.

To get the IP address of a website using a URL, my computer uses DNS

IP addresses can be static or dynamic

All packets routed back to your computer from a website are guaranteed to be routed through the same wire.

Browsers retrieve packets from the internet and organize them into web pages.

Security Review

Describe the two main types of authentication.

What makes RSA nearly impossible to break?

Match the descriptions below to the corresponding types of security attack:

Every student at CMU goes to SIO at the same time to check their schedules

Answer: _____

A student hacks a CMU router and looks at the packets for their roommate's andrew ID and password to send prank emails from their accounts

Answer: _____

Exam Review

Topics:

- Recursion
- Dictionaries
- Hashing
- Aliasing

Recursion

Write the recursive function `sumMultiples(L, k)` that returns the sum of all numbers in the list that are divisible by `k`. For example, `sumMultiples([1,2,3,4,5], 2)` should return `2 + 4 => 6`

Dictionaries

Quick questions

How do you add a key value pair to the dictionary: _____

How do you check if something is in a dictionary: _____

How do you loop over a dictionary d: _____

What would be printed after these lines of code

```
d = {"a":5, 10:10, "c":15, "hello":22, 7:"wow"}
```

```
for k in d:
```

```
    if type(d[k]) == int:
```

```
        print(k)
```

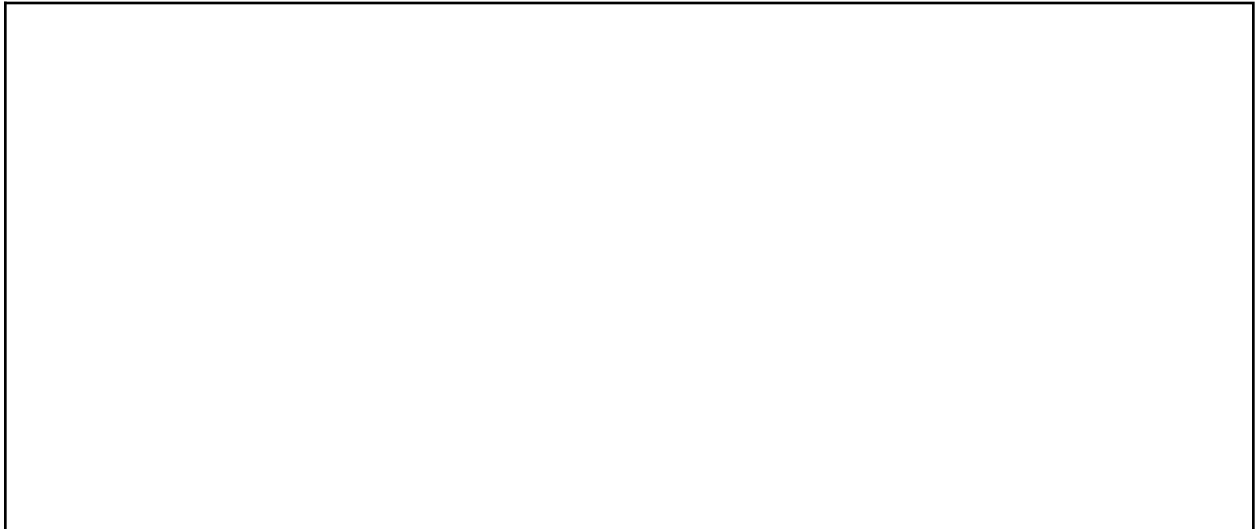

Hashing



Aliasing

What will each of these variables be assigned to after we run this block of code?

```
A = [1,2,3]
```

```
B = A[1:]
```

```
C = A
```

```
B.append(A[0]*2)
```

```
C.extend( [4,5,6] )
```

```
C.append(7)
```

```
A.pop(0)
```

```
C.pop(0)
```

```
print(A,B,C)
```

