

# Neural Networks

## Representations

# Learning in the net

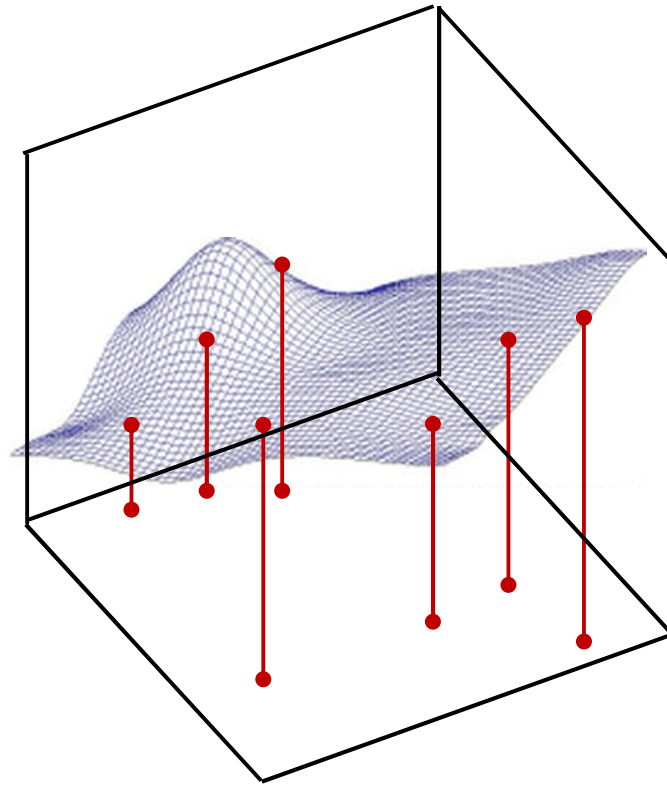

- Problem: Given a collection of input-output pairs, learn the function

# Learning for classification

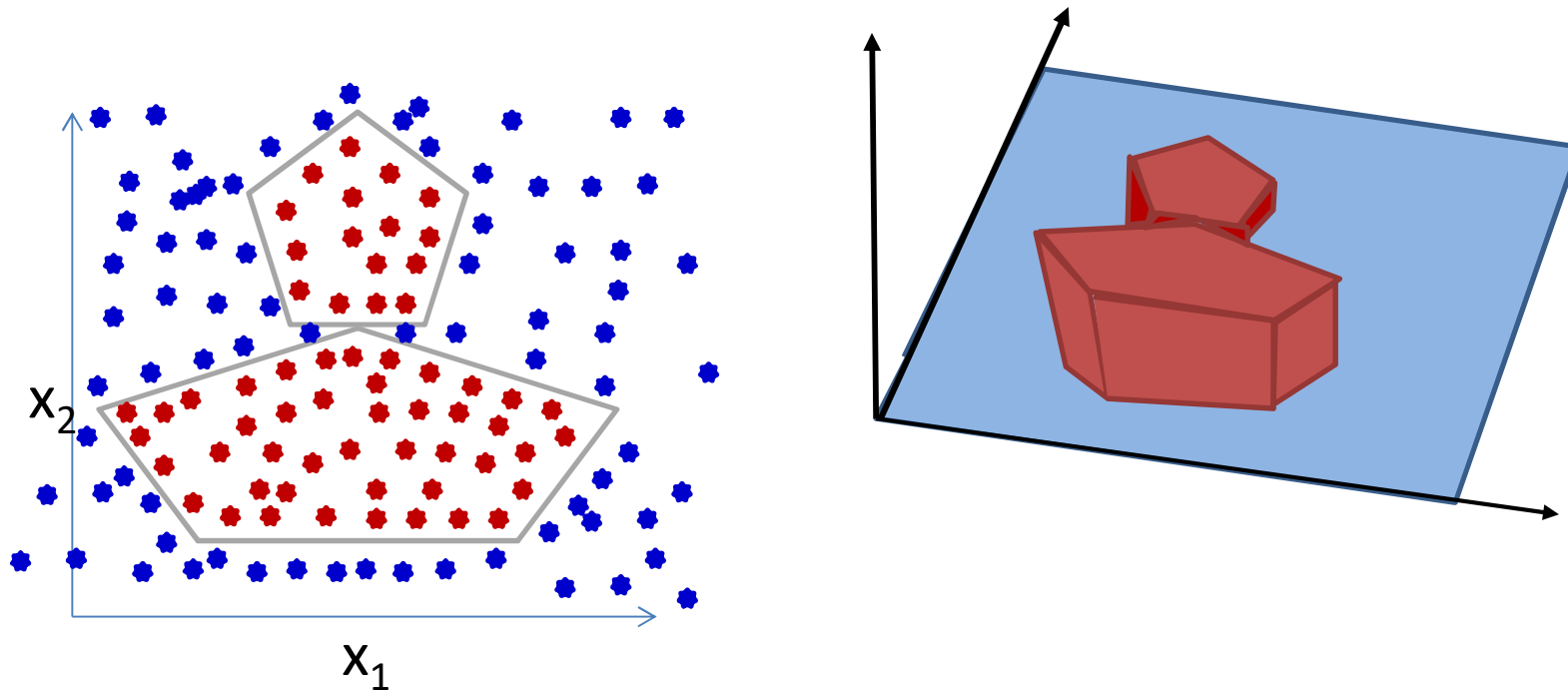

- When the net must learn to classify..
  - Learn the classification boundaries that separate the training instances

# Learning for classification

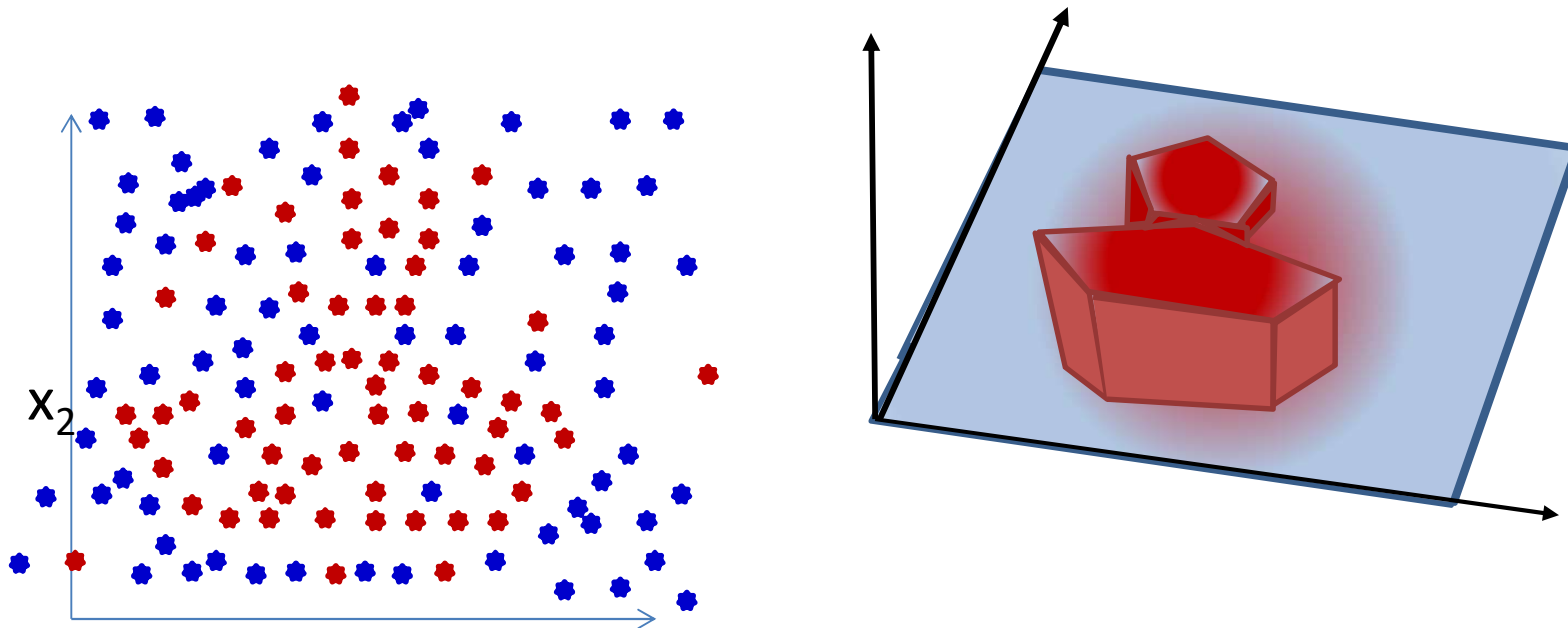

- In reality
  - In general not really cleanly separated
    - So what is the function we learn?

# In reality: Trivial linear example

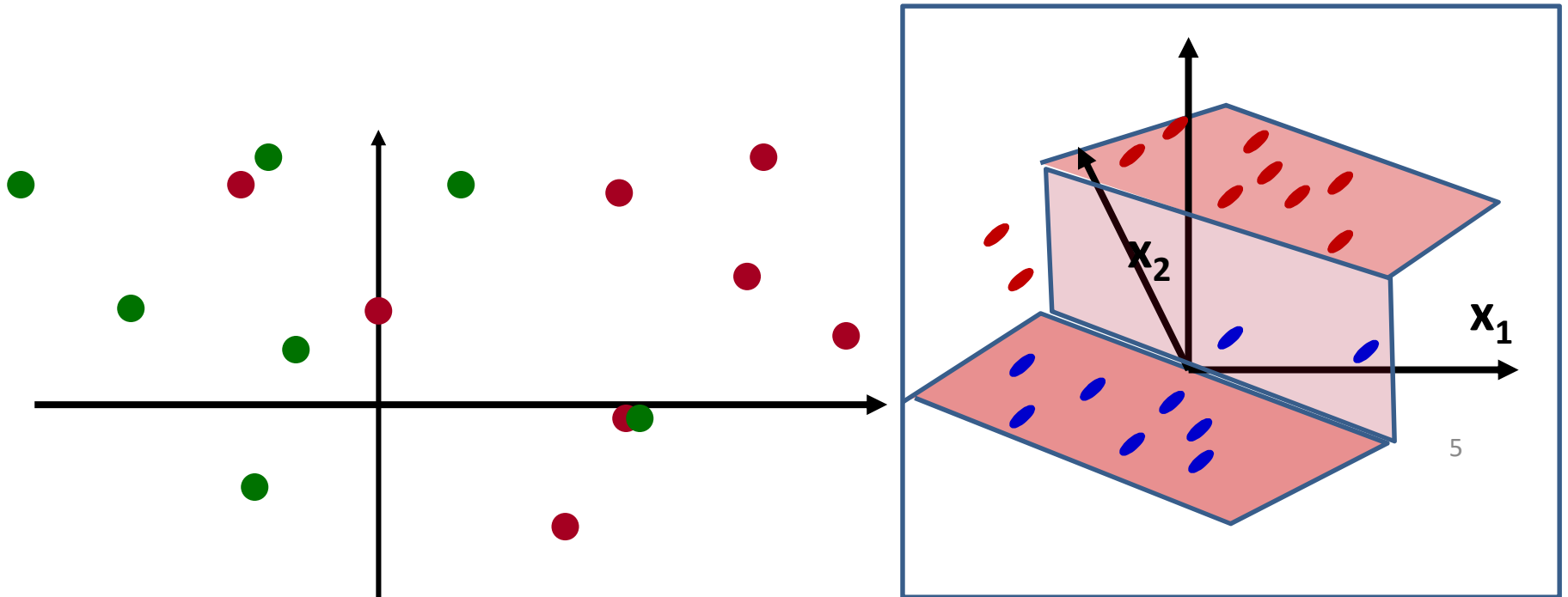

- Two-dimensional example
  - Blue dots (on the floor) on the “red” side
  - Red dots (suspended at  $Y=1$ ) on the “blue” side
  - No line will cleanly separate the two colors

# Non-linearly separable data: 1-D example

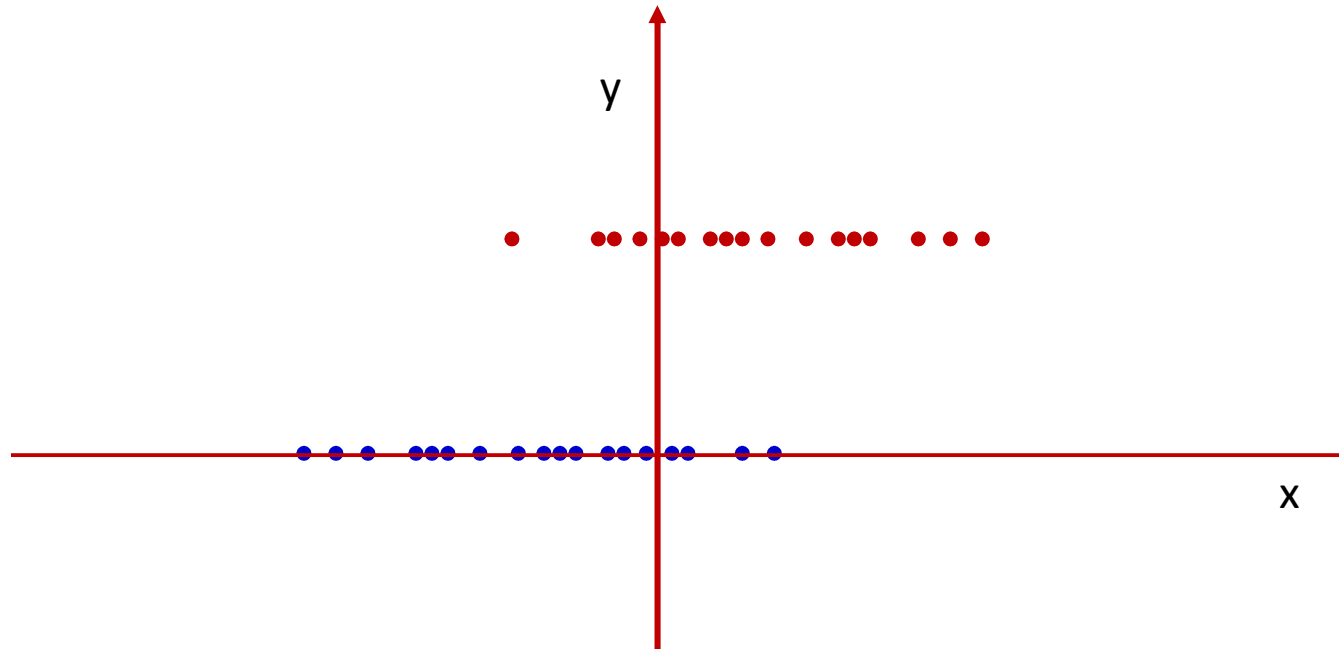

- One-dimensional example for visualization
  - All (red) dots at  $Y=1$  represent instances of class  $Y=1$
  - All (blue) dots at  $Y=0$  are from class  $Y=0$
  - The data are not linearly separable
    - In this 1-D example, a linear separator is a threshold
    - No threshold will cleanly separate red and blue dots

# Undesired Function

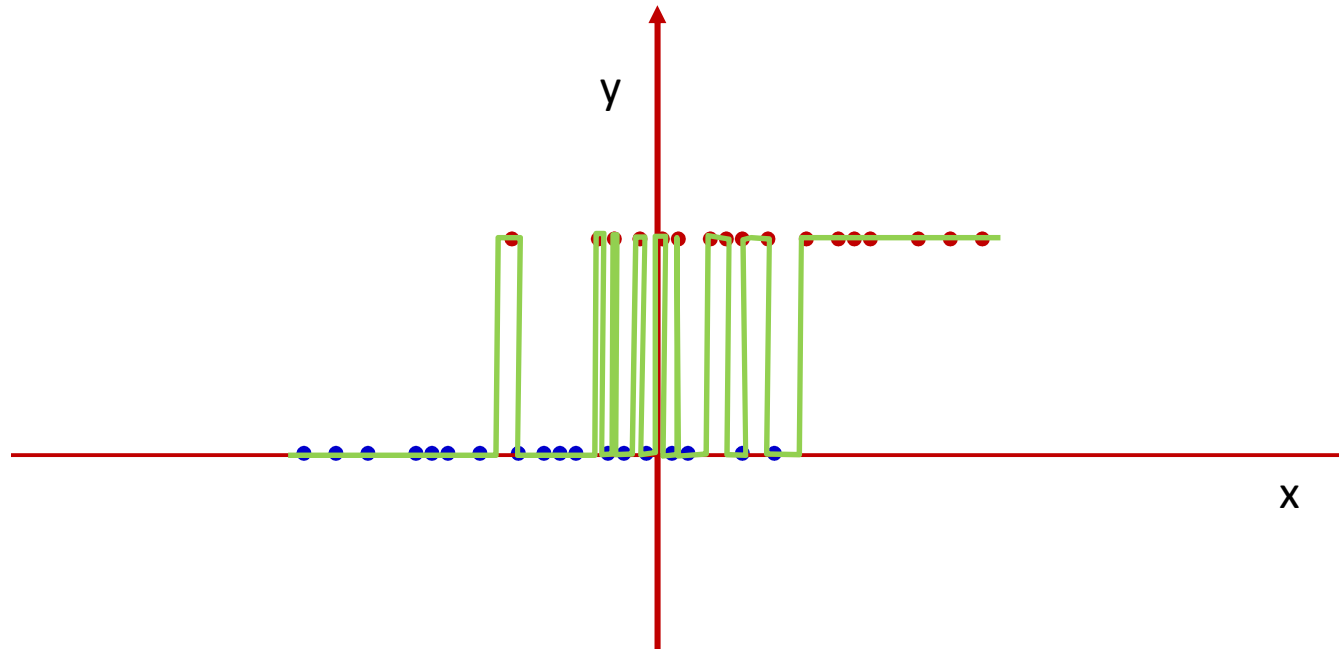

- One-dimensional example for visualization
  - All (red) dots at  $Y=1$  represent instances of class  $Y=1$
  - All (blue) dots at  $Y=0$  are from class  $Y=0$
  - The data are not linearly separable
    - In this 1-D example, a linear separator is a threshold
    - No threshold will cleanly separate red and blue dots

# What if?

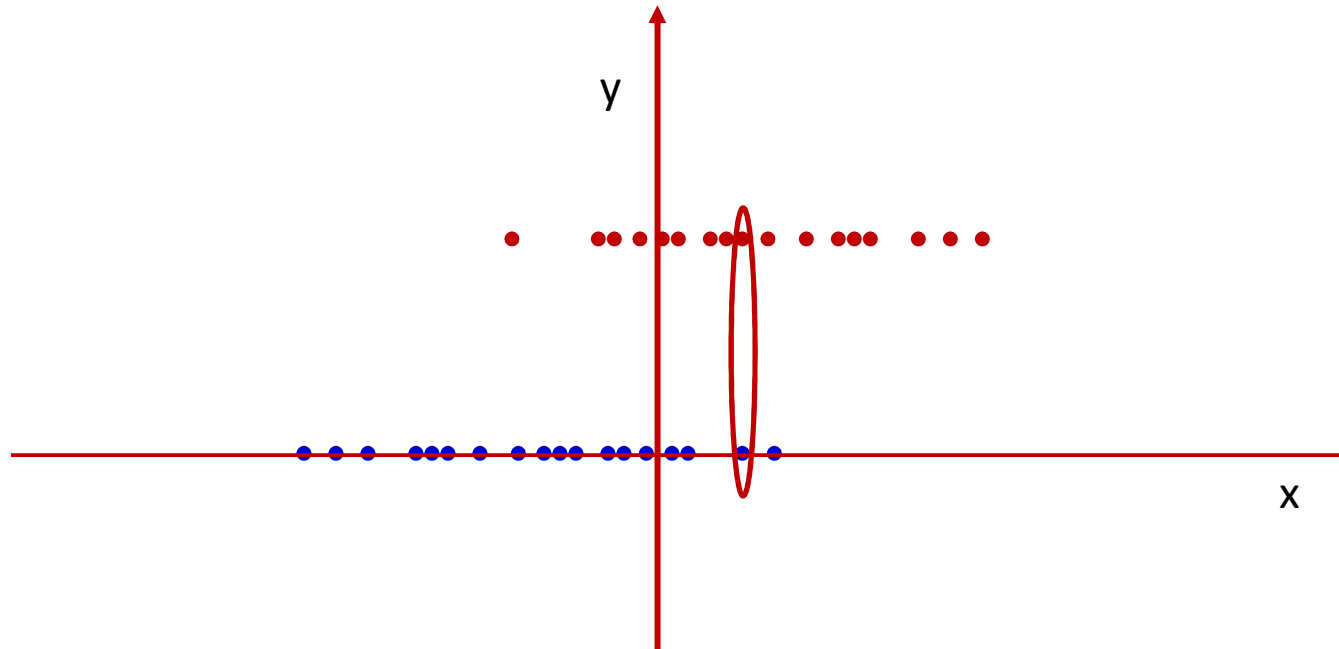

- One-dimensional example for visualization
  - All (red) dots at  $Y=1$  represent instances of class  $Y=1$
  - All (blue) dots at  $Y=0$  are from class  $Y=0$
  - The data are not linearly separable
    - In this 1-D example, a linear separator is a threshold
    - No threshold will cleanly separate red and blue dots



# What if?

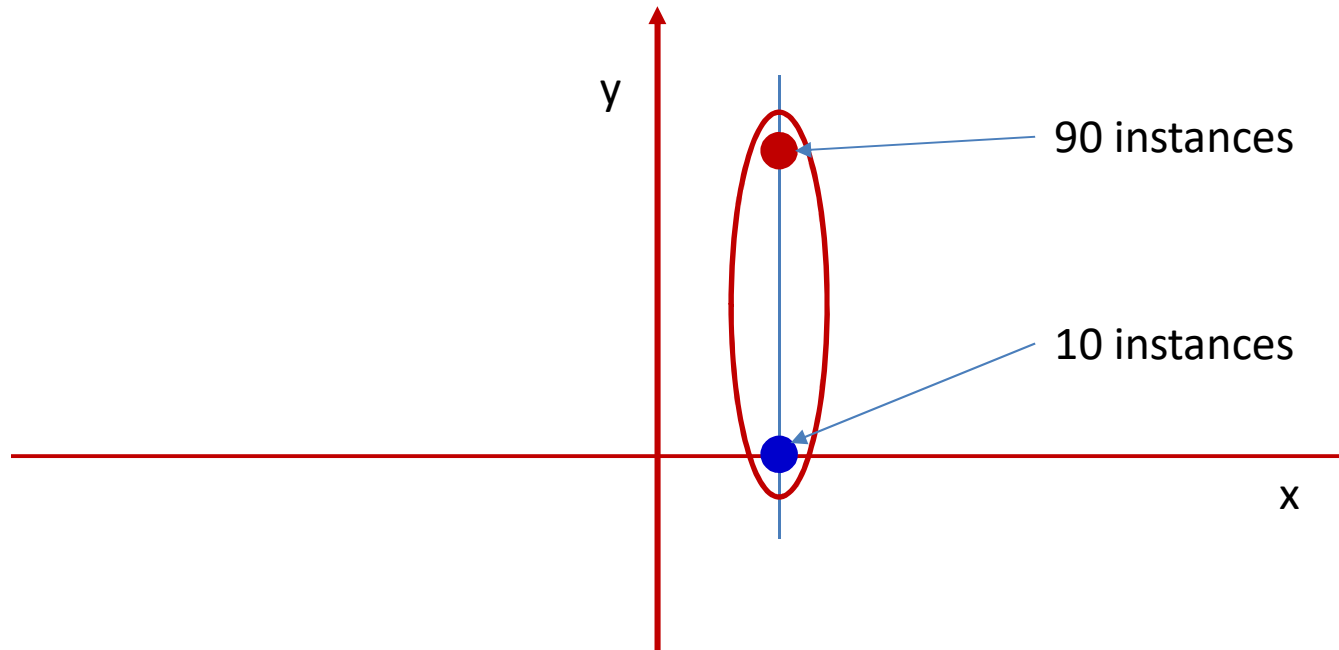

- What must the value of the function be at this  $x$ ?
  - 1 because red dominates?
  - 0.9 : The average?

# What if?

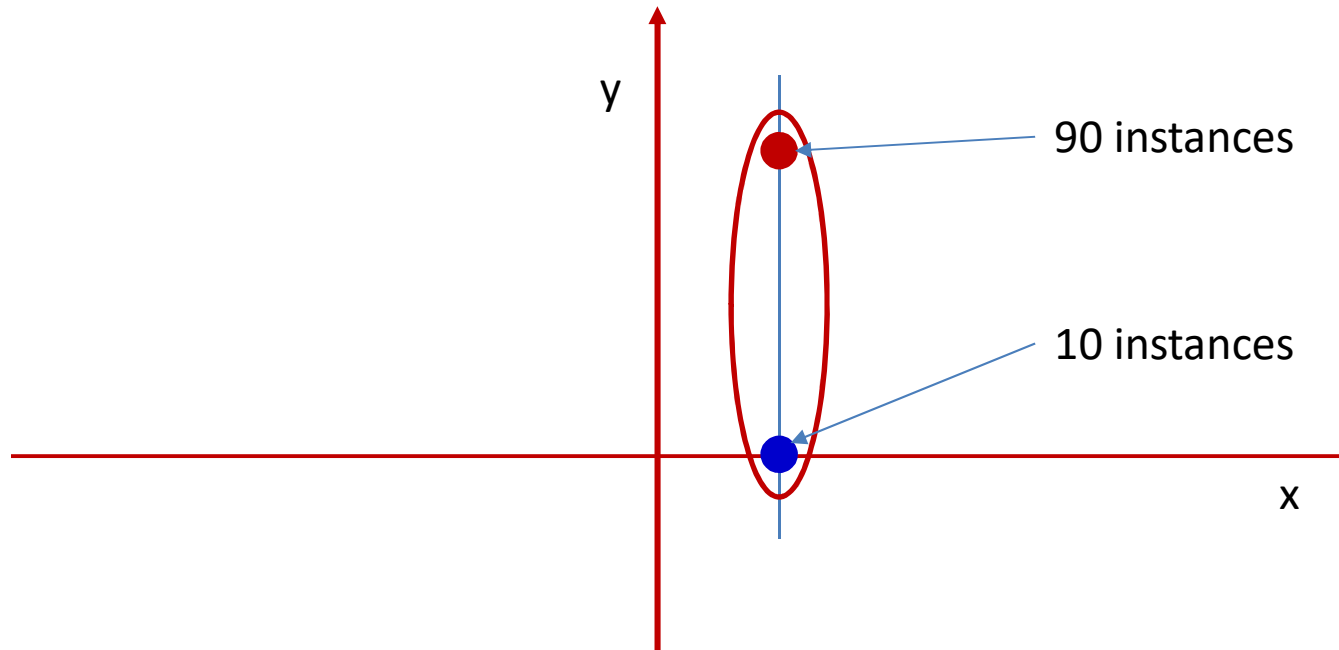

- What must the value of the function be at this  $X$ ?

- 1 because red dominates?
- 0.9 : The average?

Estimate:  $\approx P(1|X)$

Potentially much more useful than a simple 1/0 decision  
Also, potentially more realistic

# What if?

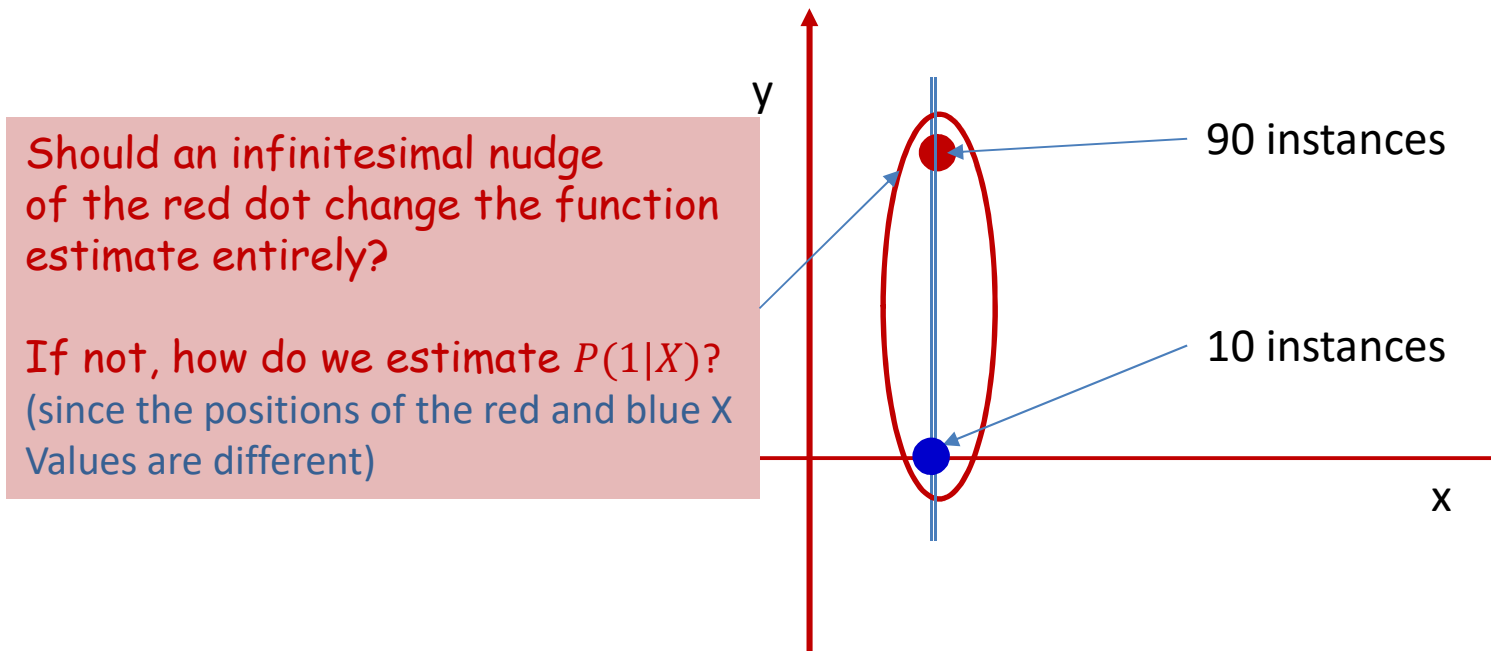

- What must the value of the function be at this X?

- 1 because red dominates?
- 0.9 : The average?

Estimate:  $\approx P(1|X)$

Potentially much more useful than a simple 1/0 decision  
Also, potentially more realistic

# The *probability* of $y=1$

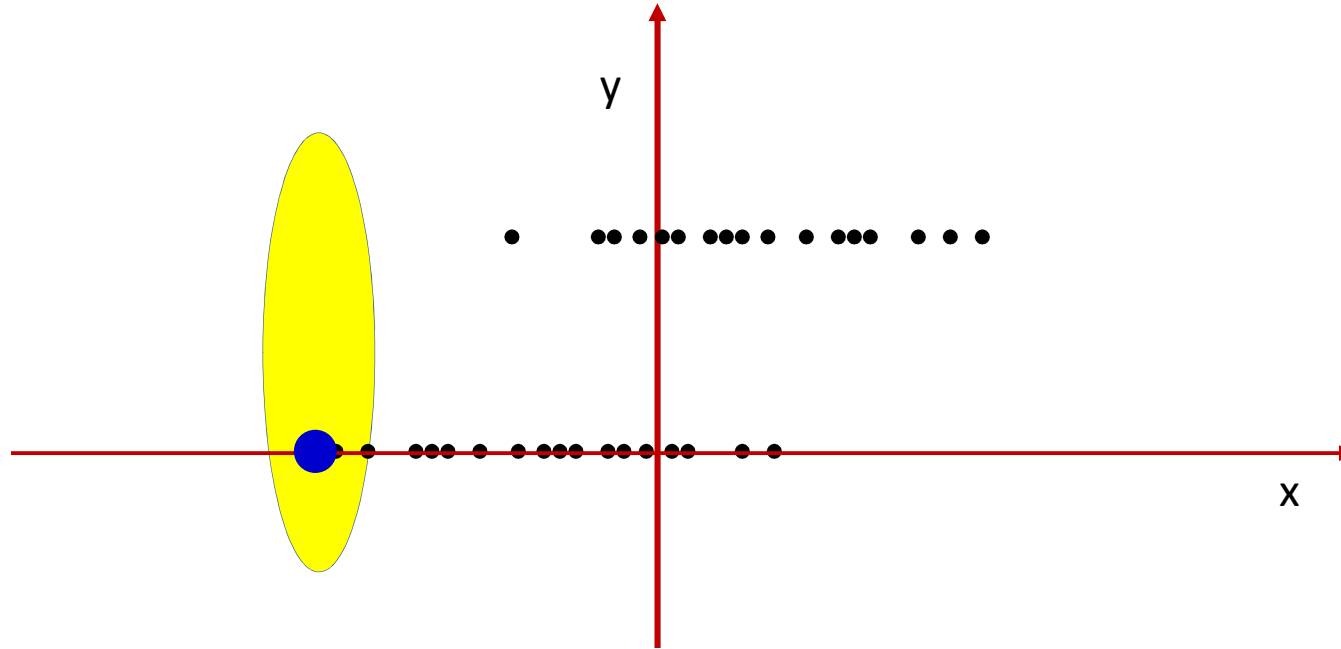

- Consider this differently: at each point look at a small window around that point
- Plot the average value within the window
  - This is an approximation of the *probability* of  $Y=1$  at that point

# The *probability* of $y=1$

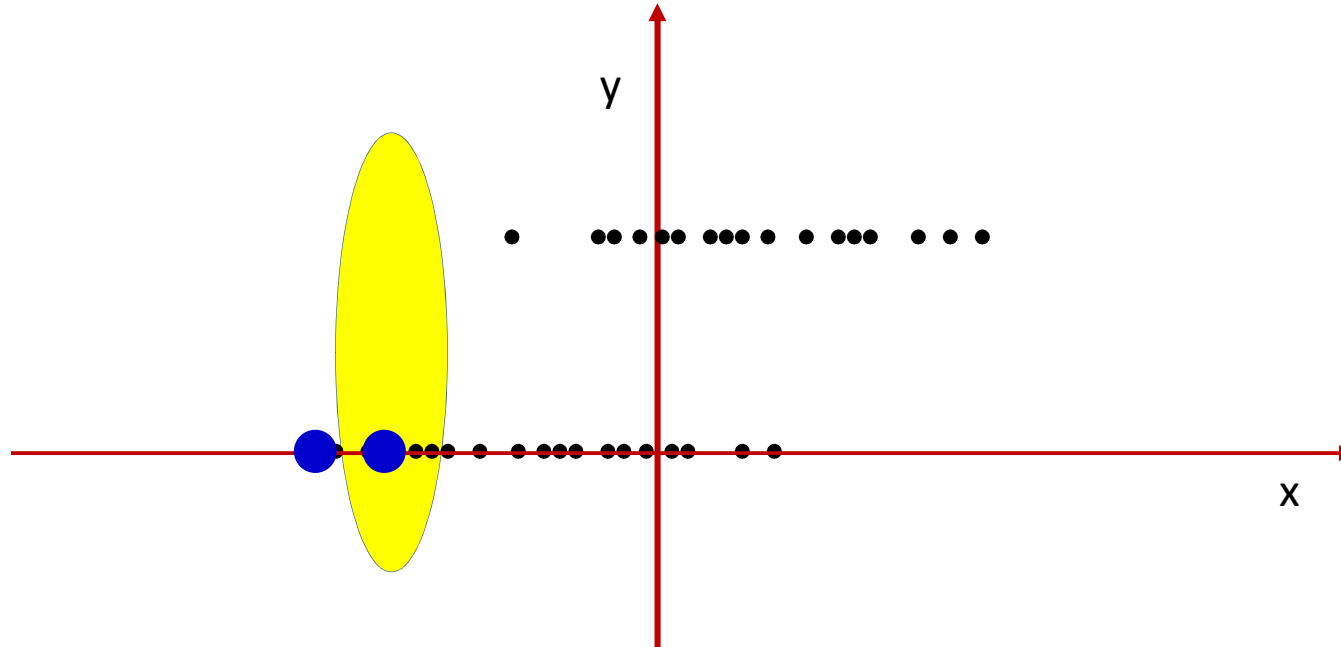

- Consider this differently: at each point look at a small window around that point
- Plot the average value within the window
  - This is an approximation of the *probability* of 1 at that point

# The *probability* of $y=1$

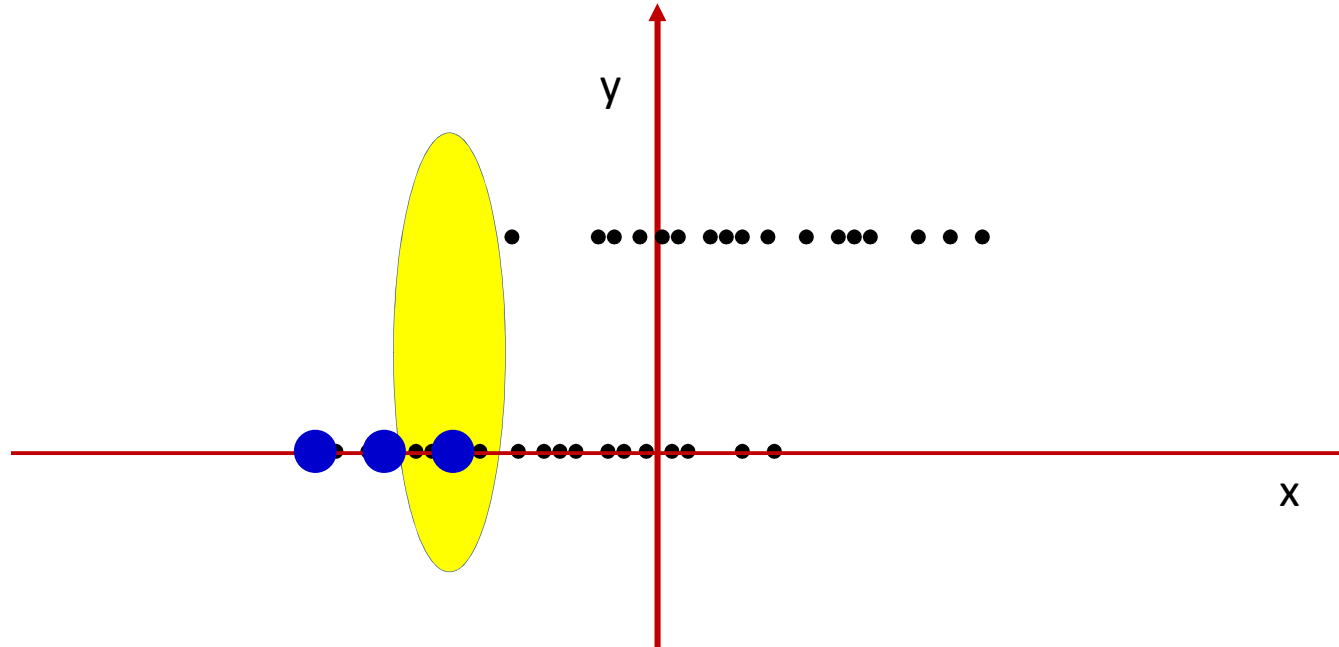

- Consider this differently: at each point look at a small window around that point
- Plot the average value within the window
  - This is an approximation of the *probability* of 1 at that point

# The *probability* of $y=1$

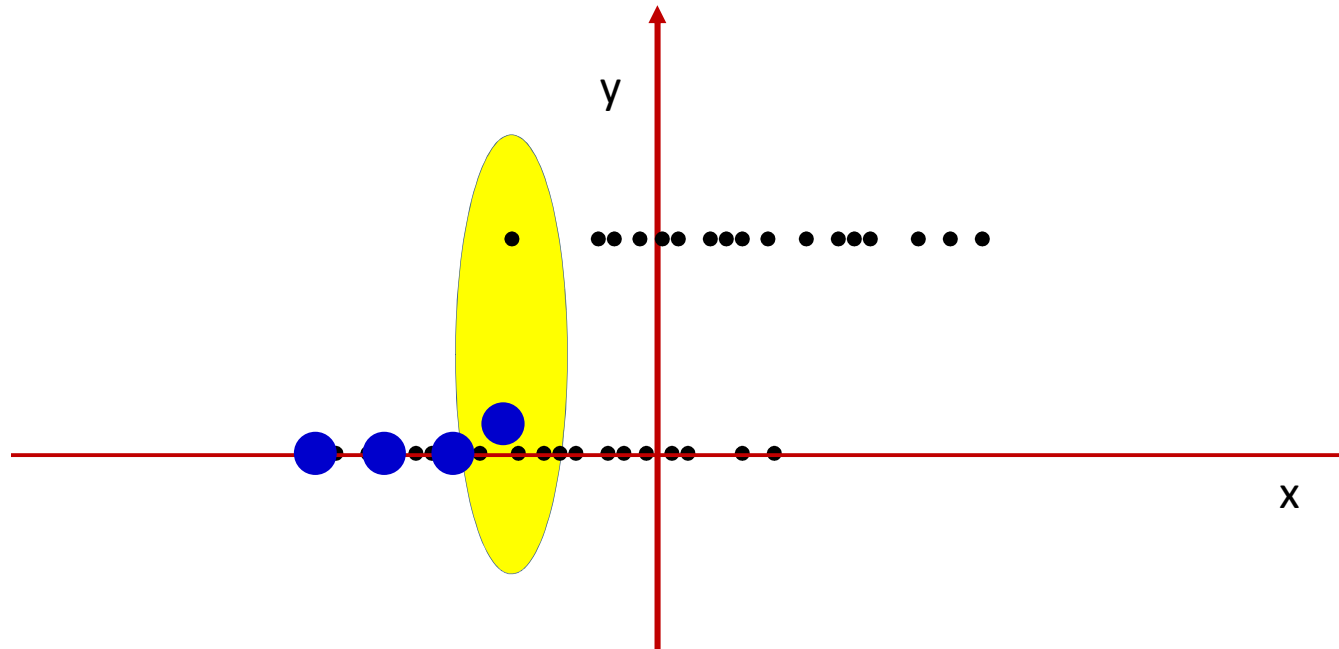

- Consider this differently: at each point look at a small window around that point
- Plot the average value within the window
  - This is an approximation of the *probability* of 1 at that point

# The *probability* of $y=1$

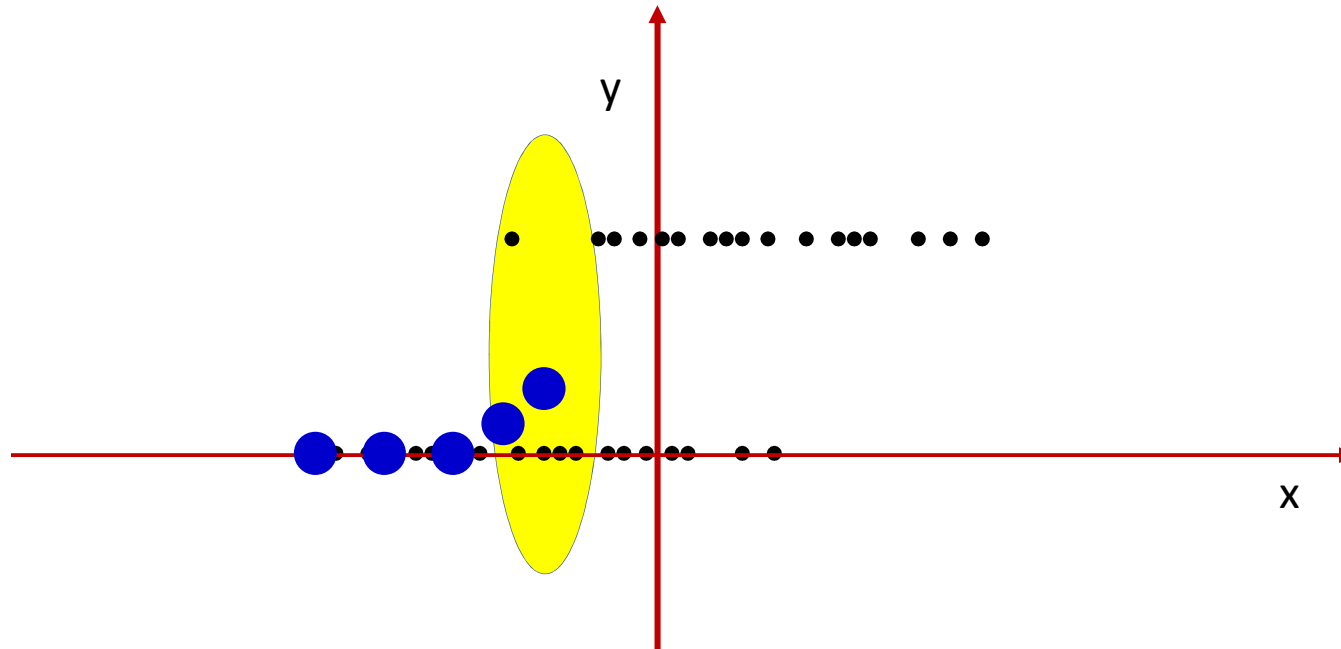

- Consider this differently: at each point look at a small window around that point
- Plot the average value within the window
  - This is an approximation of the *probability* of 1 at that point



# The *probability* of $y=1$

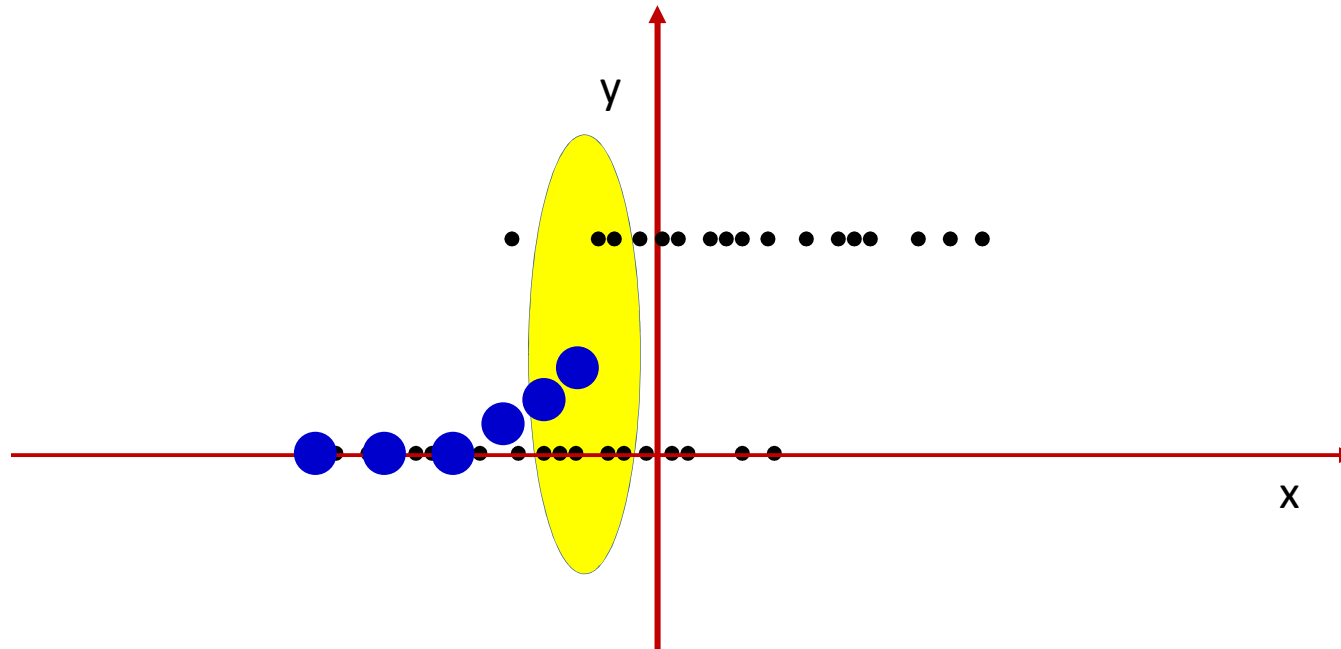

- Consider this differently: at each point look at a small window around that point
- Plot the average value within the window
  - This is an approximation of the *probability* of 1 at that point

# The *probability* of $y=1$

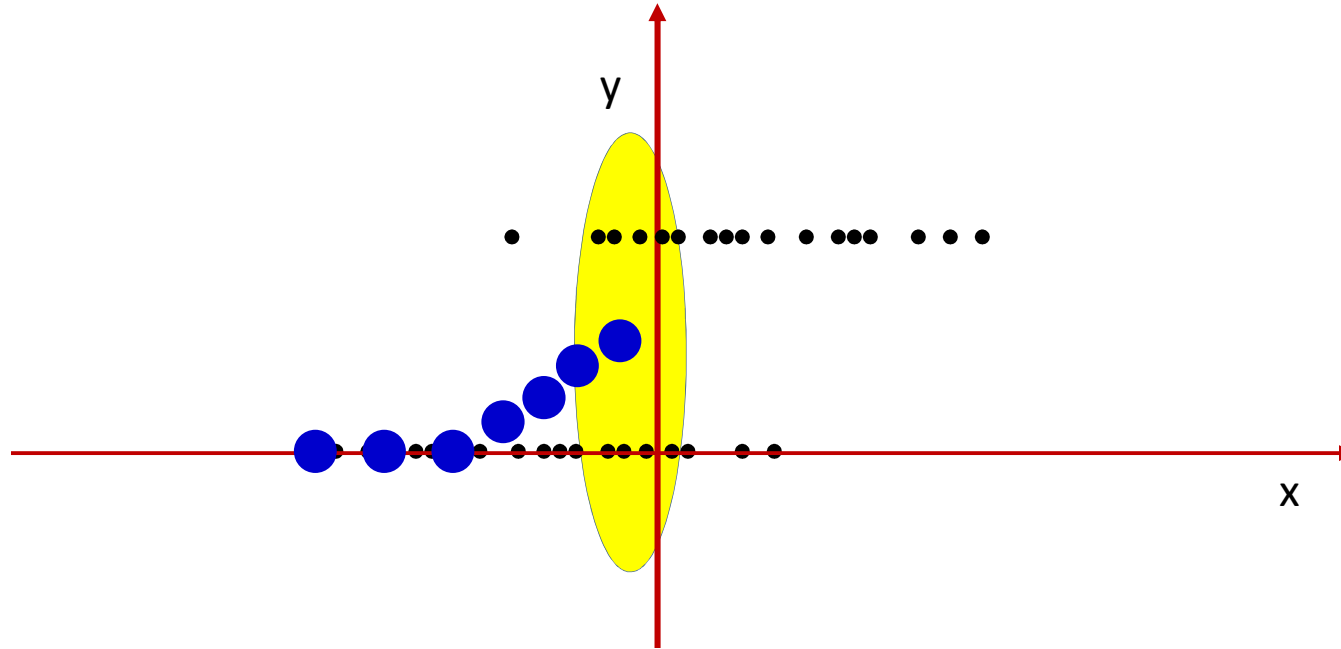

- Consider this differently: at each point look at a small window around that point
- Plot the average value within the window
  - This is an approximation of the *probability* of 1 at that point

# The *probability* of $y=1$

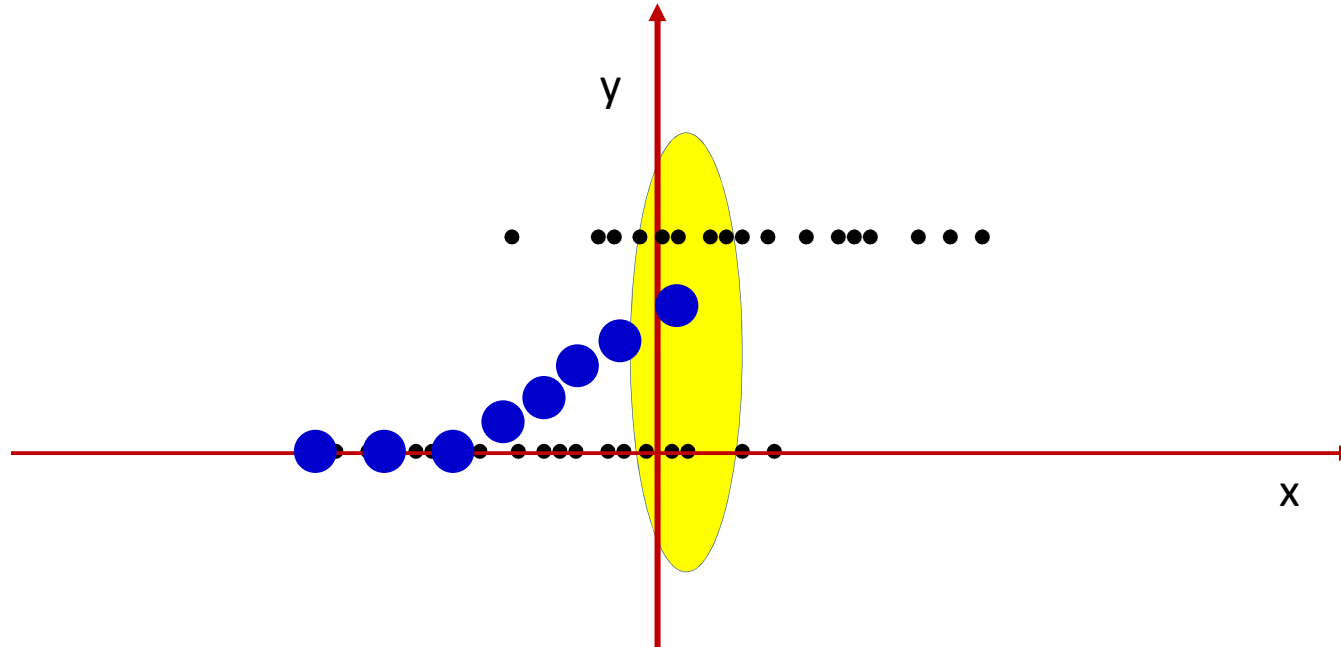

- Consider this differently: at each point look at a small window around that point
- Plot the average value within the window
  - This is an approximation of the *probability* of 1 at that point

# The *probability* of $y=1$

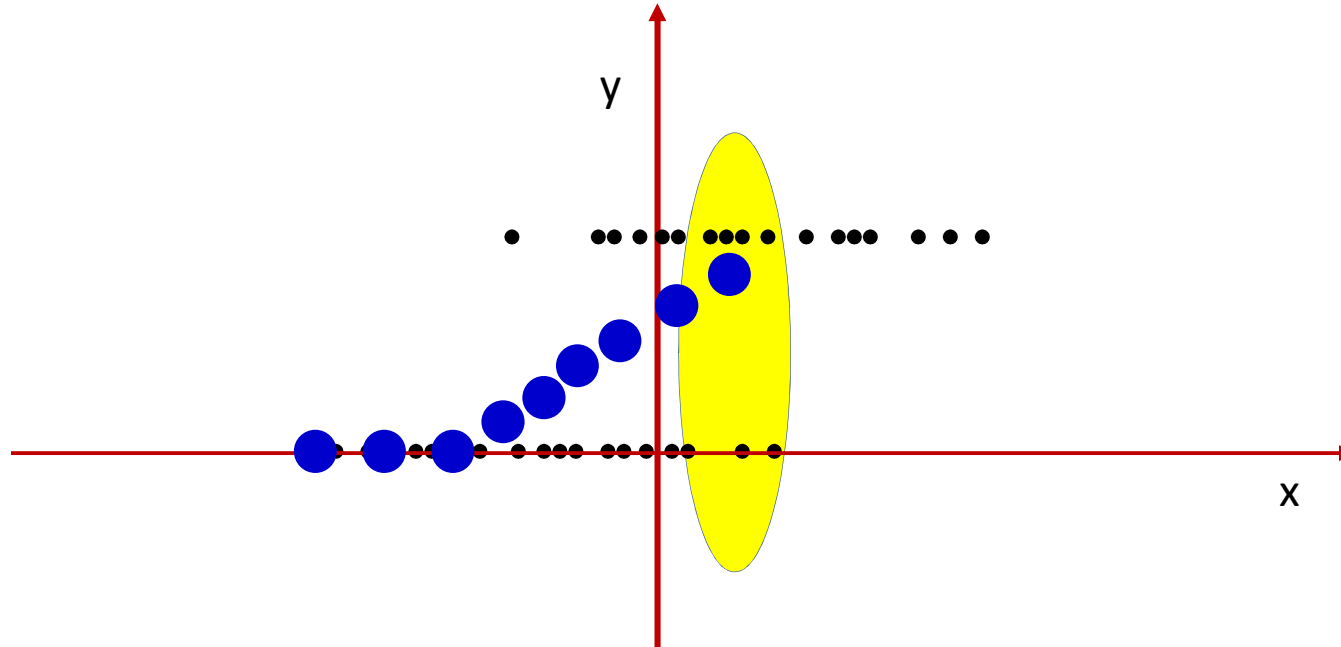

- Consider this differently: at each point look at a small window around that point
- Plot the average value within the window
  - This is an approximation of the *probability* of 1 at that point

# The *probability* of $y=1$

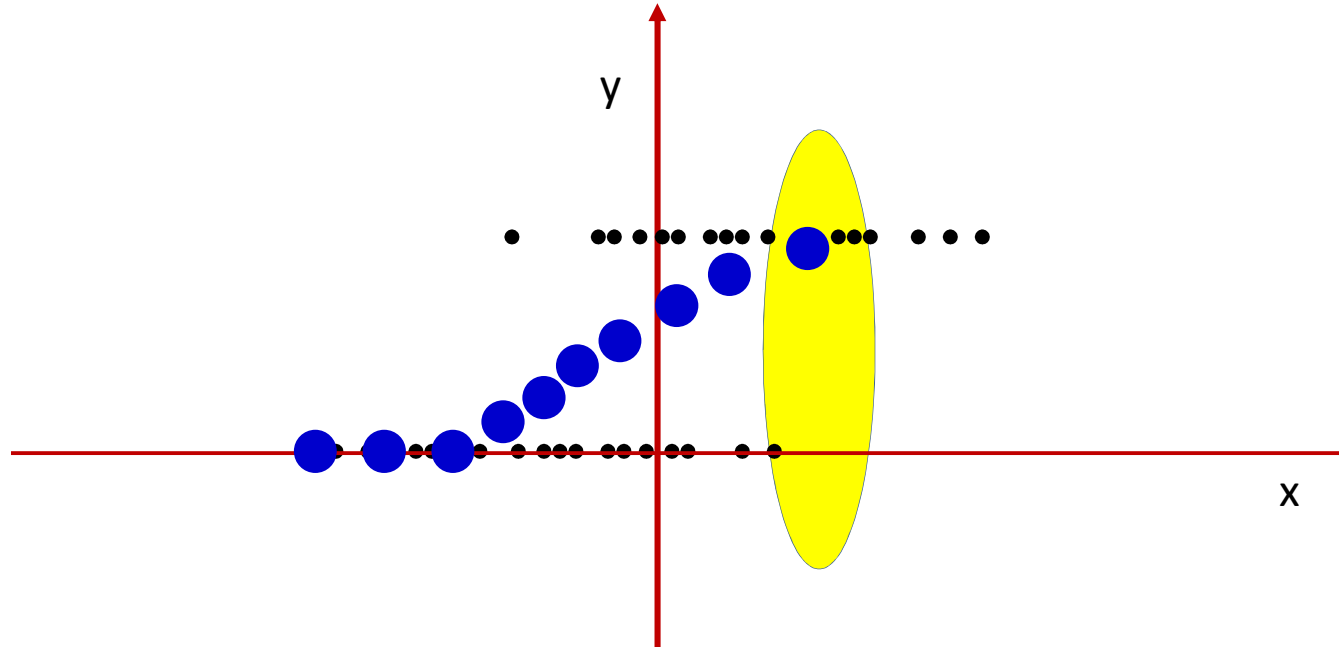

- Consider this differently: at each point look at a small window around that point
- Plot the average value within the window
  - This is an approximation of the *probability* of 1 at that point

# The *probability* of $y=1$

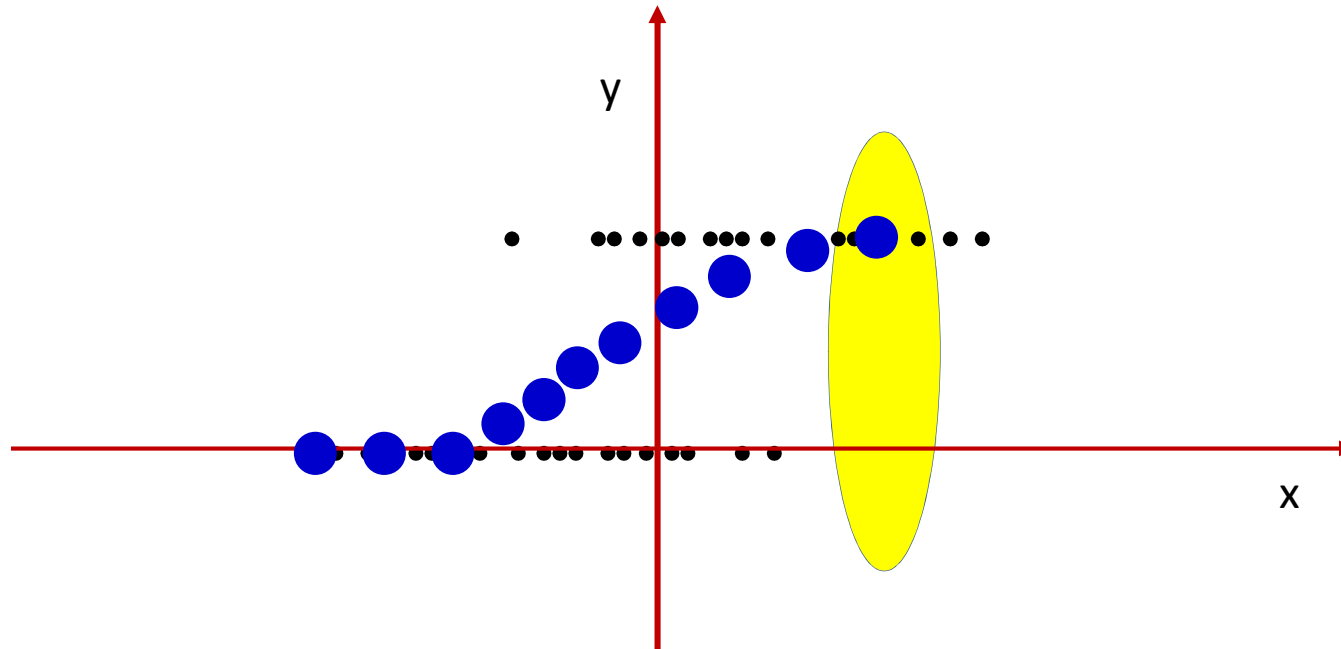

- Consider this differently: at each point look at a small window around that point
- Plot the average value within the window
  - This is an approximation of the *probability* of 1 at that point

# The *probability* of $y=1$

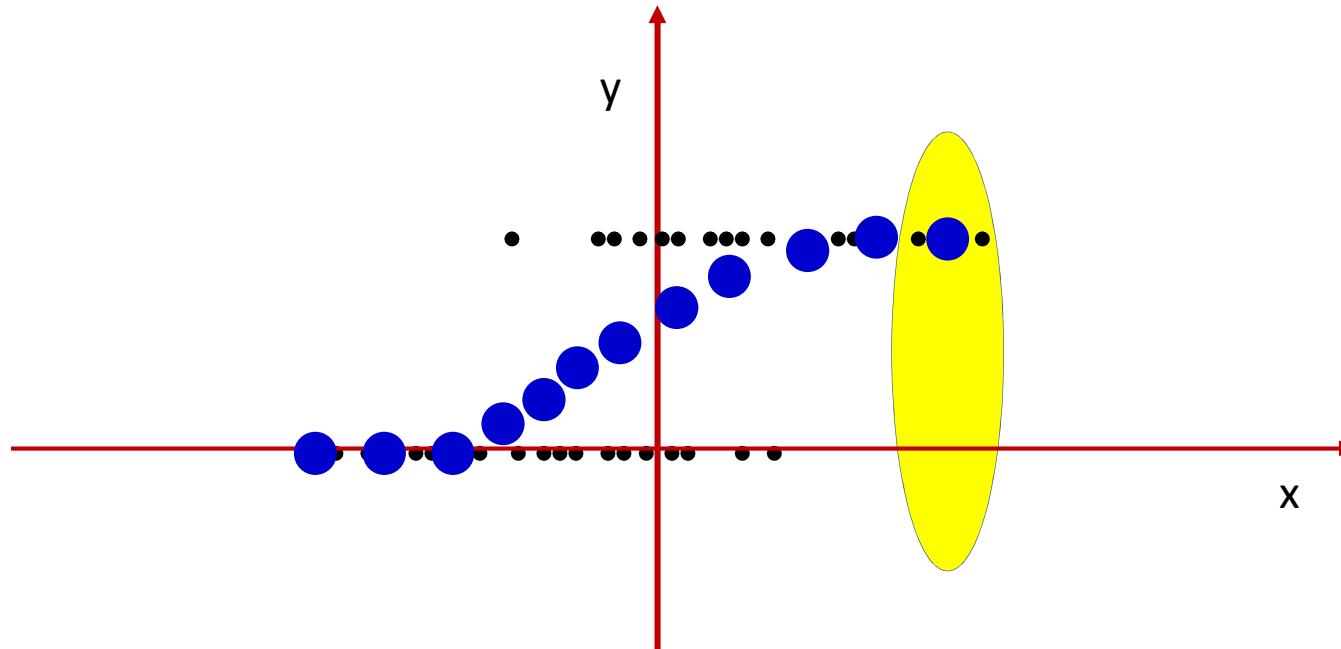

- Consider this differently: at each point look at a small window around that point
- Plot the average value within the window
  - This is an approximation of the *probability* of 1 at that point

# The *probability* of $y=1$

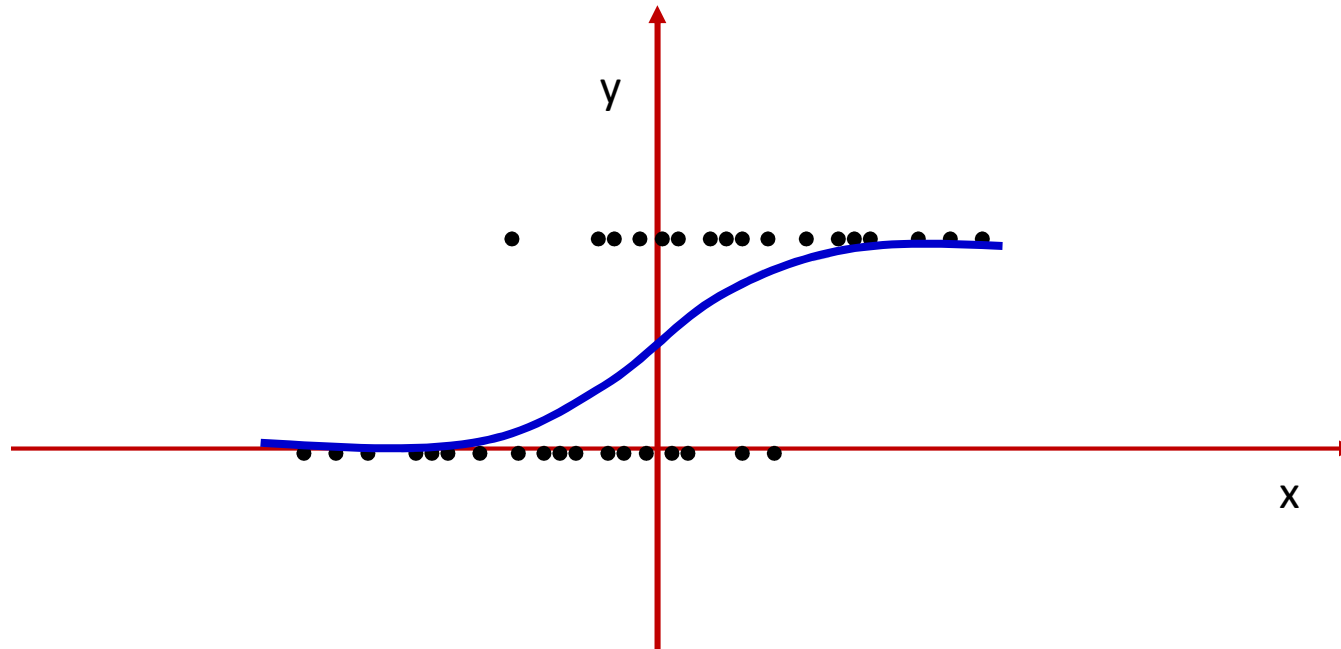

- Consider this differently: at each point look at a small window around that point
- Plot the average value within the window
  - This is an approximation of the *probability* of 1 at that point



# The logistic regression model

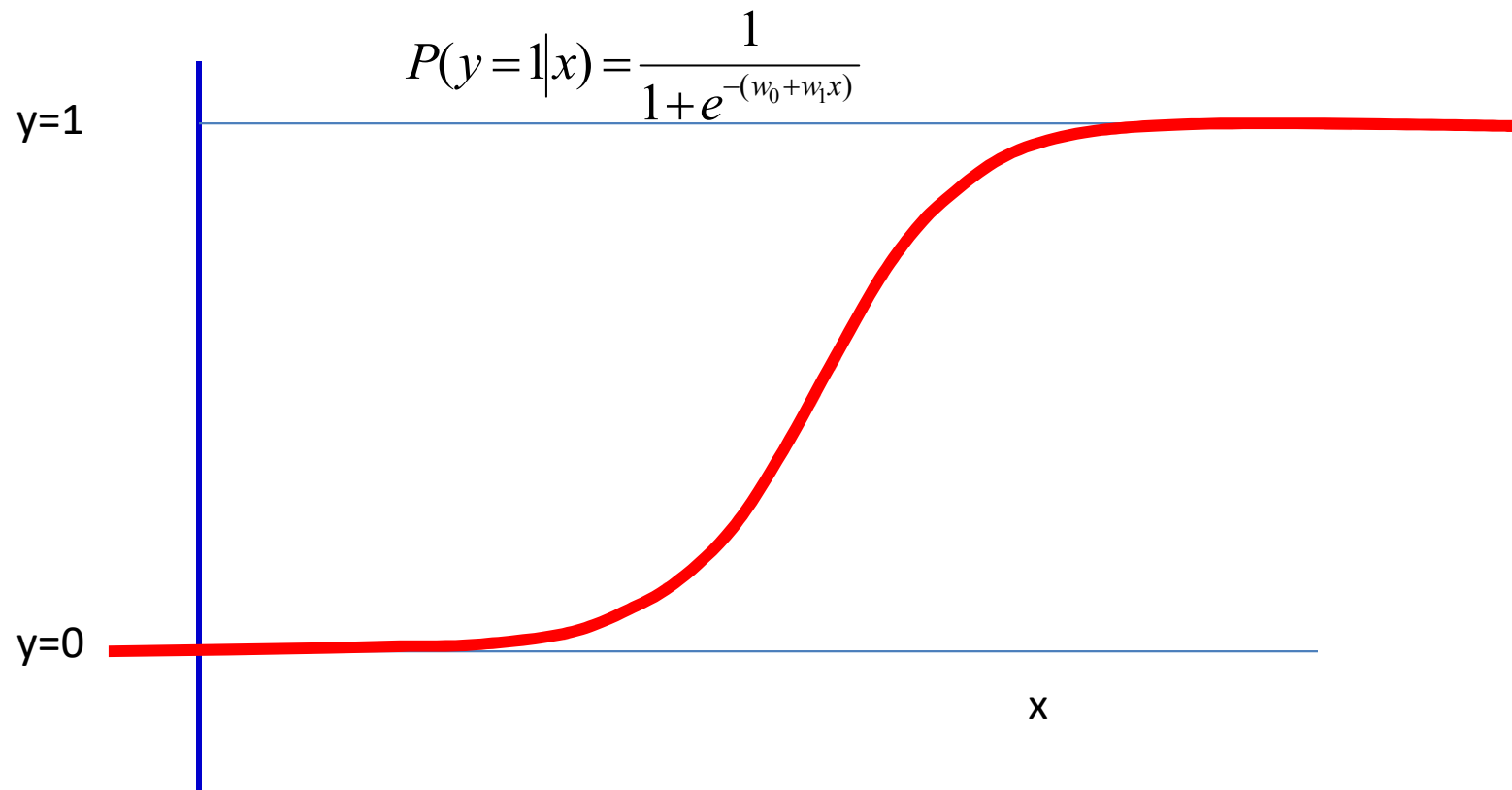

- Class 1 becomes increasingly probable going left to right
  - Very typical in many problems

# The logistic perceptron

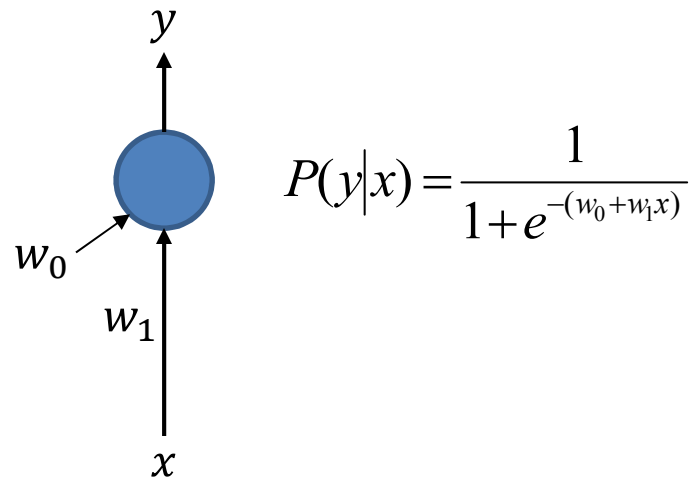

- A sigmoid perceptron with a single input models the *a posteriori* probability of the class given the input

# Non-linearly separable data

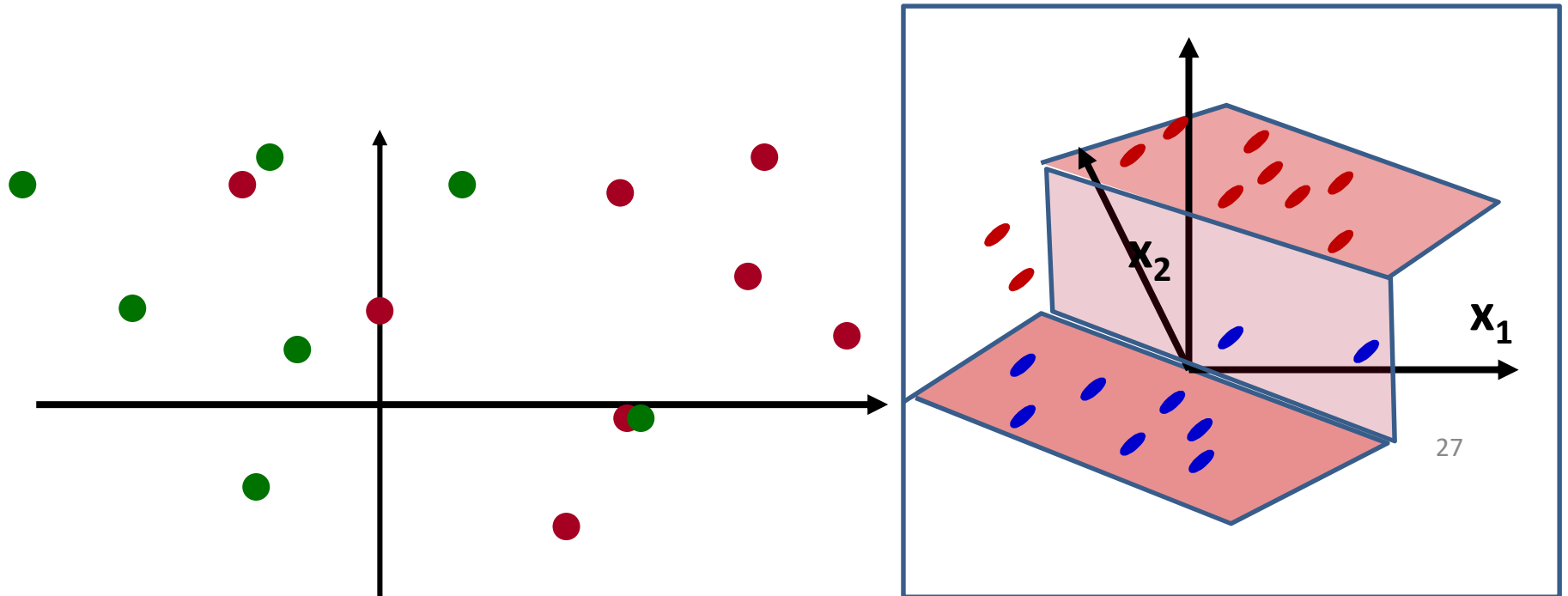

- Two-dimensional example
  - Blue dots (on the floor) on the “red” side
  - Red dots (suspended at  $Y=1$ ) on the “blue” side
  - No line will cleanly separate the two colors

# Logistic regression

$$P(Y = 1|X) = \frac{1}{1 + \exp(-(\sum_i w_i x_i + w_0))}$$

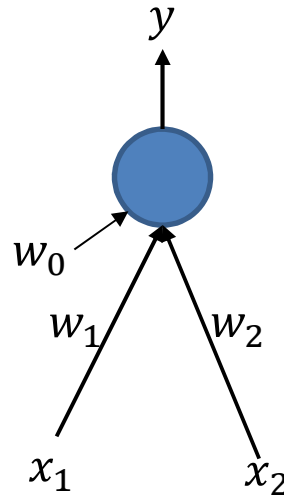
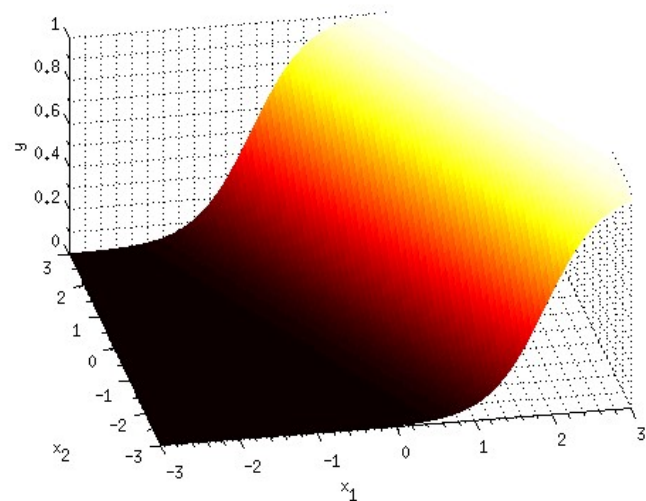

Decision:  $y > 0.5$ ?

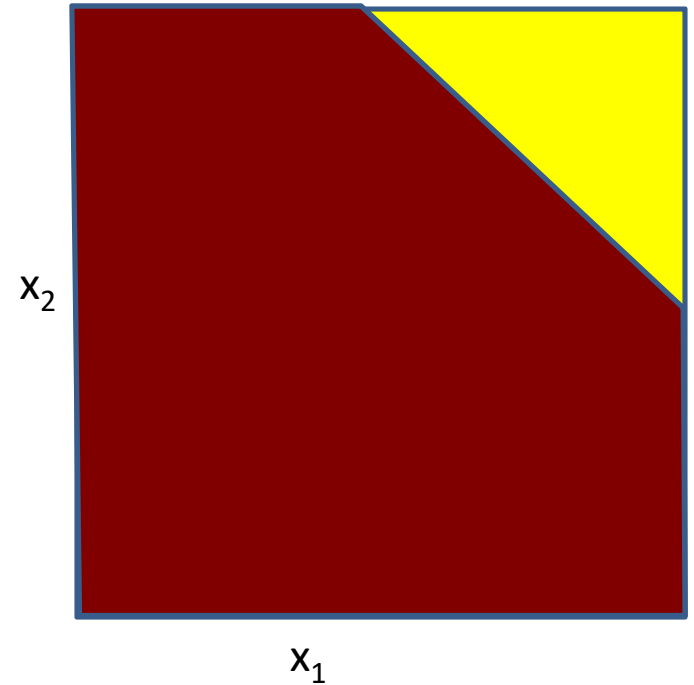

When  $X$  is a 2-D variable

- This is the perceptron with a sigmoid activation
  - It actually computes the *probability* that the input belongs to class 1
  - Decision boundaries may be obtained by comparing the probability to a threshold
    - These boundaries will be lines (hyperplanes in higher dimensions)
    - The sigmoid perceptron is a *linear classifier*

# Estimating the model

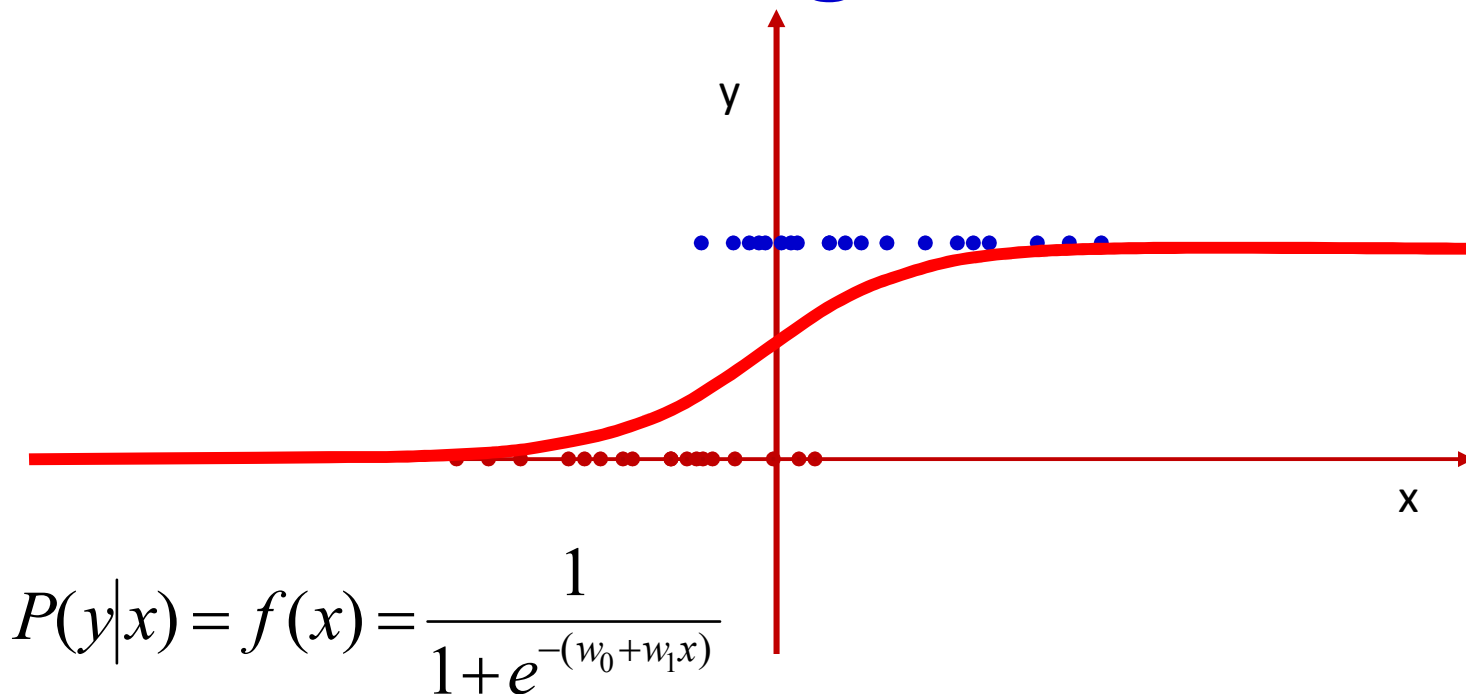

- Given the training data (many  $(x, y)$  pairs represented by the dots), estimate  $w_0$  and  $w_1$  for the curve

# Estimating the model

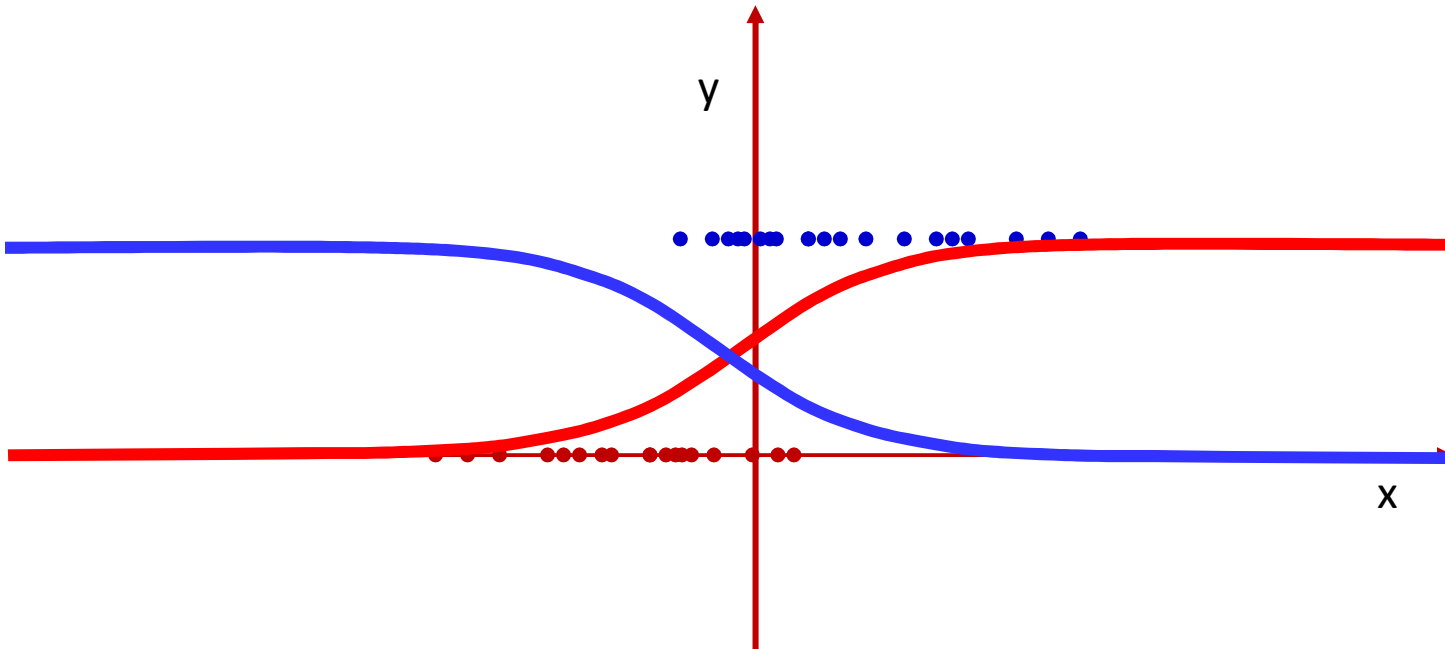

- Easier to represent using a  $y = +1/-1$  notation

$$P(y = 1|x) = \frac{1}{1 + e^{-(w_0 + w_1 x)}}$$

$$P(y = -1|x) = \frac{1}{1 + e^{(w_0 + w_1 x)}}$$

$$P(y|x) = \frac{1}{1 + e^{-y(w_0 + w_1 x)}}$$

# Estimating the model

- Given: Training data  
 $(X_1, y_1), (X_2, y_2), \dots, (X_N, y_N)$
- $X$ s are vectors,  $y$ s are binary (0/1) class values
- Total probability of data

$$\begin{aligned} P((X_1, y_1), (X_2, y_2), \dots, (X_N, y_N)) &= \prod_i P(X_i, y_i) \\ &= \prod_i P(y_i | X_i) P(X_i) = \prod_i \frac{1}{1 + e^{-y_i(w_0 + w^T X_i)}} P(X_i) \end{aligned}$$

# Estimating the model

- Likelihood

$$P(\text{Training data}) = \prod_i \frac{1}{1 + e^{-y_i(w_0 + w^T X_i)}} P(X_i)$$

- Log likelihood

$$\log P(\text{Training data}) = \sum_i \log P(X_i) - \sum_i \log \left( 1 + e^{-y_i(w_0 + w^T X_i)} \right)$$



# Maximum Likelihood Estimate

$$\hat{w}_0, \hat{w}_1 = \underset{w_0, w_1}{\operatorname{argmax}} \log P(\text{Training data})$$

- Equals (note argmin rather than argmax)

$$\hat{w}_0, \hat{w}_1 = \underset{w_0, w}{\operatorname{argmin}} \sum_i \log \left( 1 + e^{-y_i(w_0 + w^T X_i)} \right)$$

- Identical to minimizing the KL divergence between the desired output  $y$  and actual output

$$\frac{1}{1 + e^{-(w_0 + w^T X_i)}}$$

- Cannot be solved directly, needs gradient descent

# So what about this one?

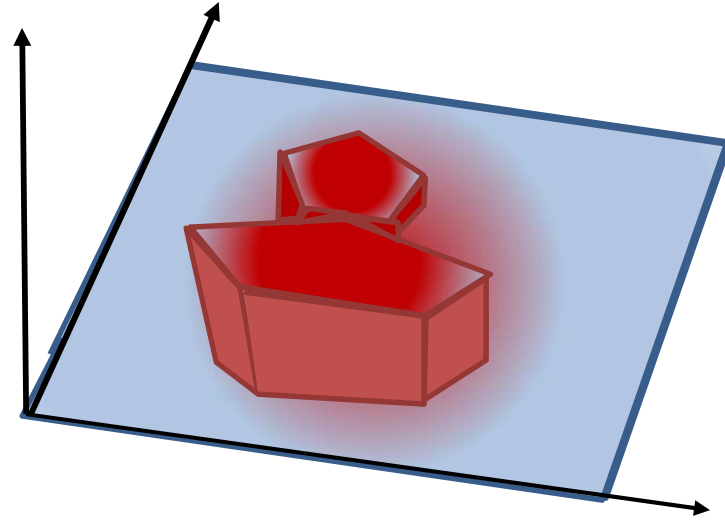
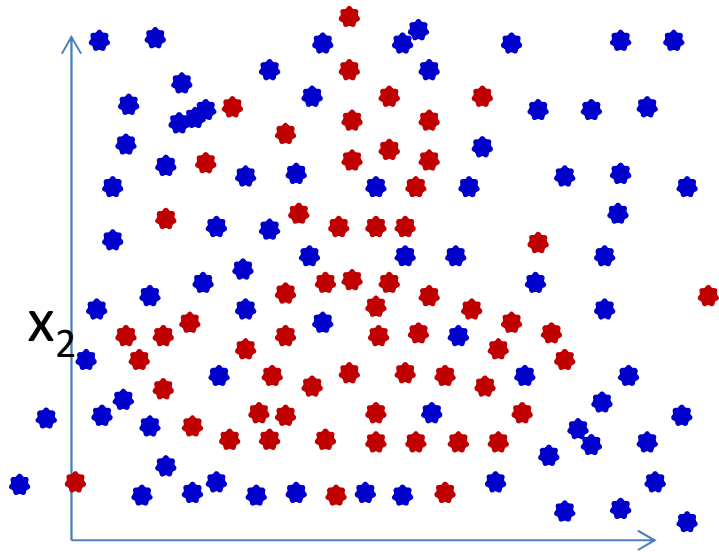

- Non-linear classifiers..

# First consider the separable case..

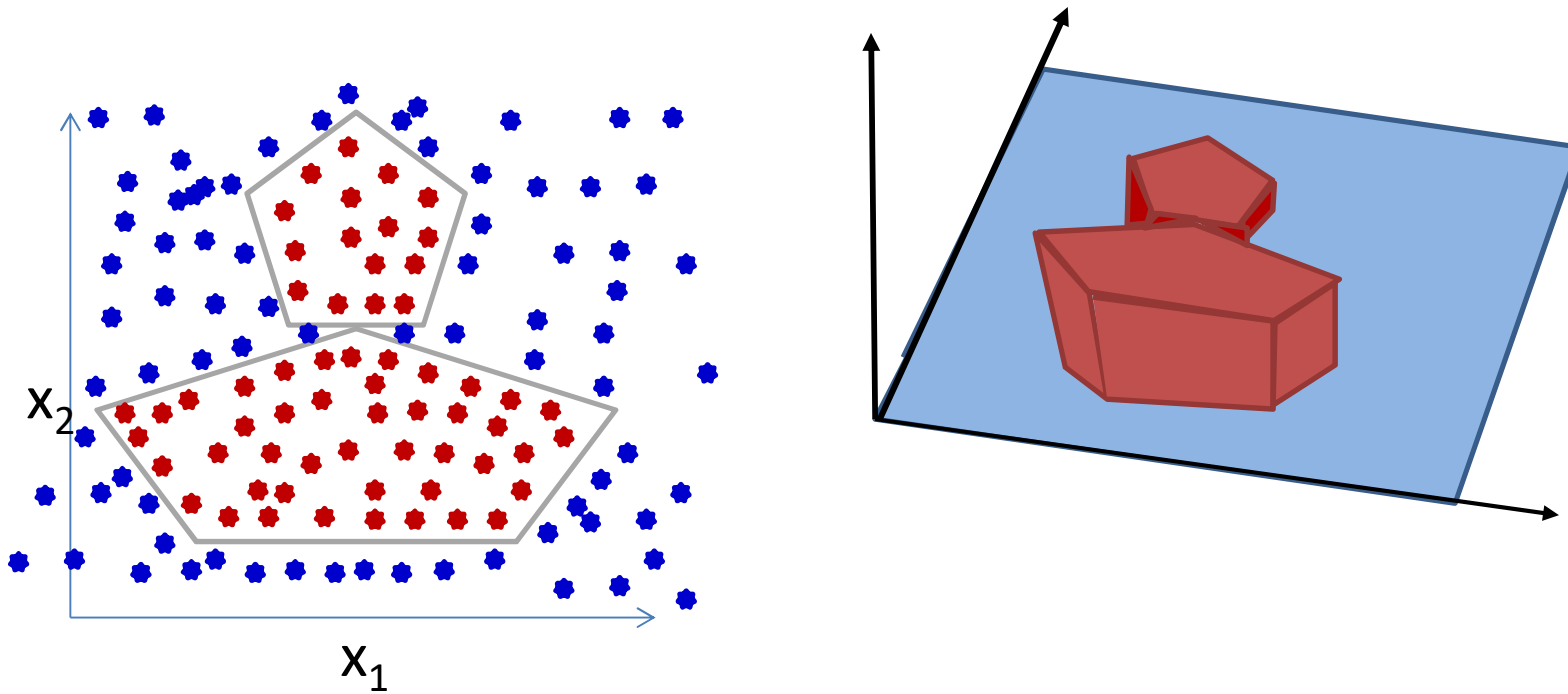

- When the net must learn to classify..

# First consider the separable case..

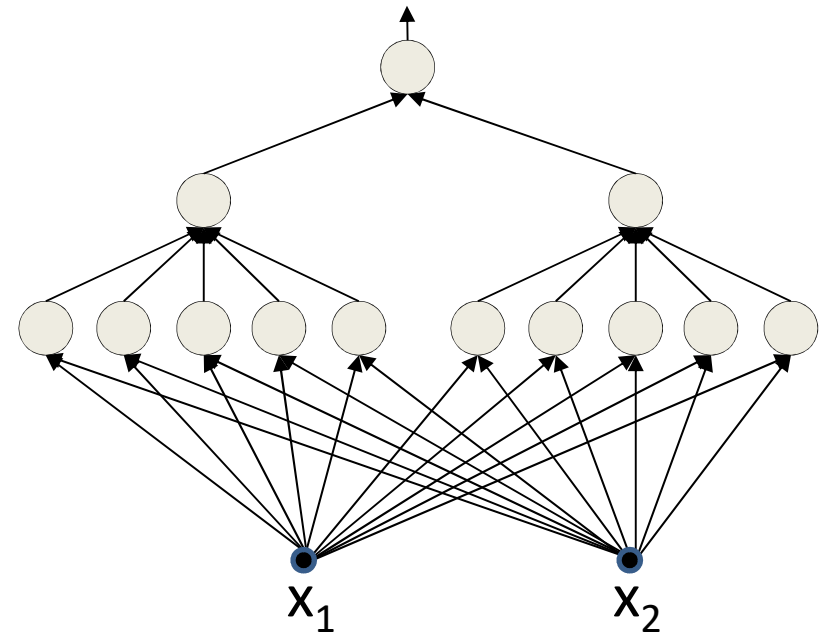
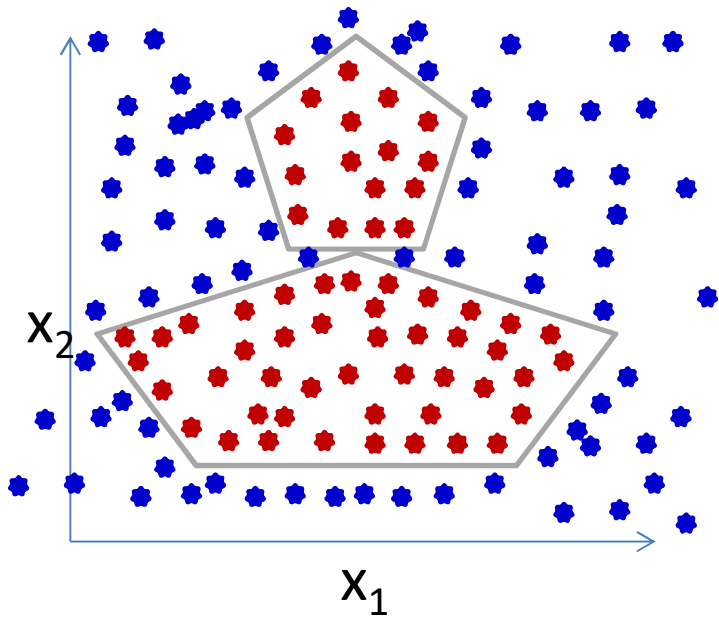

- For a “sufficient” net

# First consider the separable case..

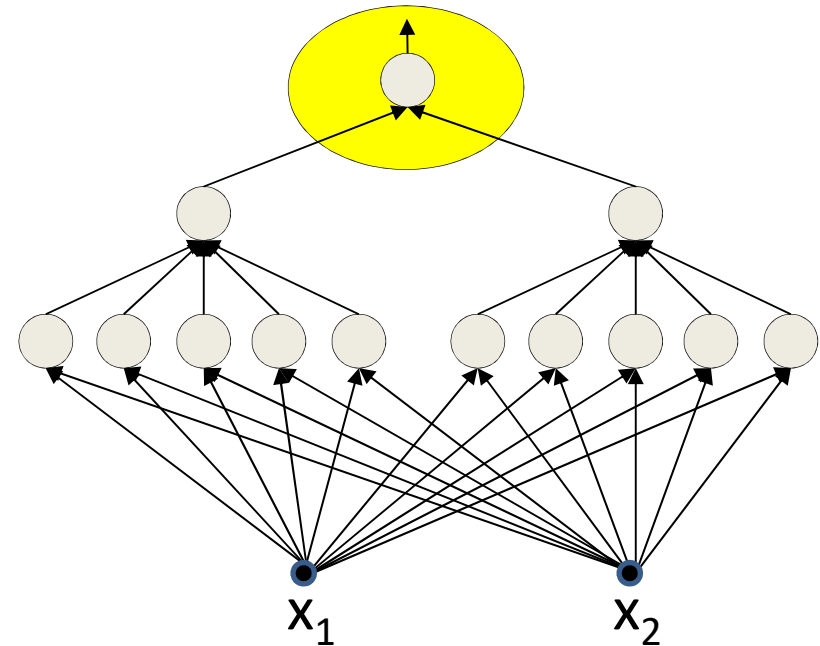
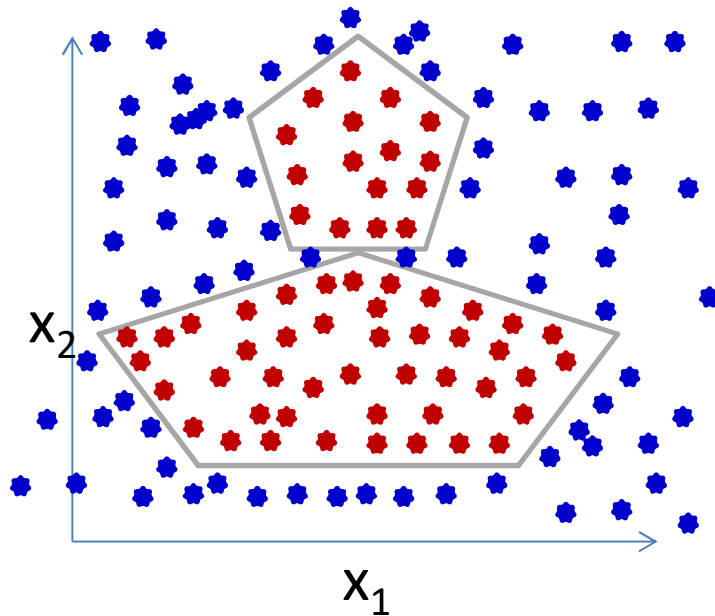

- For a “sufficient” net
- This final perceptron is a linear classifier

# First consider the separable case..

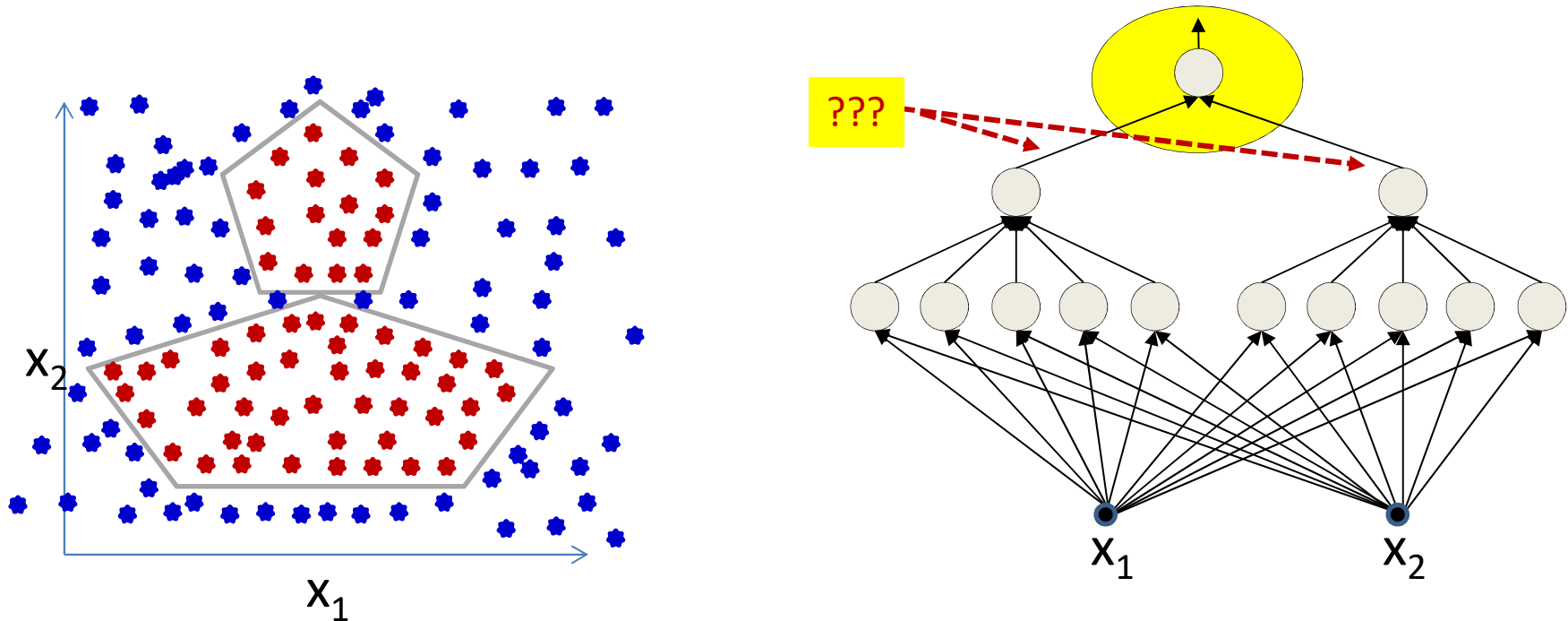

- For a “sufficient” net
- This final perceptron is a linear classifier over the output of the penultimate layer

# First consider the separable case..

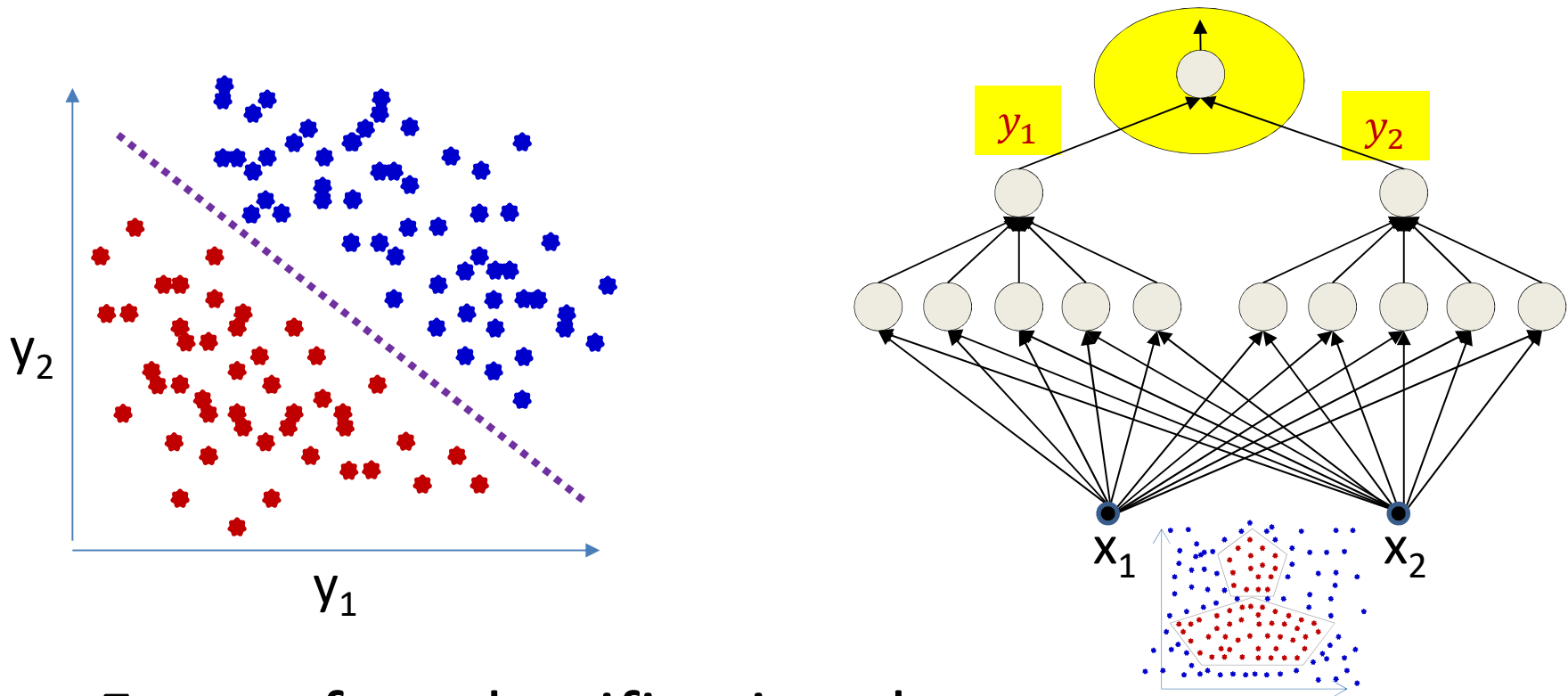

- For perfect classification the output of the penultimate layer must be linearly separable

# First consider the separable case..

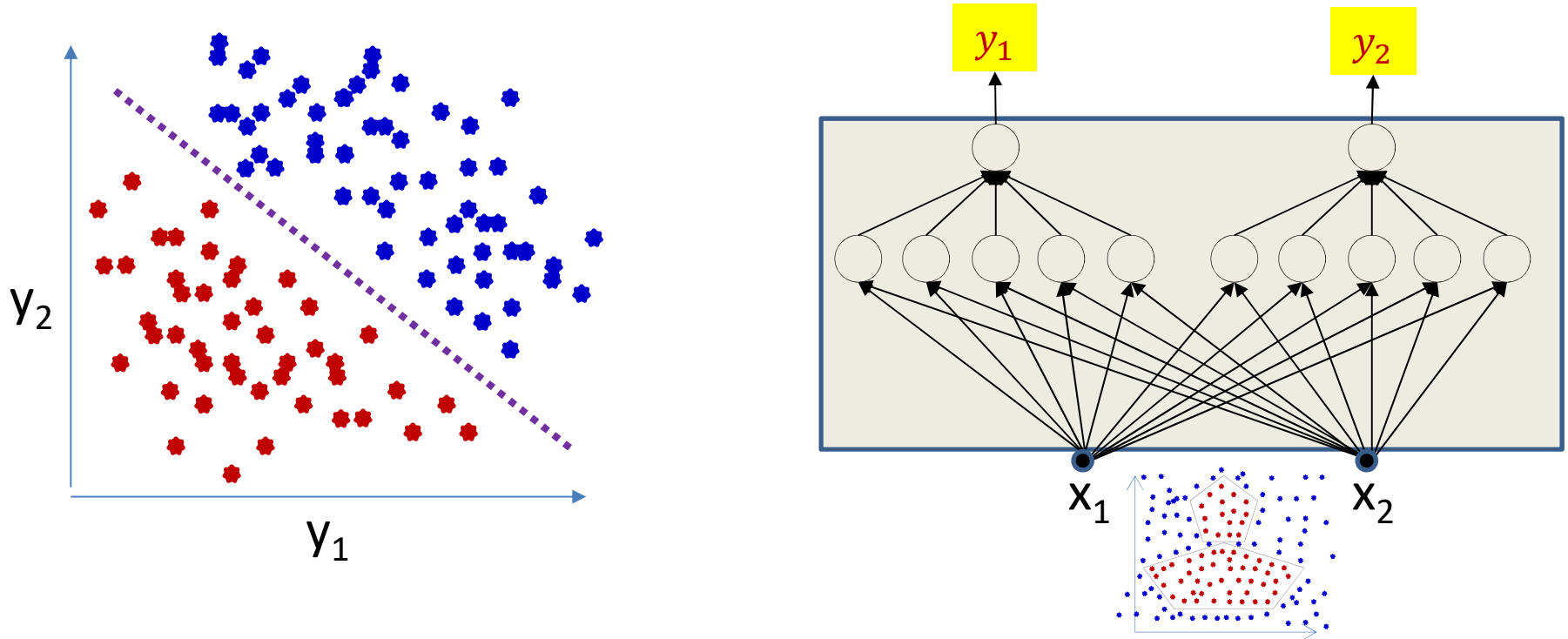

- The rest of the network may be viewed as a transformation that transforms data from non-linear classes to linearly separable features



# First consider the separable case..

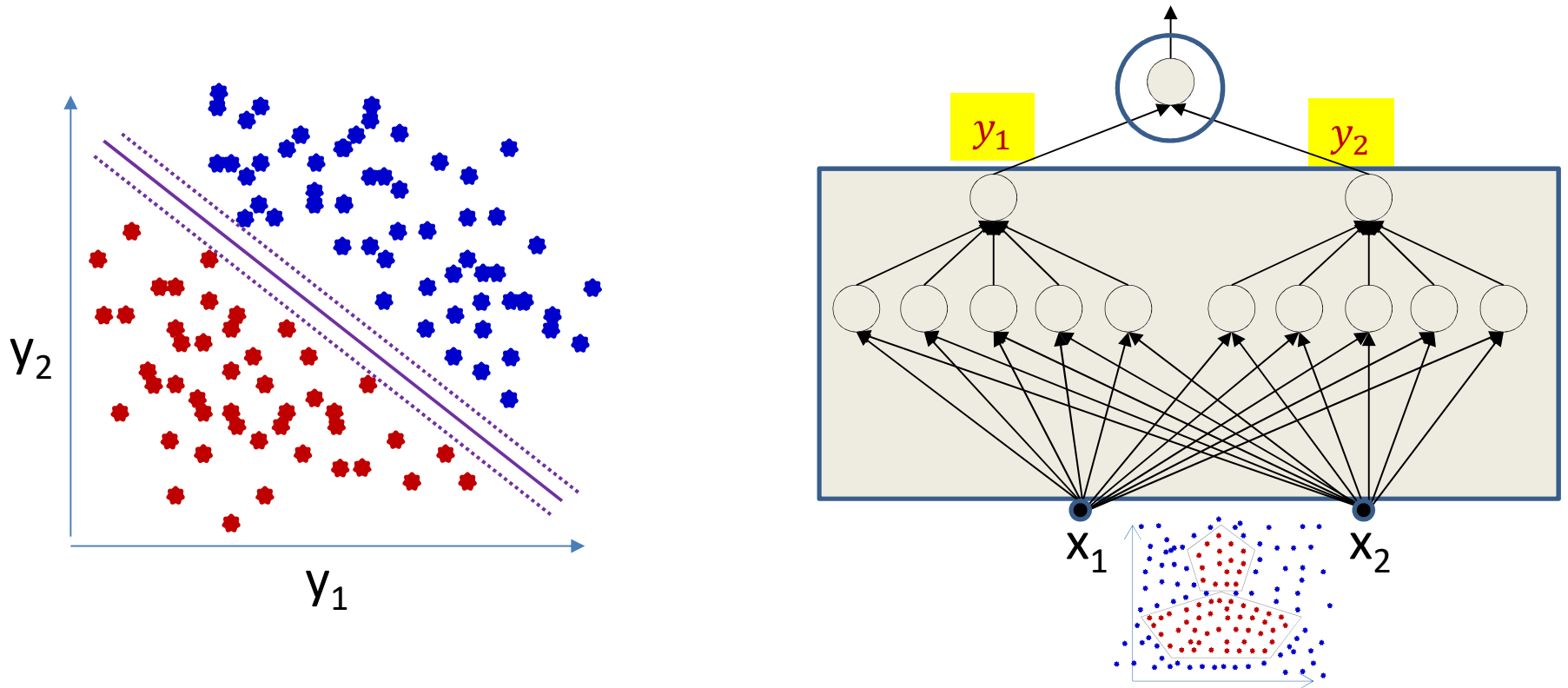

- The rest of the network may be viewed as a transformation that transforms data from non-linear classes to linearly separable features
  - We can now attach *any* linear classifier above it for perfect classification
  - Need not be a perceptron
  - In fact, for **binary** classifiers an SVM on top of the features may be more generalizable!

# First consider the separable case..

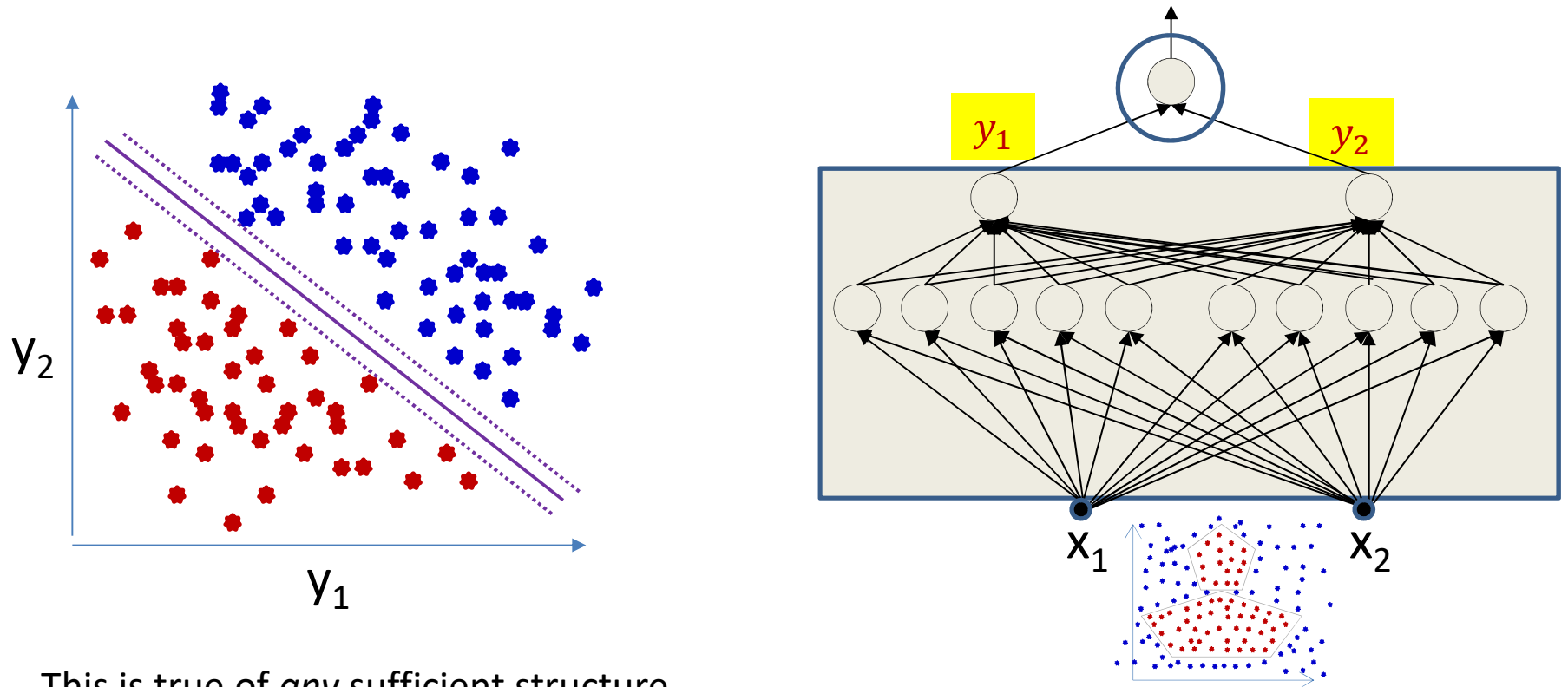

- This is true of *any* sufficient structure
  - Not just the optimal one
- For *insufficient* structures, the network may *attempt* to transform the inputs to linearly separable features
  - Will fail to separate
  - Still, for binary problems, using an SVM with slack may be more effective than a final perceptron!

# Mathematically..

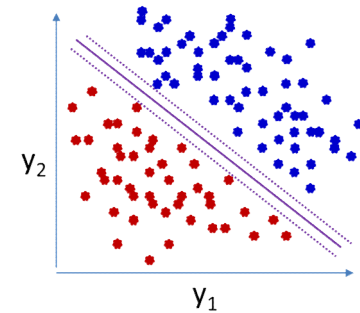
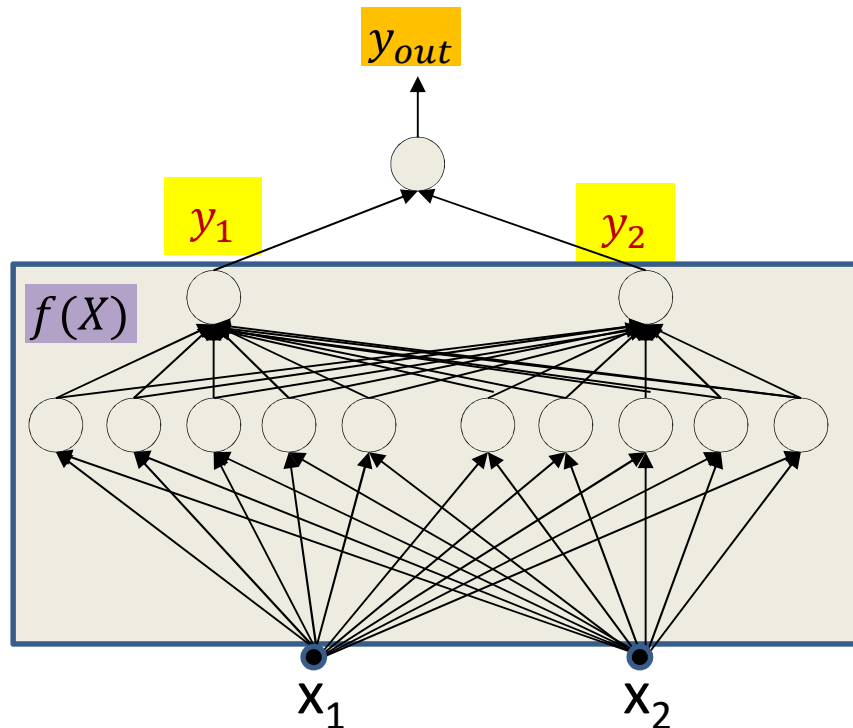

- $$y_{out} = \frac{1}{1 + \exp(b + W^T Y)} = \frac{1}{1 + \exp(b + W^T f(X))}$$
- The data are (almost) linearly separable in the space of  $Y$
- The network until the second-to-last layer is a non-linear function  $f(X)$  that converts the input space of  $X$  into the feature space  $Y$  where the classes are maximally linearly separable

# Story so far

- A classification MLP actually comprises two components
  - A “feature extraction network” that converts the inputs into linearly separable features
    - Or *nearly* linearly separable features
  - A final linear classifier that operates on the linearly separable features

# An SVM at the output?

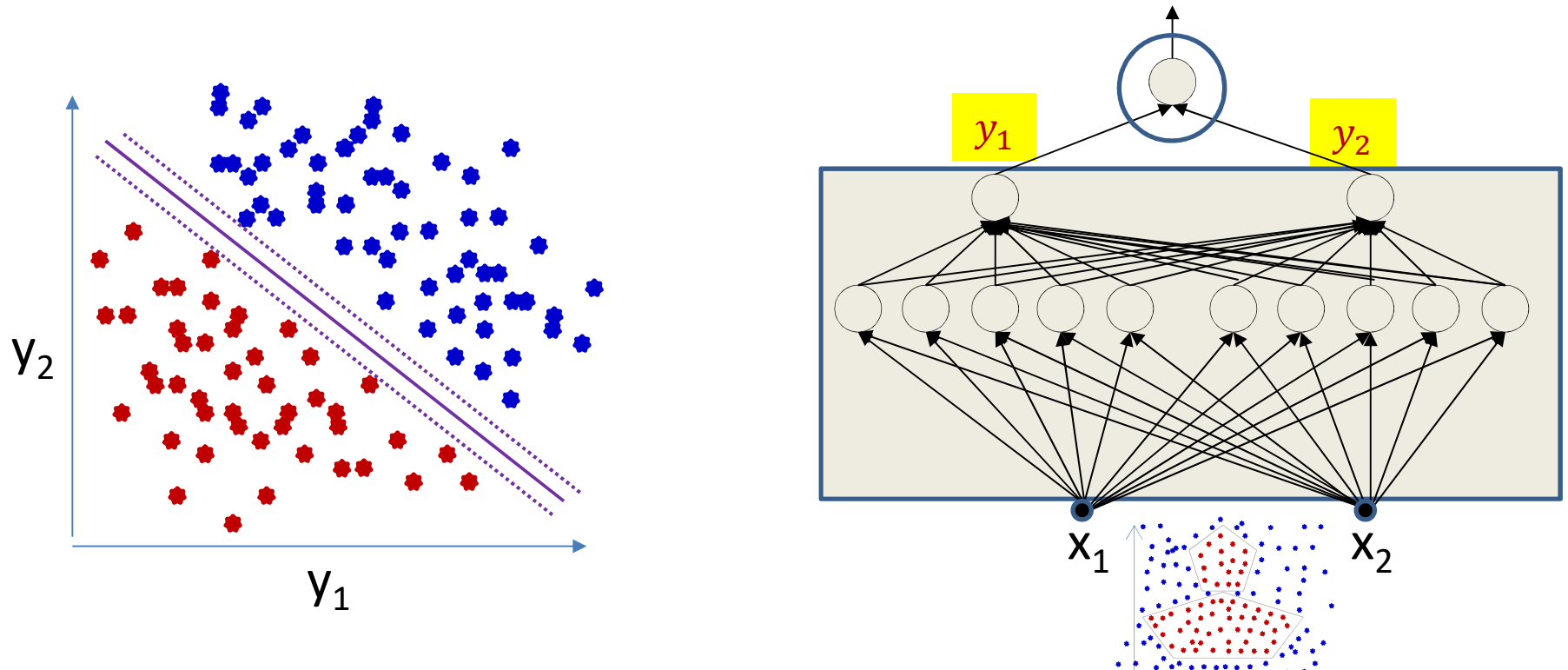

- For binary problems, using an SVM with slack may be more effective than a final perceptron!
- How does that work??
  - *Option 1:* First train the MLP with a perceptron at the output, then detach the feature extraction, compute features, and train an SVM
  - *Option 2:* Directly employ a max-margin rule at the output, and optimize the entire network
    - Left as an exercise for the curious

# How about the lower layers?

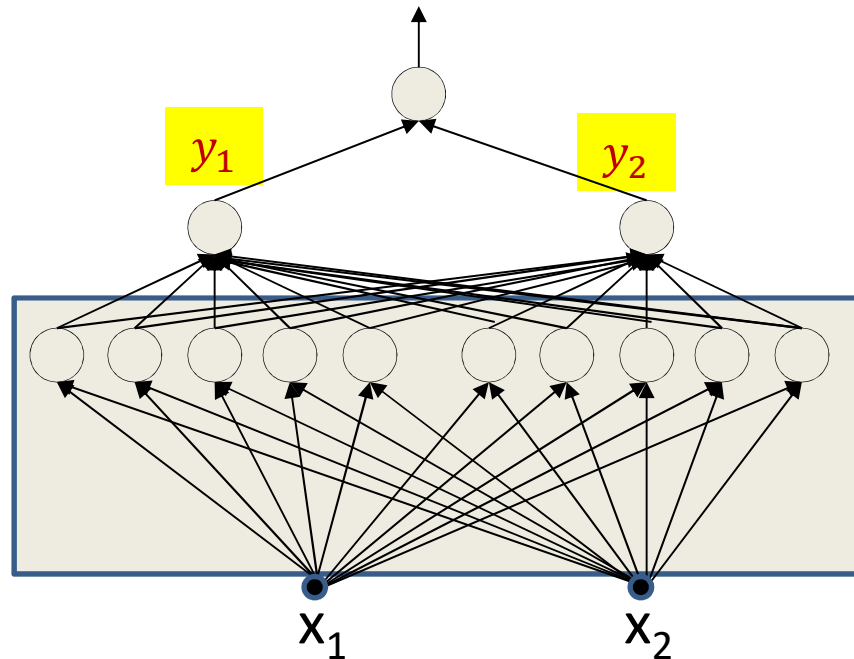

- How do the lower layers respond?
  - They too compute features
  - But how do they look
- Manifold hypothesis: For separable classes, the classes are linearly separable on a non-linear manifold
- Layers sequentially “straighten” the data manifold
  - Until the final layer, which fully linearizes it

# The behavior of the layers

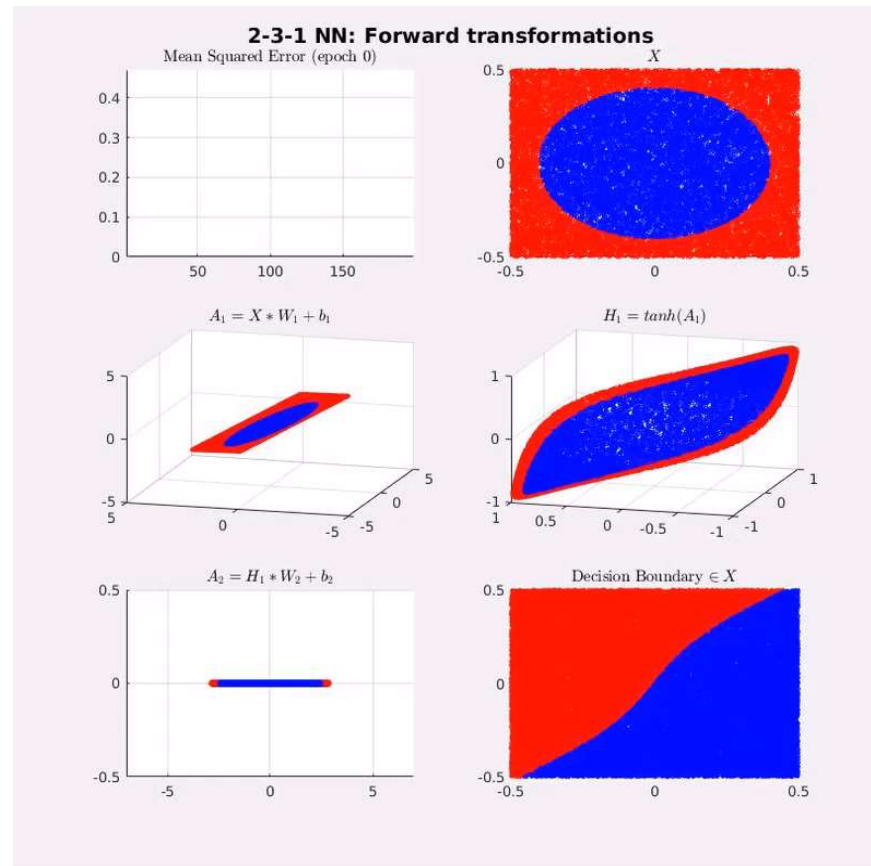

- Synthetic example: Feature space

# The behavior of the layers

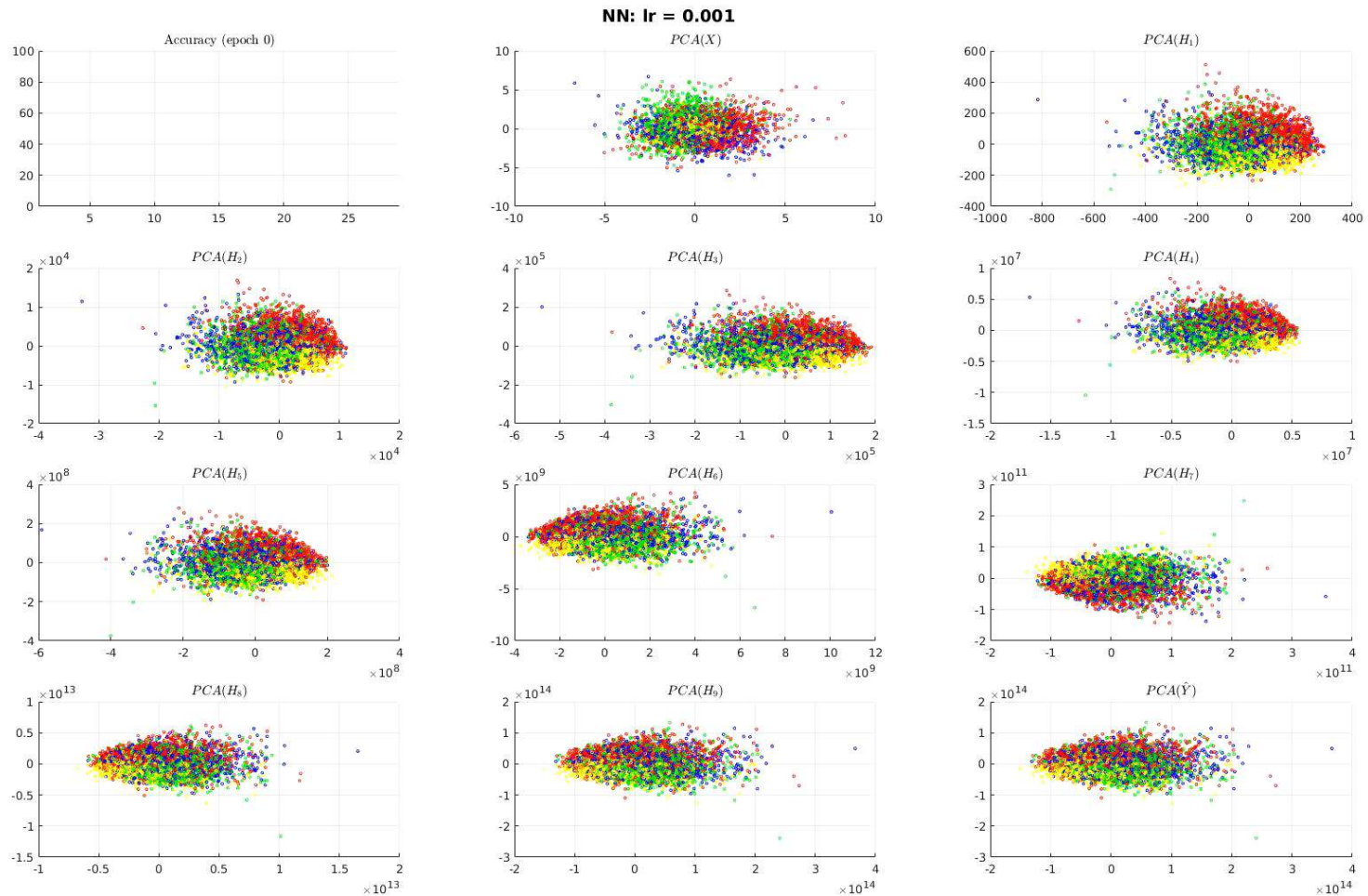

- CIFAR



# The behavior of the layers

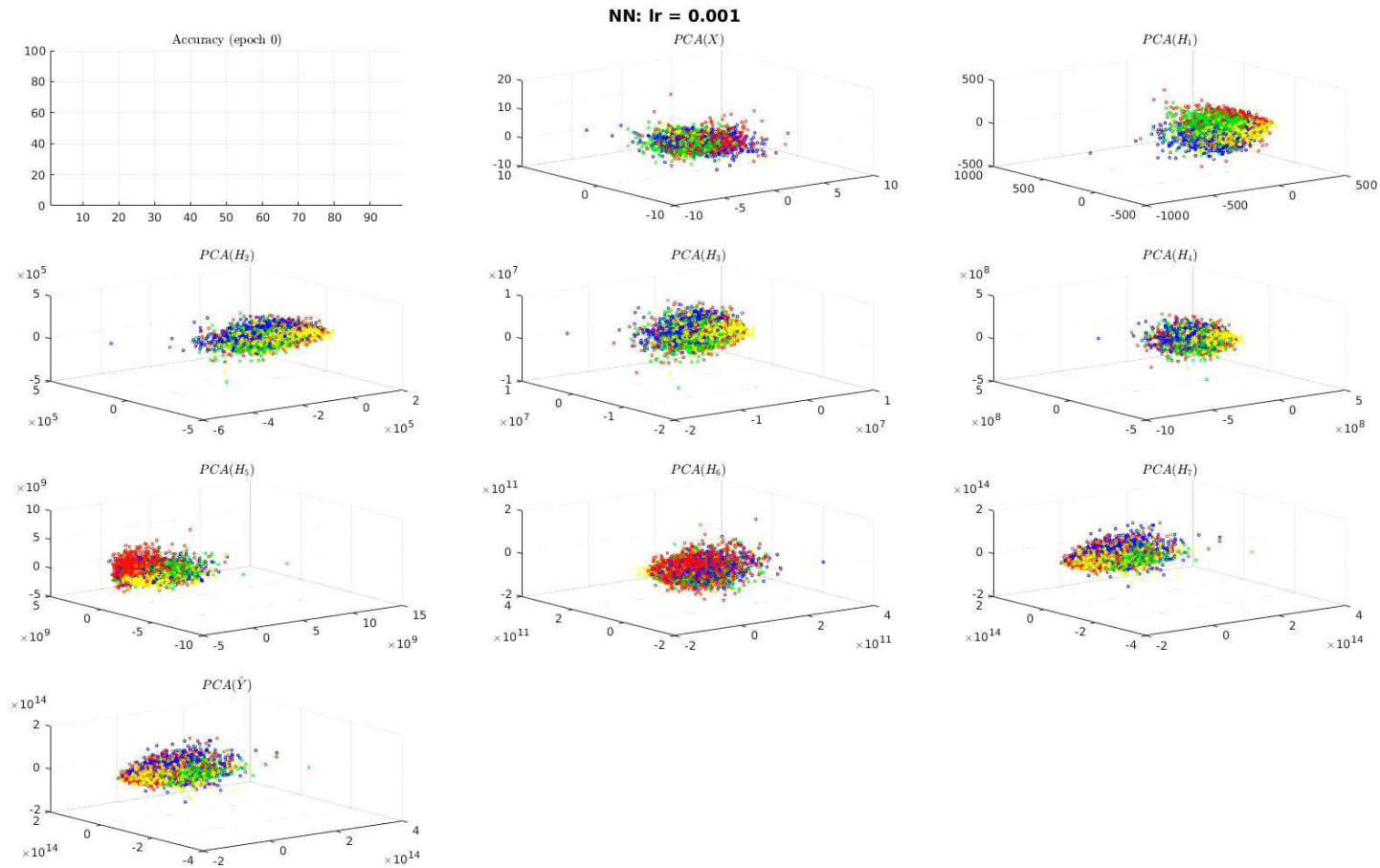

- CIFAR

# When the data are not separable and boundaries are not linear.

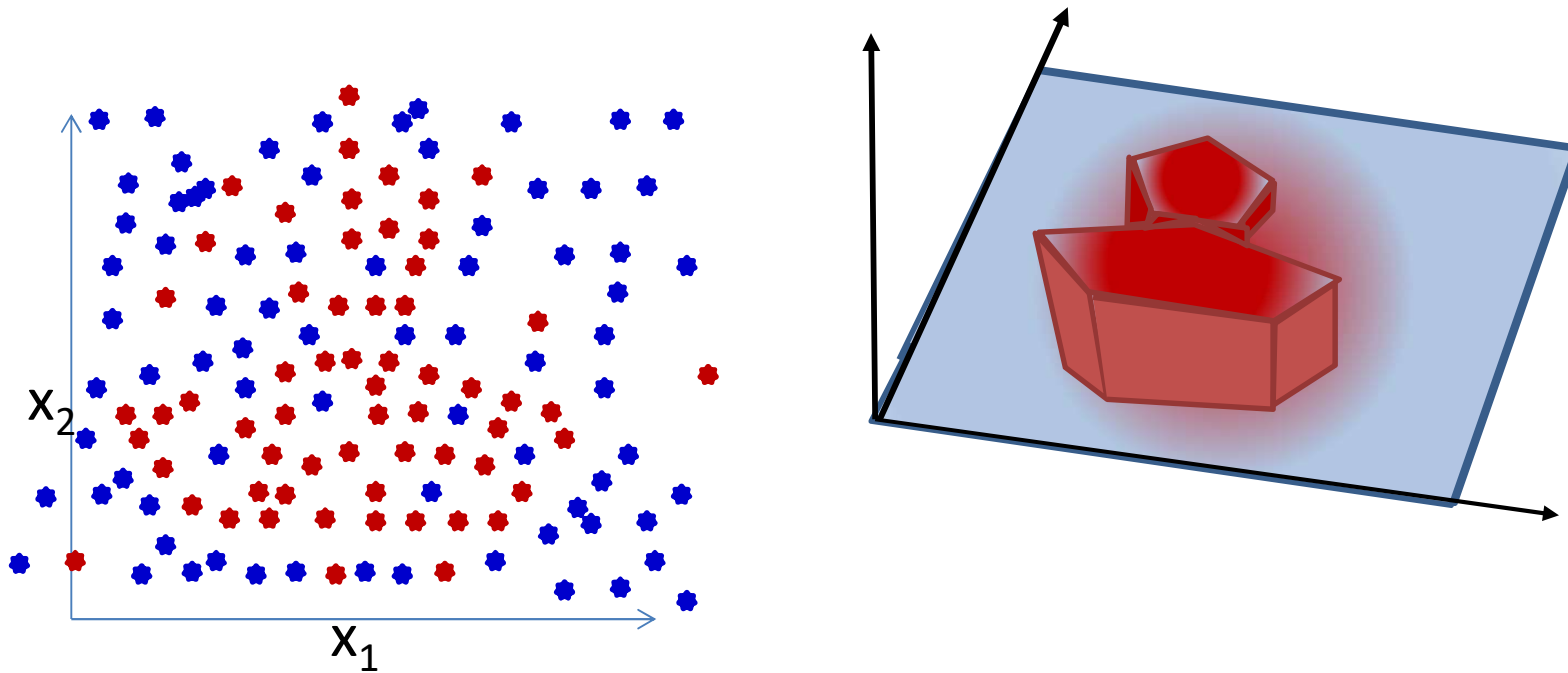

- More typical setting for classification problems

# Inseparable classes with an output logistic perceptron

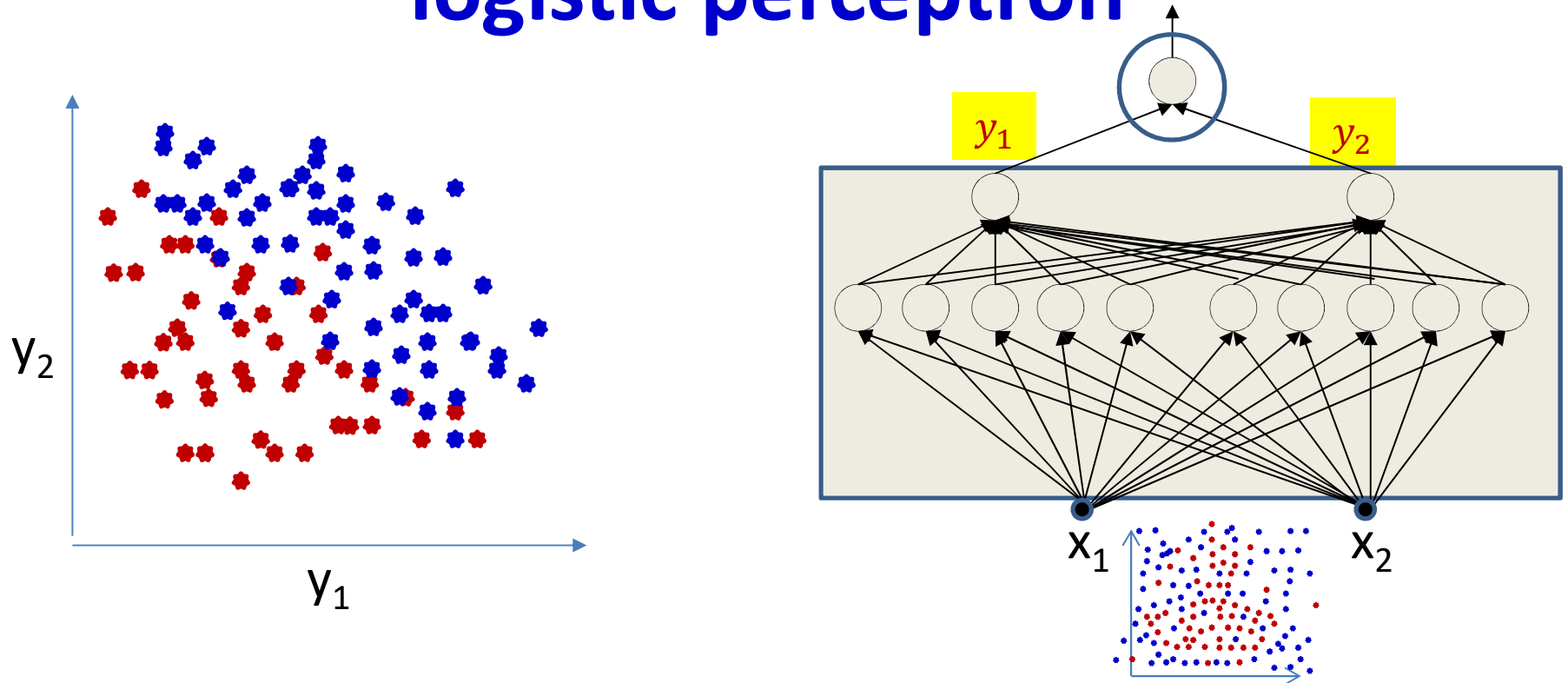

- The “feature extraction” layer transforms the data such that the posterior probability may now be modelled by a logistic

# Inseparable classes with an output logistic perceptron

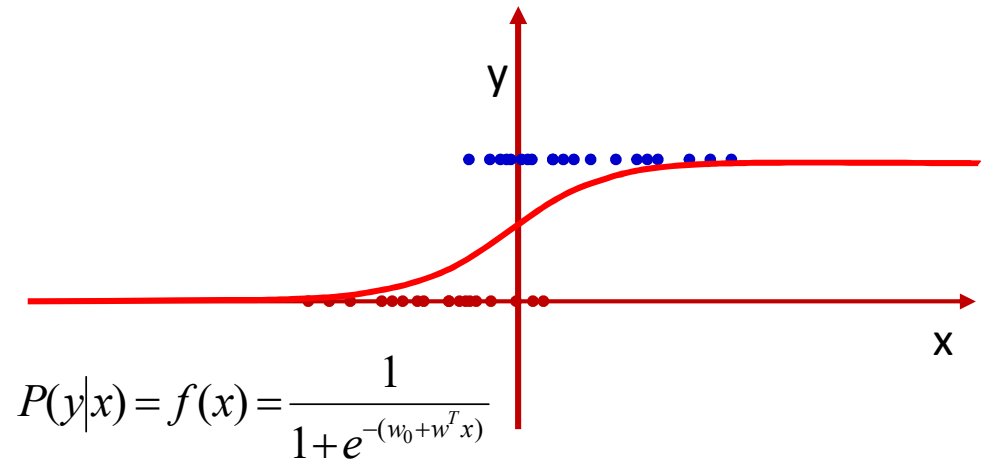
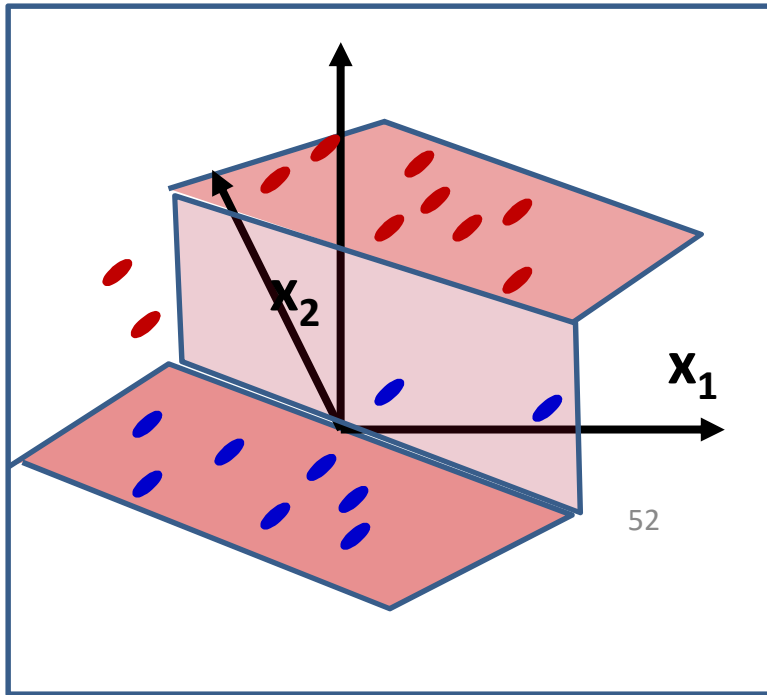

- The “feature extraction” layer transforms the data such that the posterior probability may now be modelled by a logistic
  - The output logistic computes the posterior probability of the class given the input

# When the data are not separable and boundaries are not linear.

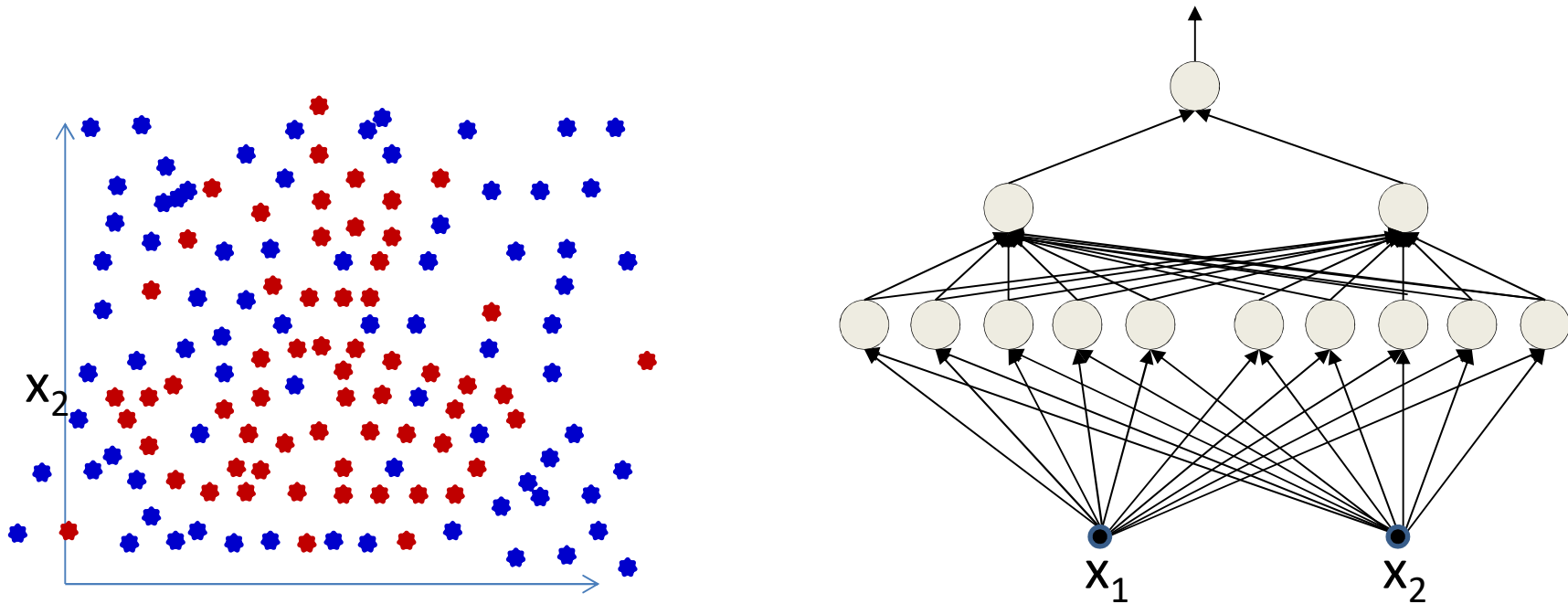

- The output of the network is  $P(y|x)$ 
  - For multi-class networks, it will be the *vector* of a posteriori class probabilities

*Everything in this book may be wrong!*

- Richard Bach (Illusions)



# There's no such thing as inseparable classes

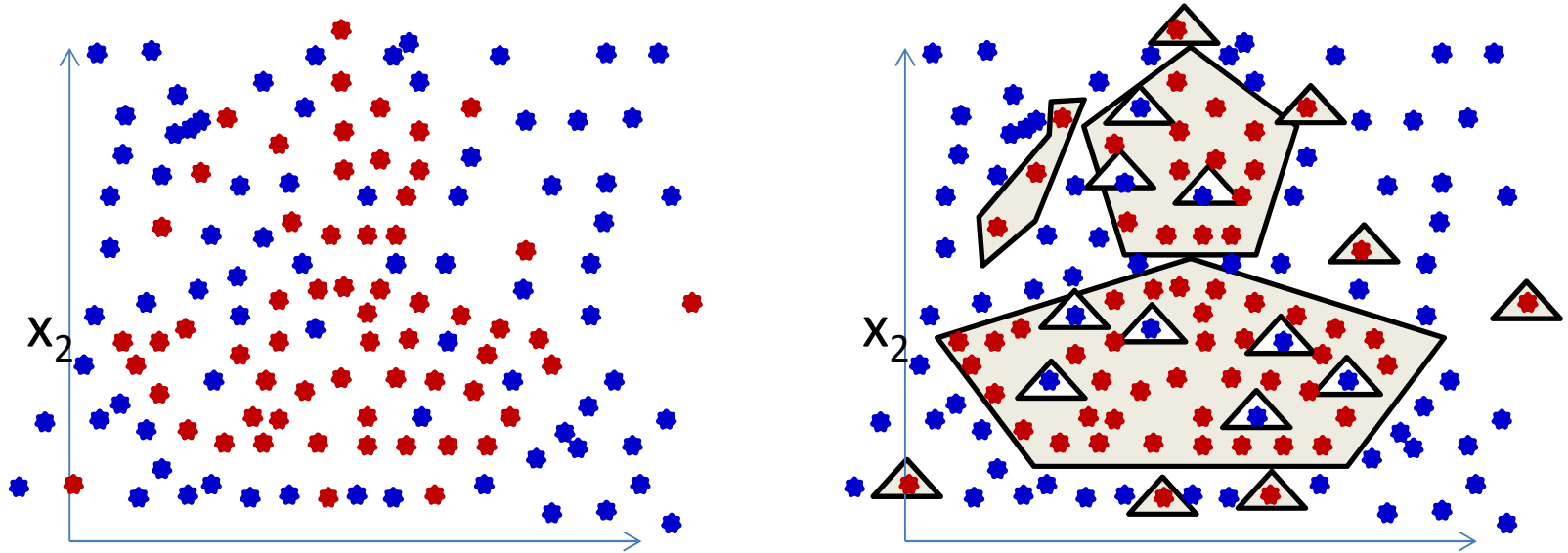

- A sufficiently detailed architecture can separate nearly *any* arrangement of points
  - “Correctness” of the suggested intuitions subject to various parameters, such as regularization, detail of network, training paradigm, convergence etc..

# Changing gears..

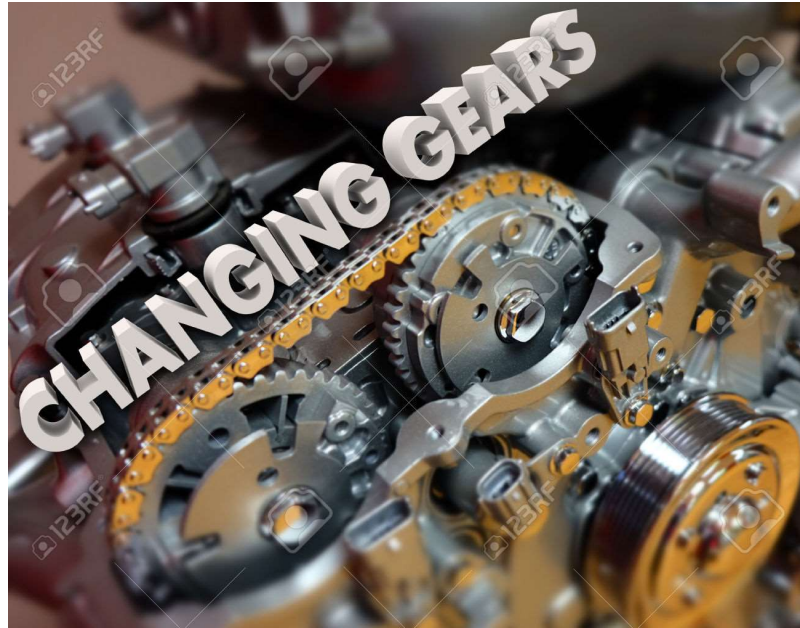



# Intermediate layers

We've seen what the network learns here

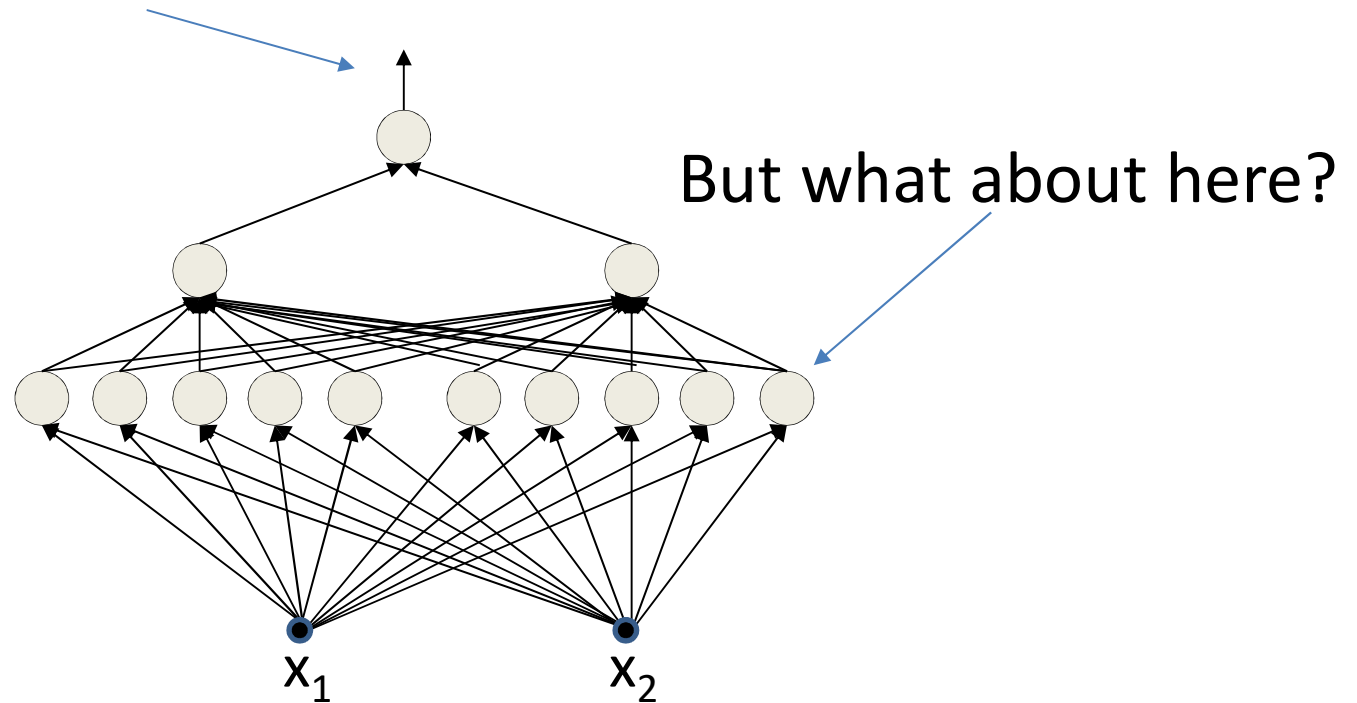

# Recall: The basic perceptron

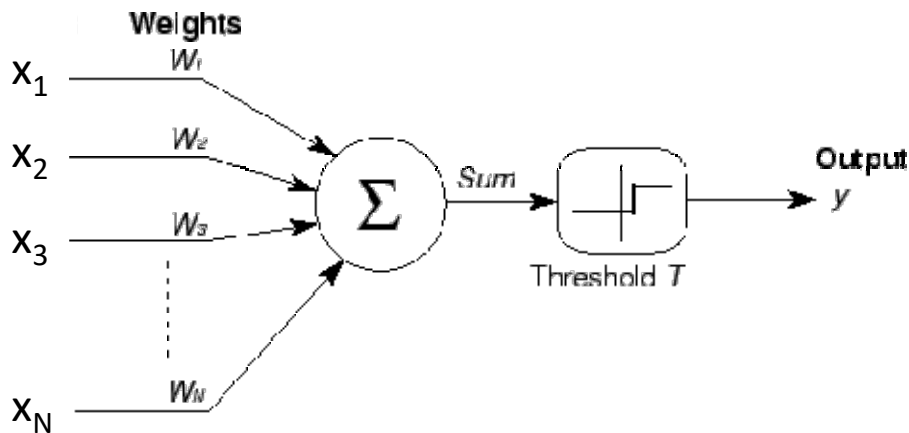

$$y = \begin{cases} 1 & \text{if } \sum_i w_i x_i \geq T \\ 0 & \text{else} \end{cases}$$

$$y = \begin{cases} 1 & \text{if } \mathbf{x}^T \mathbf{w} \geq T \\ 0 & \text{else} \end{cases}$$

- What do the *weights* tell us?
  - The neuron fires if the inner product between the weights and the inputs exceeds a threshold

# Recall: The weight as a “template”

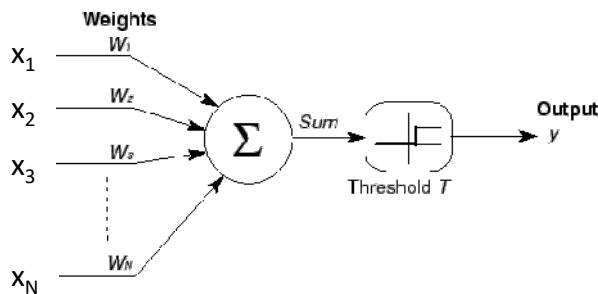

$$X^T W > T$$
$$\cos \theta > \frac{T}{|X|}$$
$$\theta < \cos^{-1} \left( \frac{T}{|X|} \right)$$

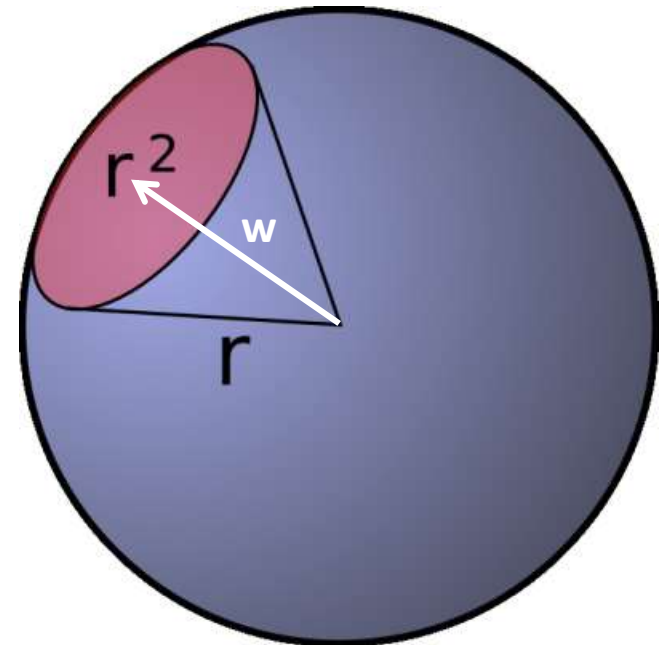

- The perceptron fires if the input is within a specified angle of the weight
  - Represents a convex region on the surface of the sphere!
  - The network is a Boolean function over these regions.
    - The overall decision region can be arbitrarily nonconvex
- Neuron fires if the input vector is close enough to the weight vector.
  - If the input pattern matches the weight pattern closely enough

# Recall: The weight as a template

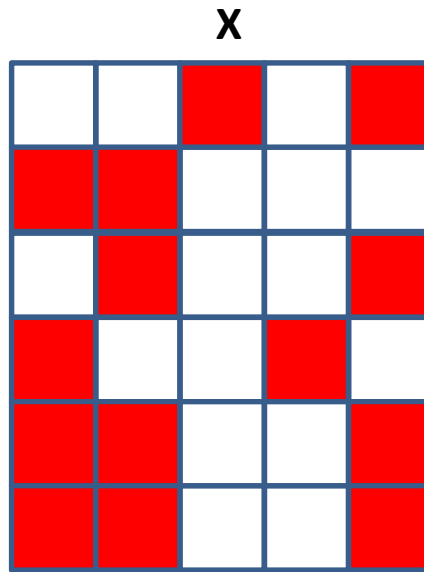
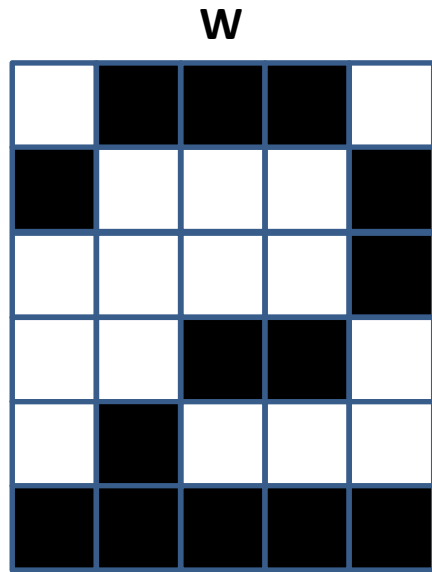

Correlation = 0.57

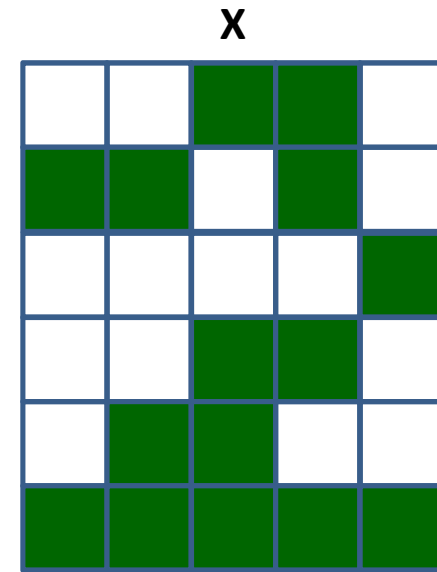

Correlation = 0.82



$$y = \begin{cases} 1 & \text{if } \sum_i w_i x_i \geq T \\ 0 & \text{else} \end{cases}$$

- If the *correlation* between the weight pattern and the inputs exceeds a threshold, fire
- The perceptron is a *correlation filter*!

# Recall: MLP features

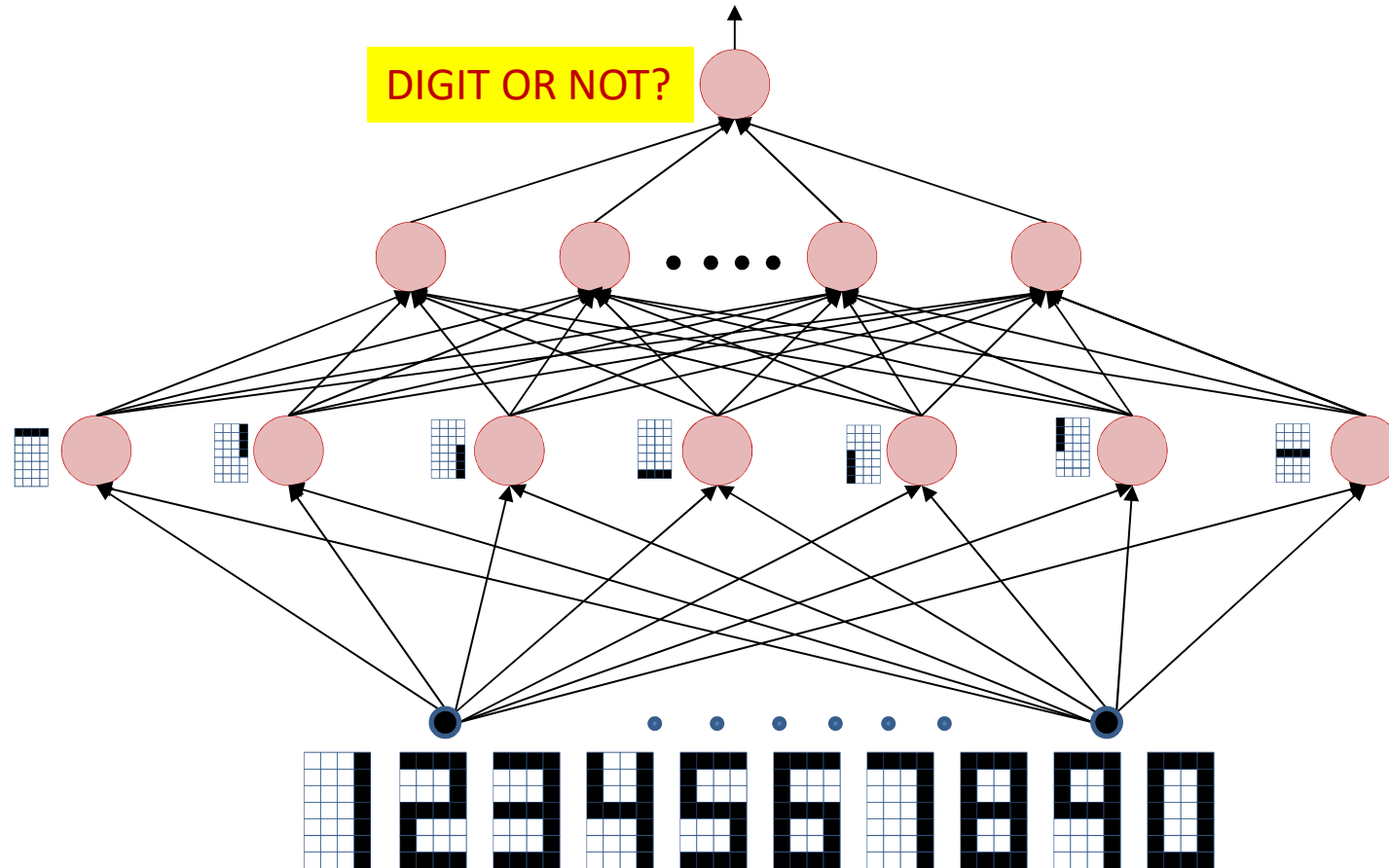

- The lowest layers of a network detect significant features in the signal
- **The signal could be (partially) reconstructed using these features**
  - Will retain all the significant components of the signal

# Making it explicit

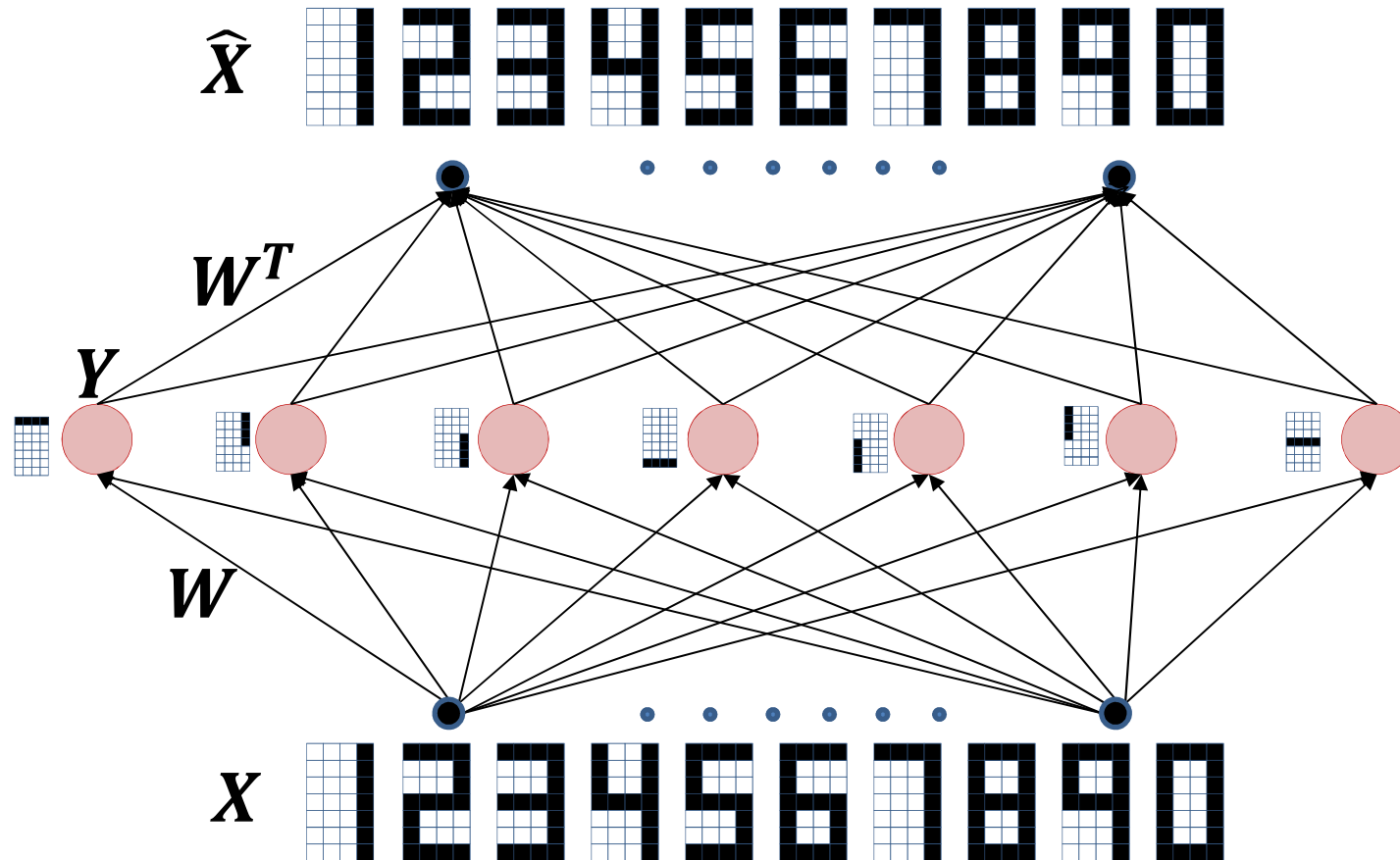

- **The signal could be (partially) reconstructed using these features**
  - Will retain all the significant components of the signal
- Simply *recompose* the detected features
  - Will this work?

# Making it explicit

$\hat{X}$  1 2 3 4 5 6 7 8 9 0

$WT$

$X$

$X$  1 2 3 4 5 6 7 8 9 0

Not in this problem.  
The network is optimized to recognize digits  
Will only retain distinctly digit-like or obviously not-digit like features  
Rest are irrelevant and will be lost

- The signal could be (partially) reconstructed using these features
  - Will retain all the significant components of the signal
- Simply *recompose* the detected features
  - Will this work?

# Making it explicit: an autoencoder

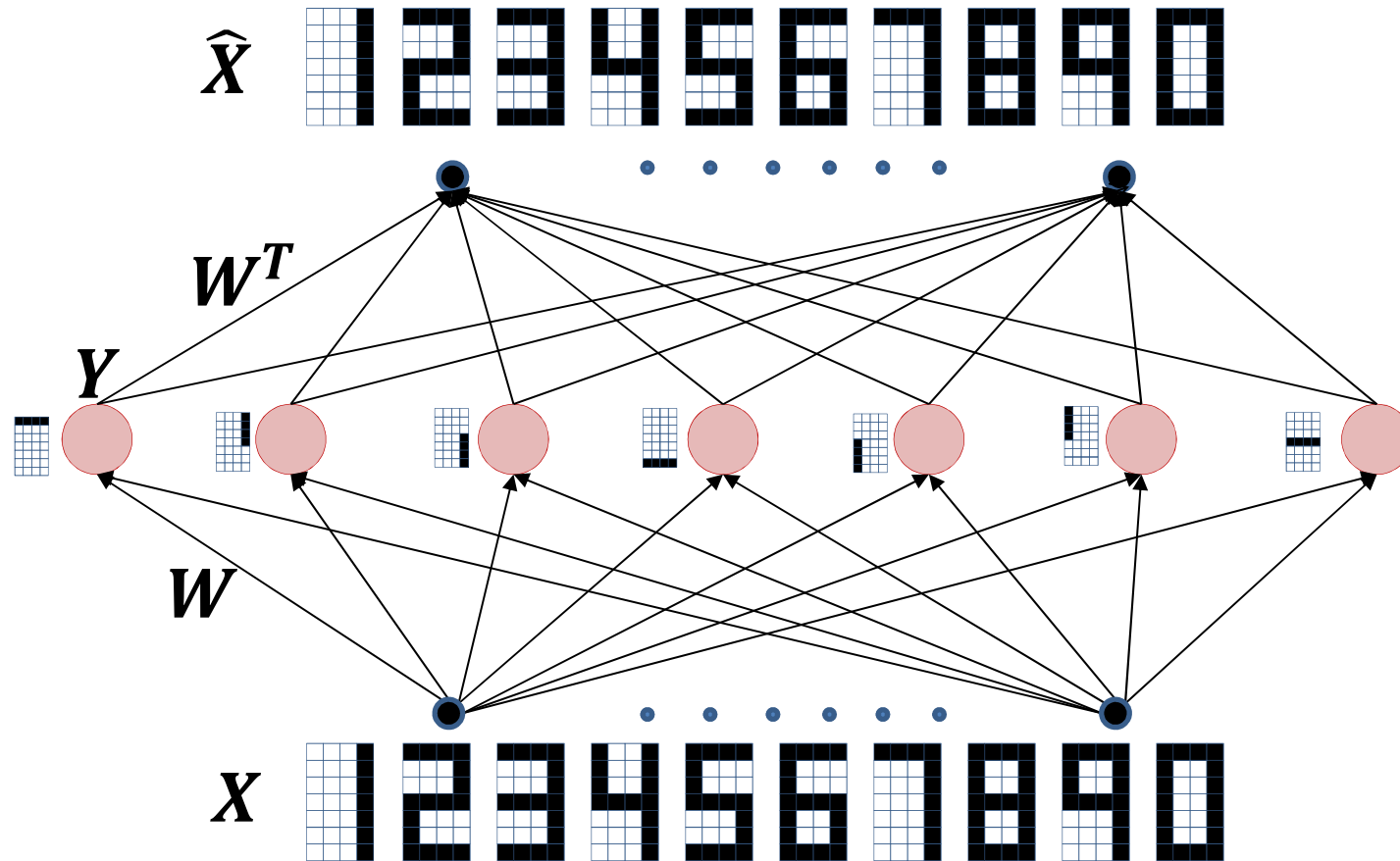

- A neural network can be trained to predict the input itself
- This is an *autoencoder*
- An *encoder* learns to detect all the most significant patterns in the signals
- A *decoder* recomposes the signal from the patterns



# The Simplest Autencoder

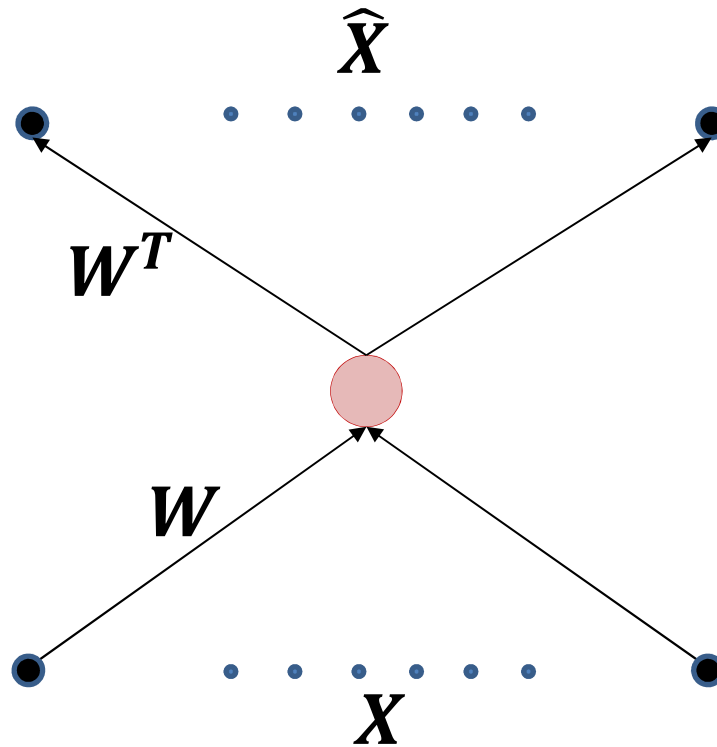

- A single hidden unit
- Hidden unit has *linear* activation
- What will this learn?

# The Simplest Autencoder

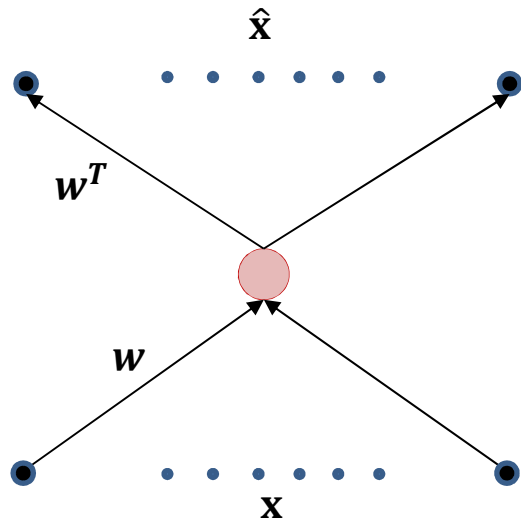

Training: Learning  $W$  by minimizing L2 divergence

$$\hat{x} = w^T w x$$

$$div(\hat{x}, x) = \|x - \hat{x}\|^2 = \|x - w^T w x\|^2$$

$$\hat{W} = \underset{W}{\operatorname{argmin}} E[div(\hat{x}, x)]$$

$$\hat{W} = \underset{W}{\operatorname{argmin}} E[\|x - w^T w x\|^2]$$

- This is just PCA!

# The Simplest Autoencoder

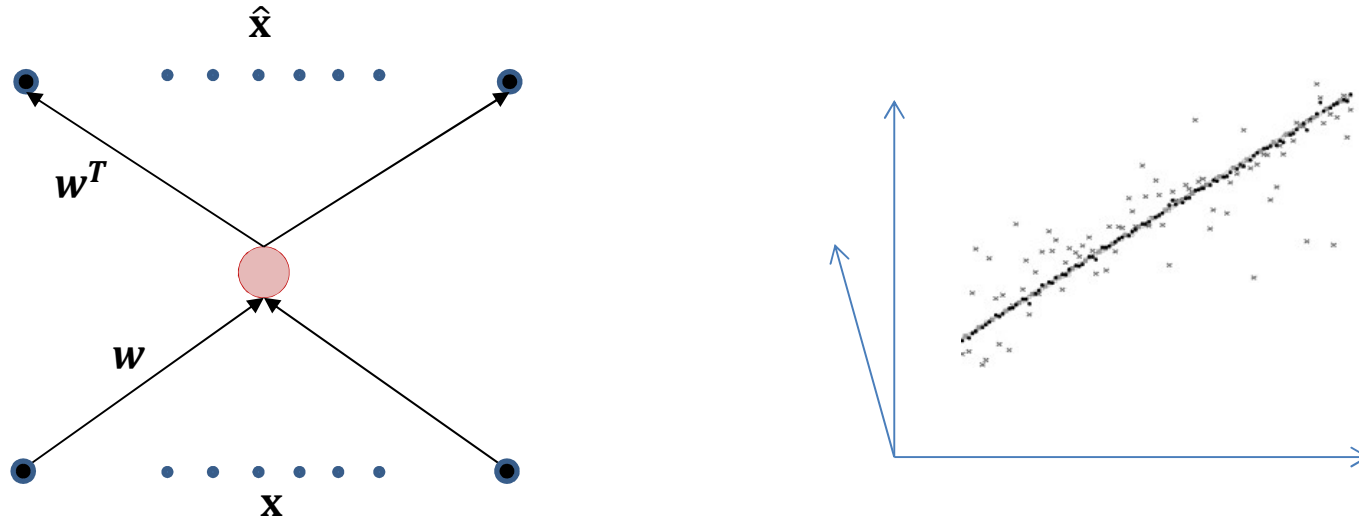

- The autoencoder finds the direction of maximum energy
  - Variance if the input is a zero-mean RV
- All input vectors are mapped onto a point on the principal axis

# The Simplest Autoencoder

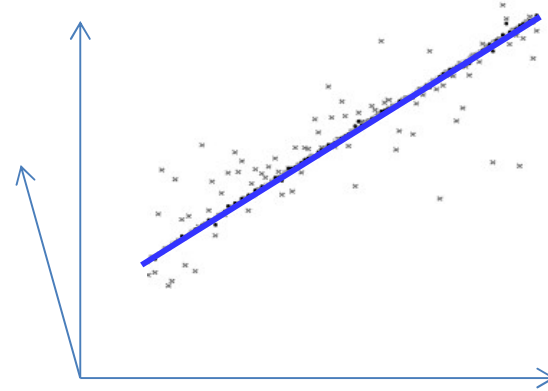
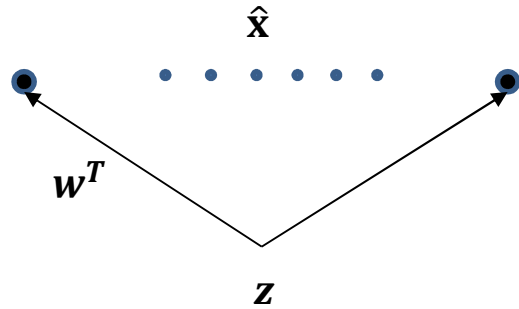

- Simply varying the hidden representation will result in an output that lies along the major axis

# The Simplest Autencoder

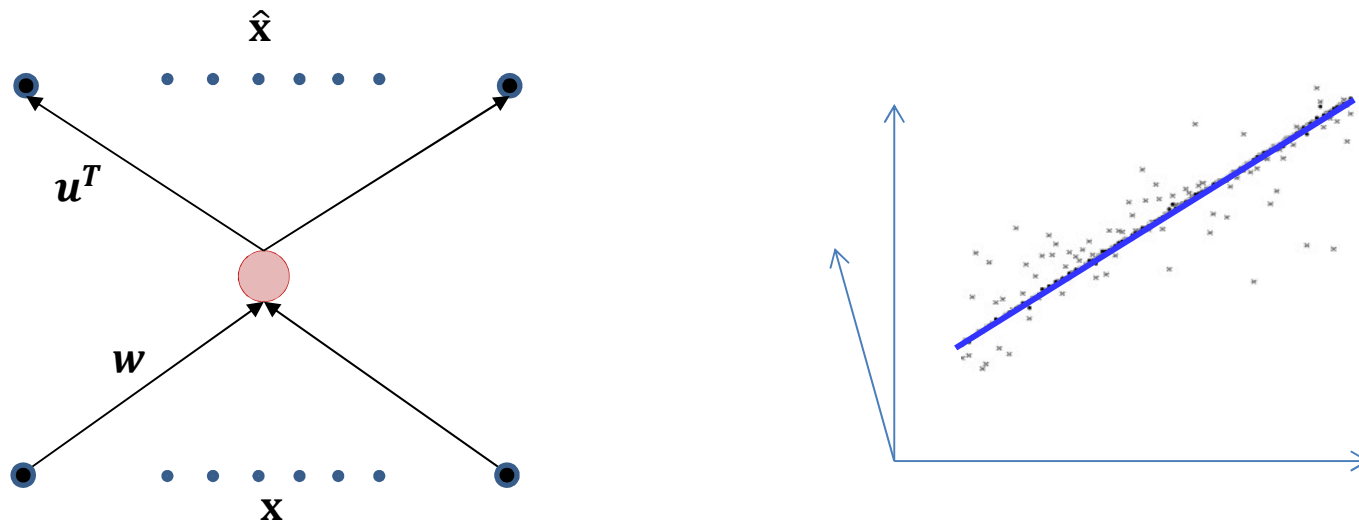

- Simply varying the hidden representation will result in an output that lies along the major axis
- This will happen even if the learned output weight is separate from the input weight
  - The minimum-error direction is the principal eigen vector

# For more detailed AEs without a non-linearity

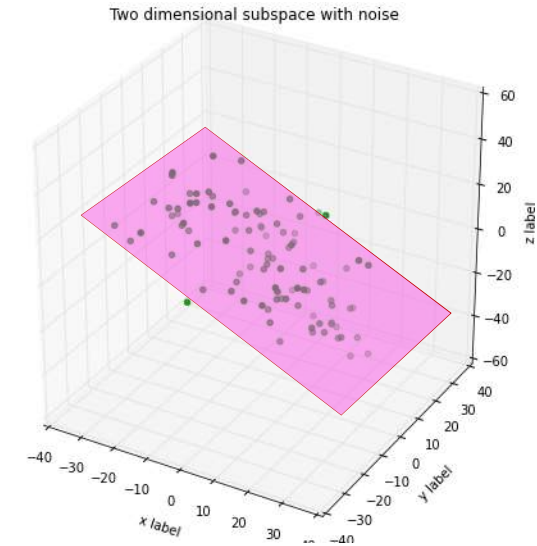
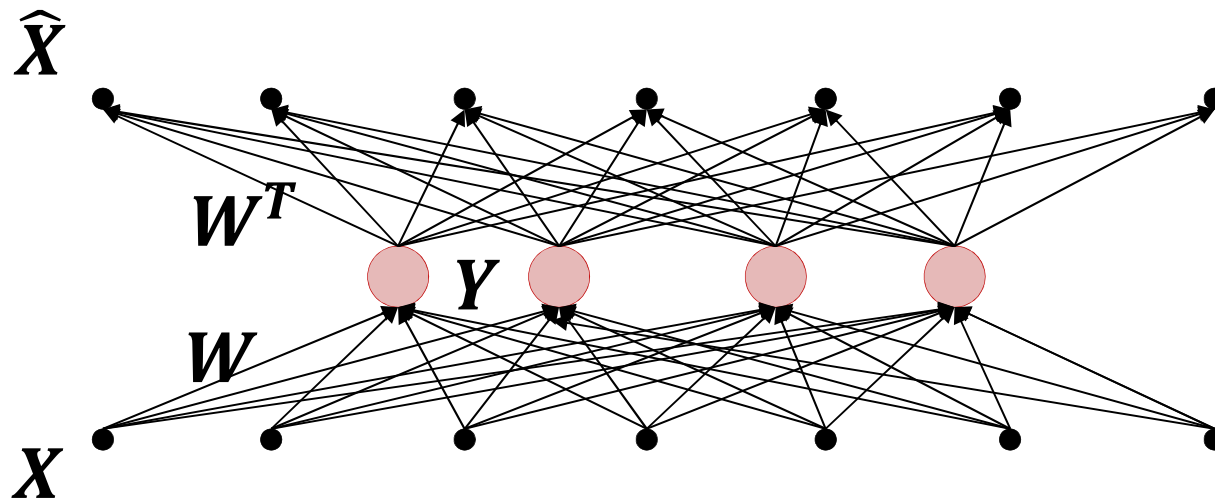

$$\boxed{Y = WX} \quad \boxed{\hat{X} = W^T Y} \quad E = \|X - W^T W X\|^2 \quad \text{Find } W \text{ to minimize Avg}[E]$$

- This is still just PCA
  - The output of the hidden layer will be in the principal subspace
    - Even if the recomposition weights are different from the “analysis” weights

# Terminology

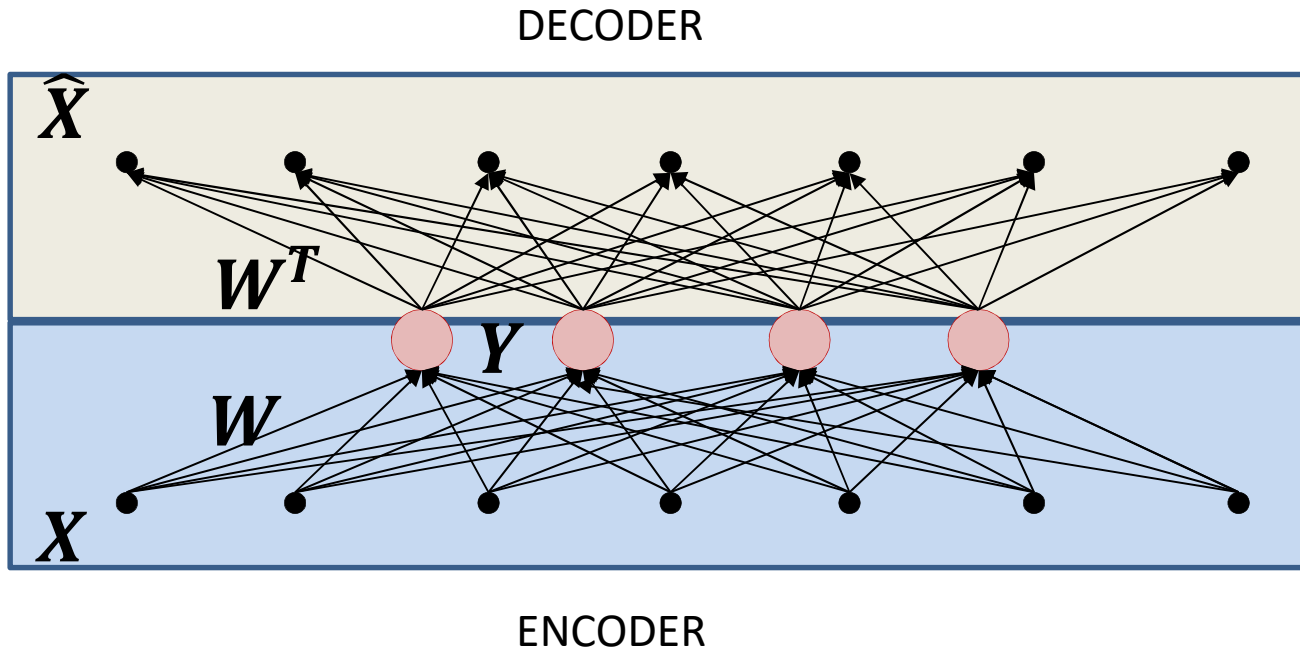

- Terminology:
  - **Encoder:** The “Analysis” net which computes the hidden representation
  - **Decoder:** The “Synthesis” which recomposes the data from the hidden representation

# Introducing *nonlinearity*

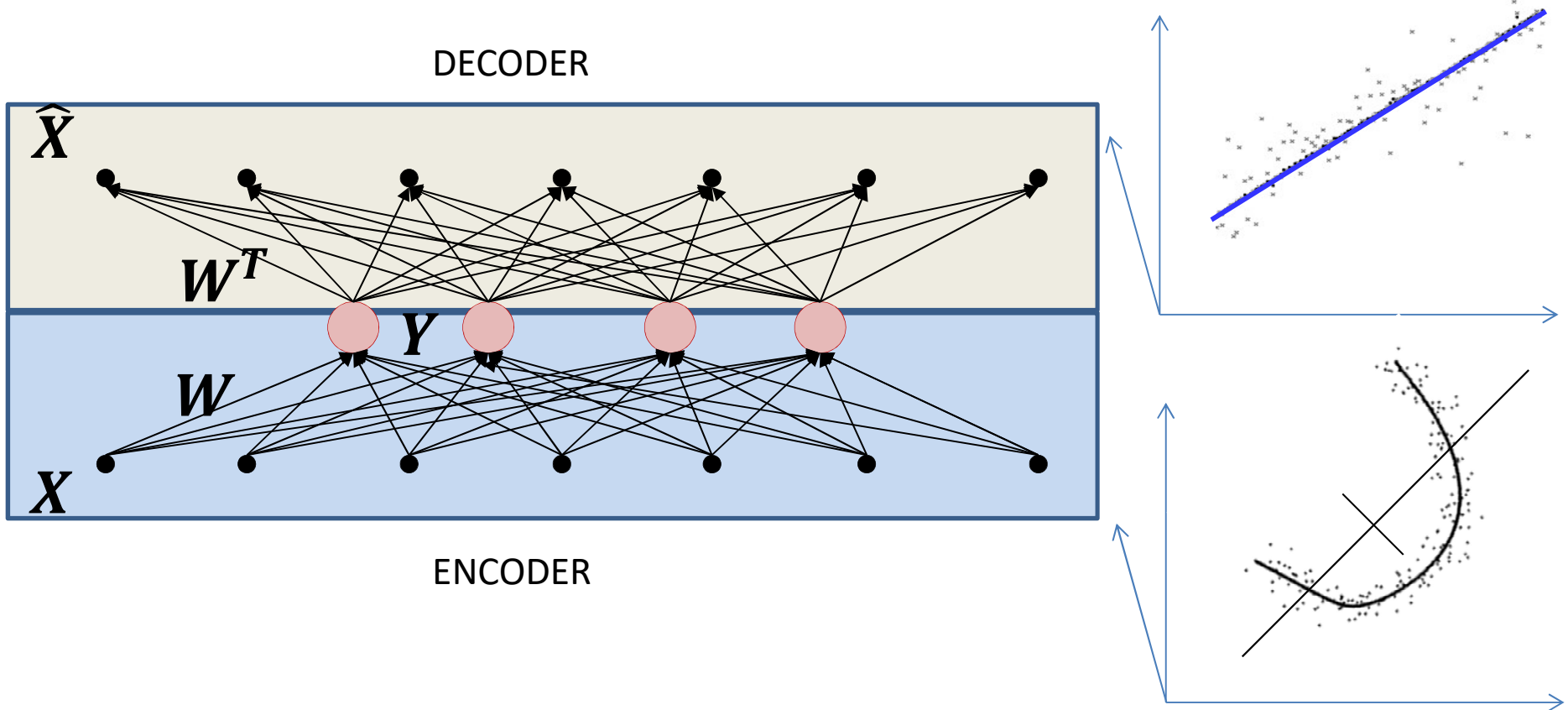

- When the hidden layer has a *linear* activation the decoder represents the best *linear* manifold to fit the data
  - Varying the hidden value will move along this linear manifold
- **When the hidden layer has non-linear activation, the net performs *nonlinear PCA***
  - The decoder represents the best non-linear manifold to fit the data
  - Varying the hidden value will move along this non-linear manifold



# The AE

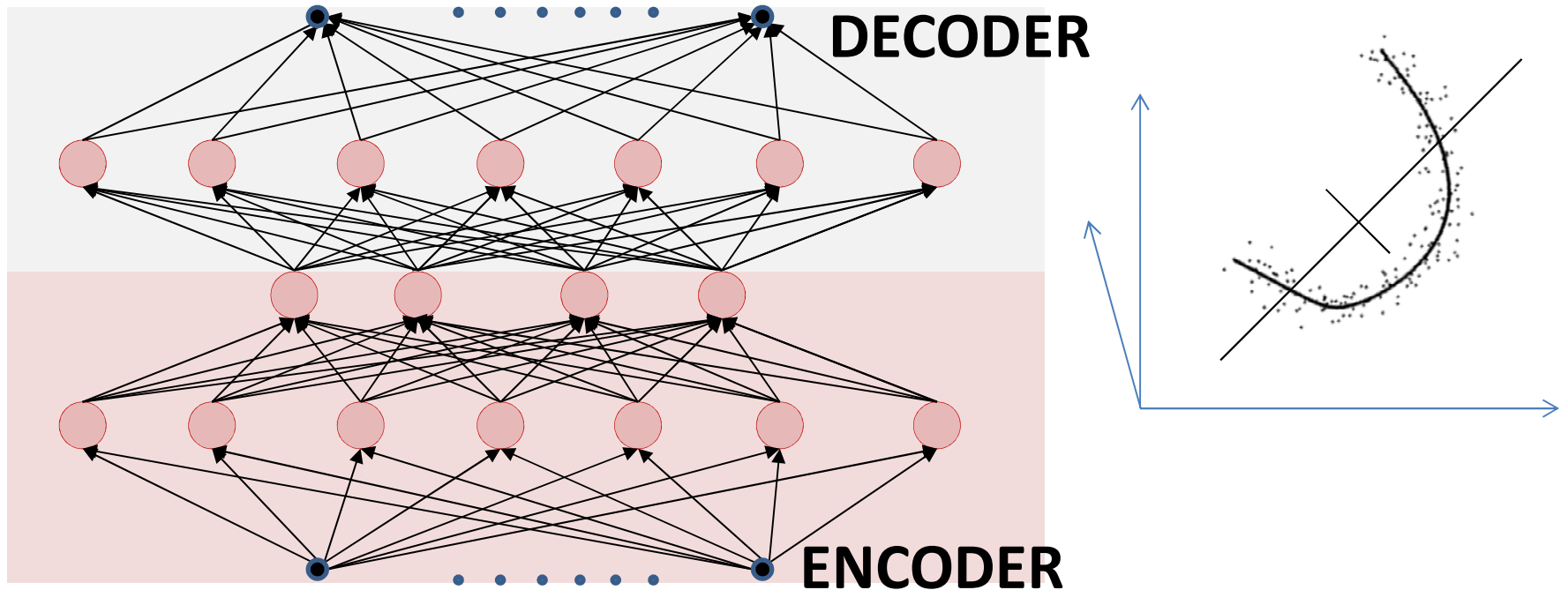

- With non-linearity
  - “Non linear” PCA
  - Deeper networks can capture more complicated manifolds
    - “Deep” autoencoders

# Some examples

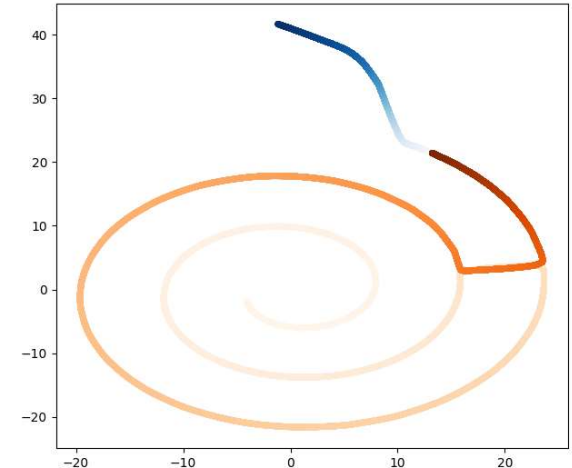
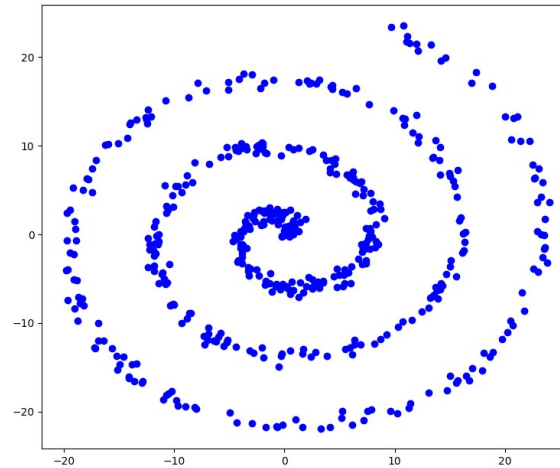
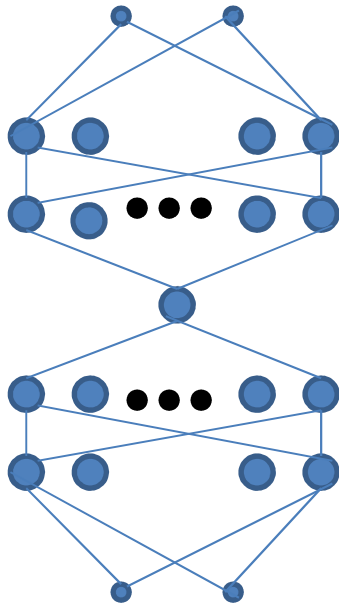

- 2-D input
- Encoder and decoder have 2 hidden layers of 100 neurons, but hidden representation is unidimensional
- Extending the hidden “z” value beyond the values seen in training does not continue along a helix

# Some examples

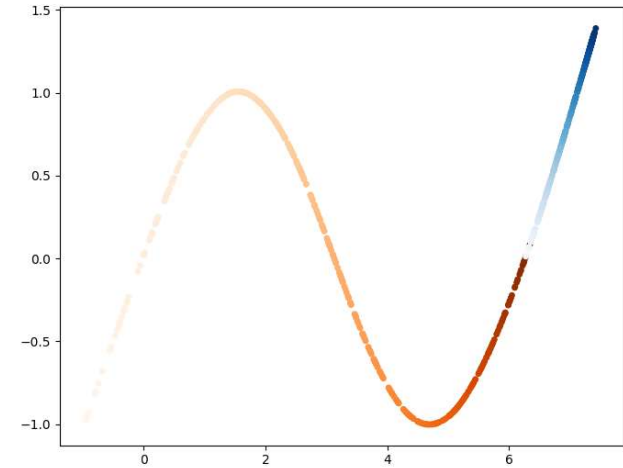
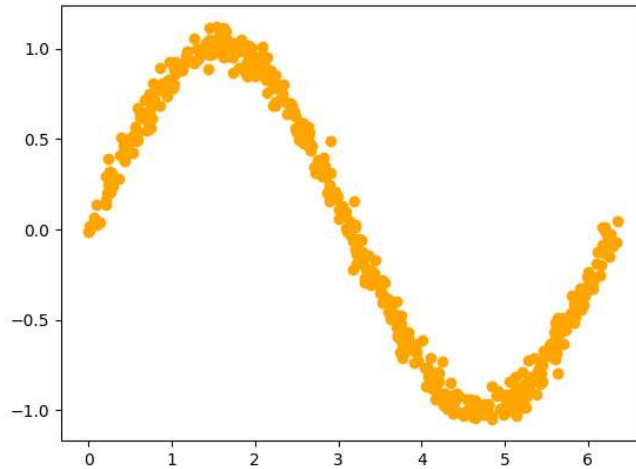
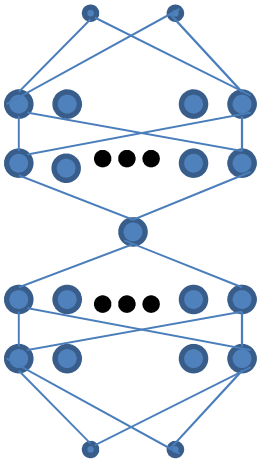

- The model is specific to the training data..
  - Varying the hidden layer value only generates data along the learned manifold
    - *Any input* will result in an output along the learned manifold
  - But may not generalize beyond the manifold

# The AE

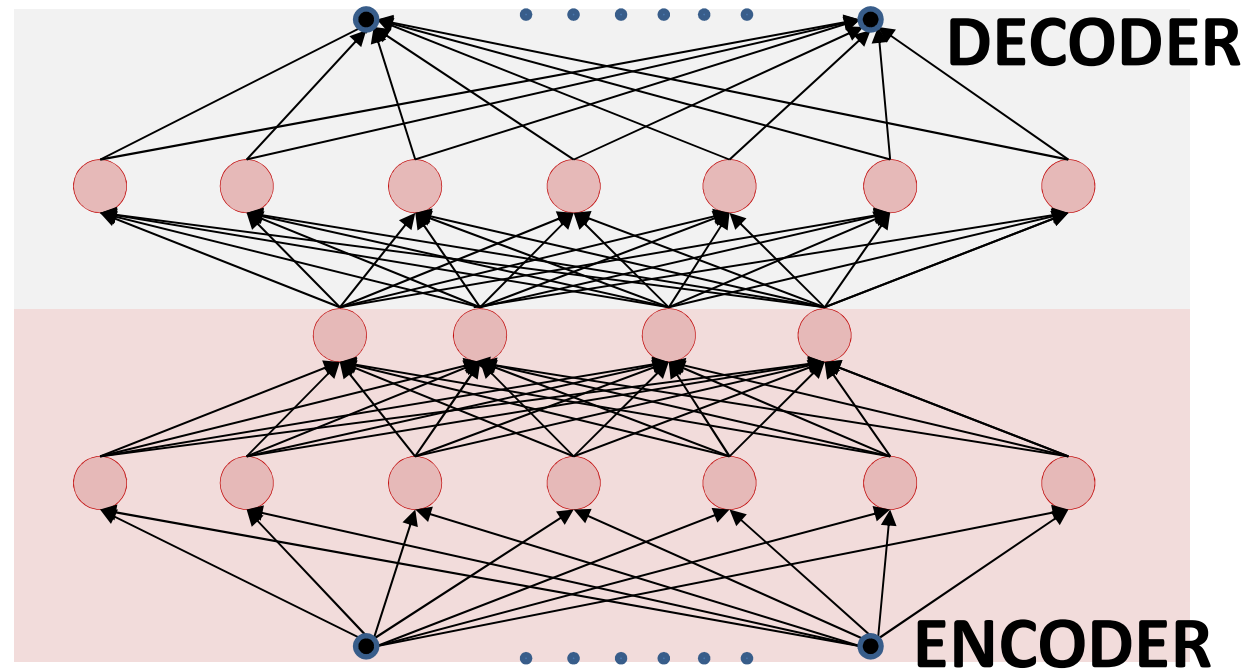

- When the hidden representation is of lower dimensionality than the input, often called a “**bottleneck**” network
  - Nonlinear PCA
  - Learns the manifold for the data
    - If properly trained

# The AE

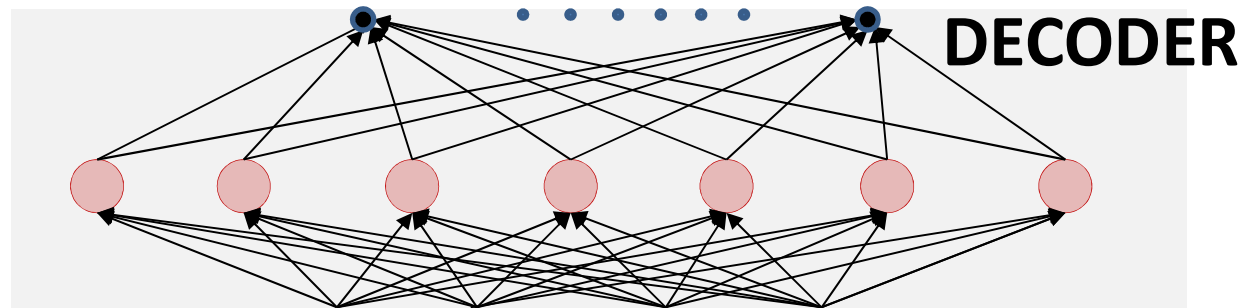

- The decoder can only generate data on the manifold that the training data lie on
- This also makes it an excellent “generator” of the distribution of the training data
  - Any values applied to the (hidden) input to the decoder will produce data similar to the training data

# The Decoder:

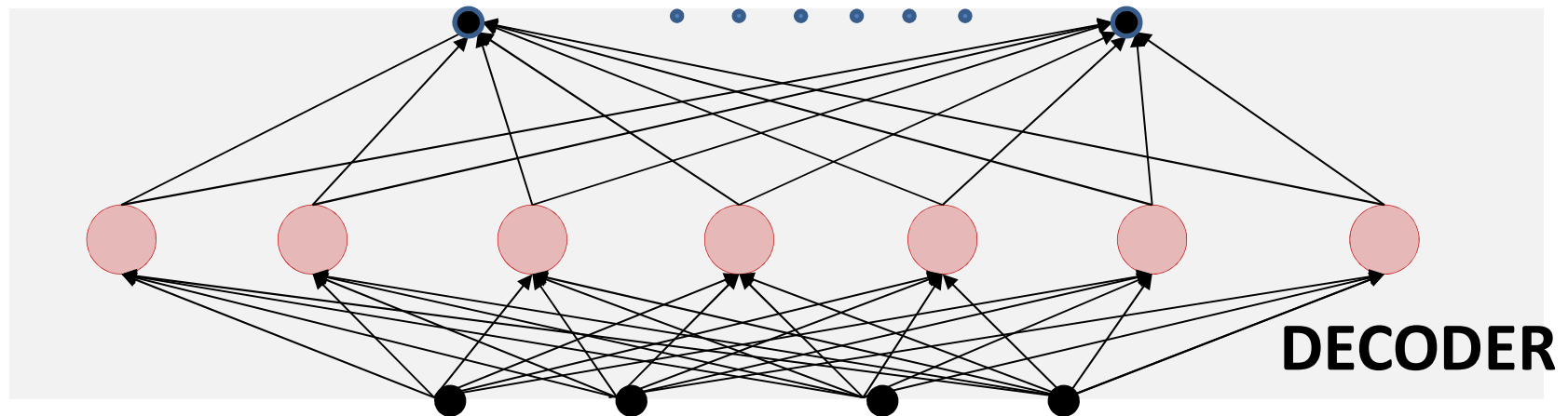
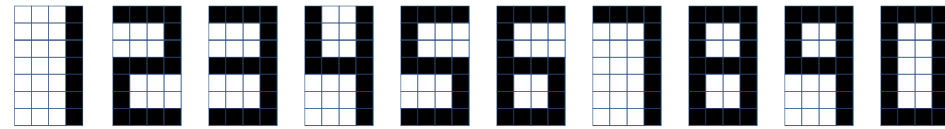

- The decoder represents a source-specific generative *dictionary*
- Exciting it will produce typical data from the source!

# The Decoder:

Sax dictionary

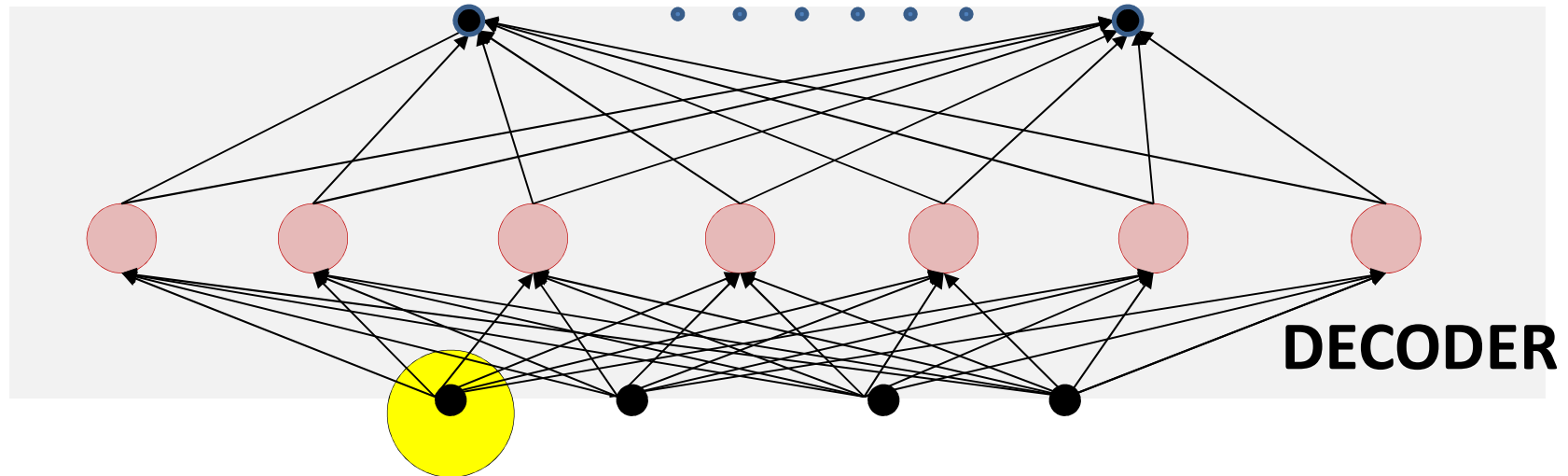

- The decoder represents a source-specific generative *dictionary*
- Exciting it will produce typical data from the source!

# The Decoder:

Clarinet dictionary

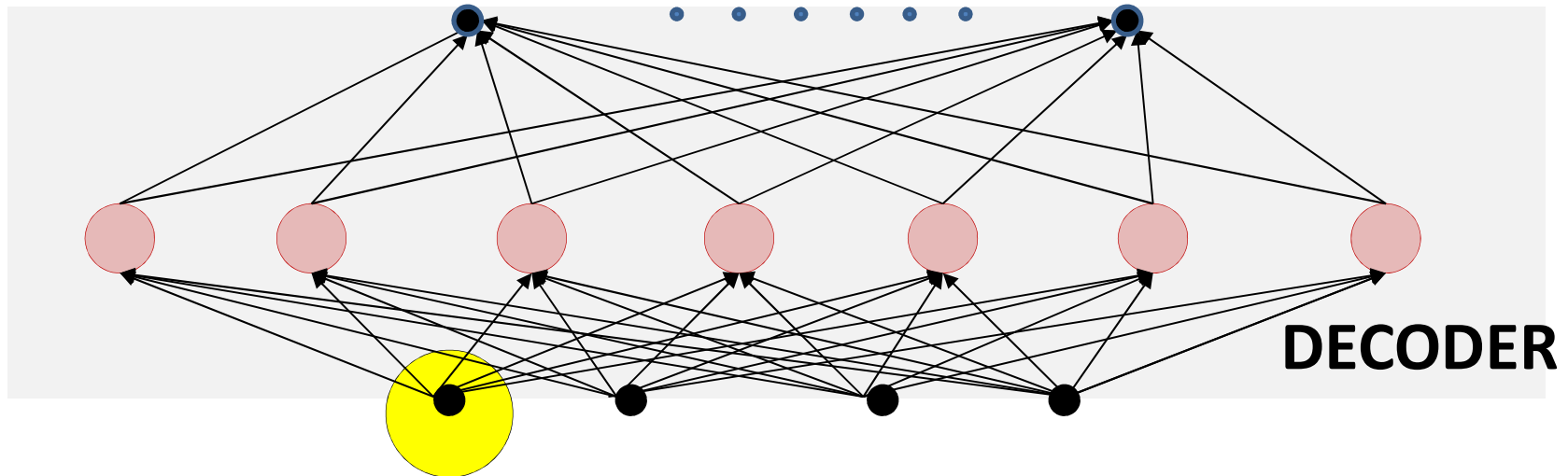

- The decoder represents a source-specific generative *dictionary*
- Exciting it will produce typical data from the source!



# A cute application..

- Signal separation...
- Given a mixed sound from multiple sources, separate out the sources

# Dictionary-based techniques

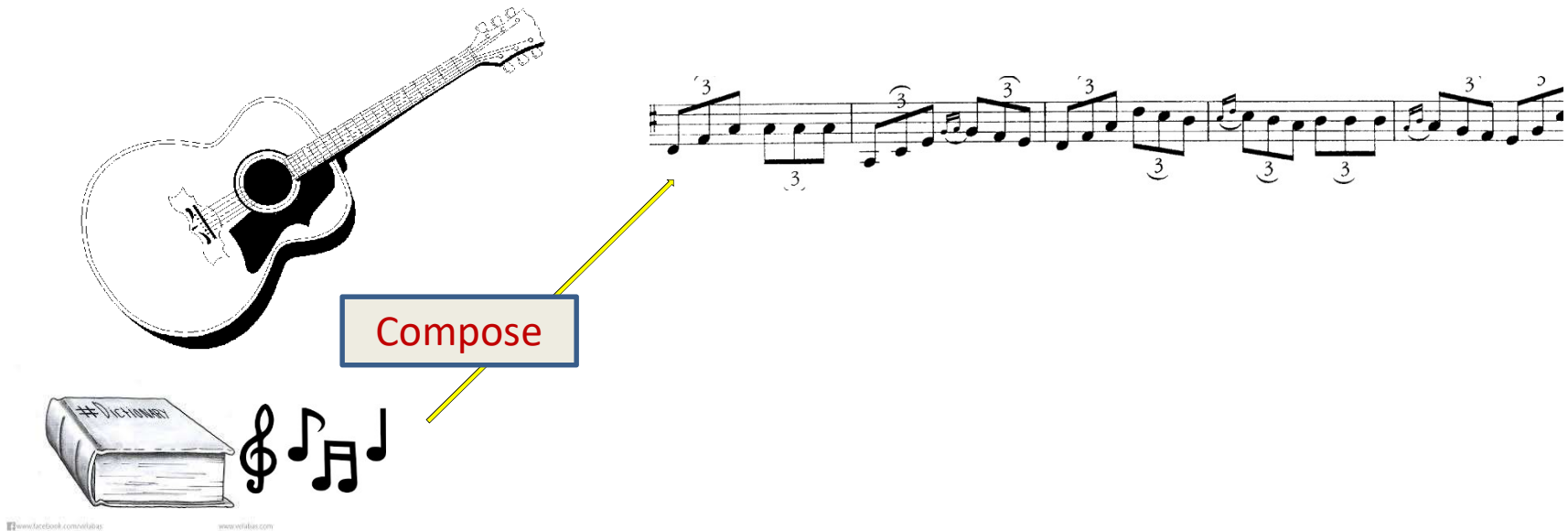

- Basic idea: Learn a dictionary of “building blocks” for each sound source
- All signals by the source are composed from entries from the dictionary for the source

# Dictionary-based techniques

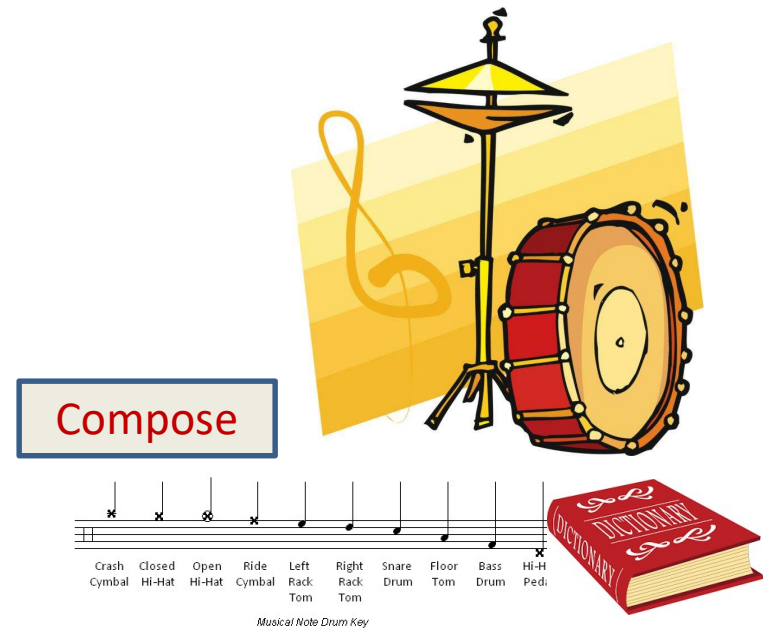

- Learn a similar dictionary for all sources expected in the signal

# Dictionary-based techniques

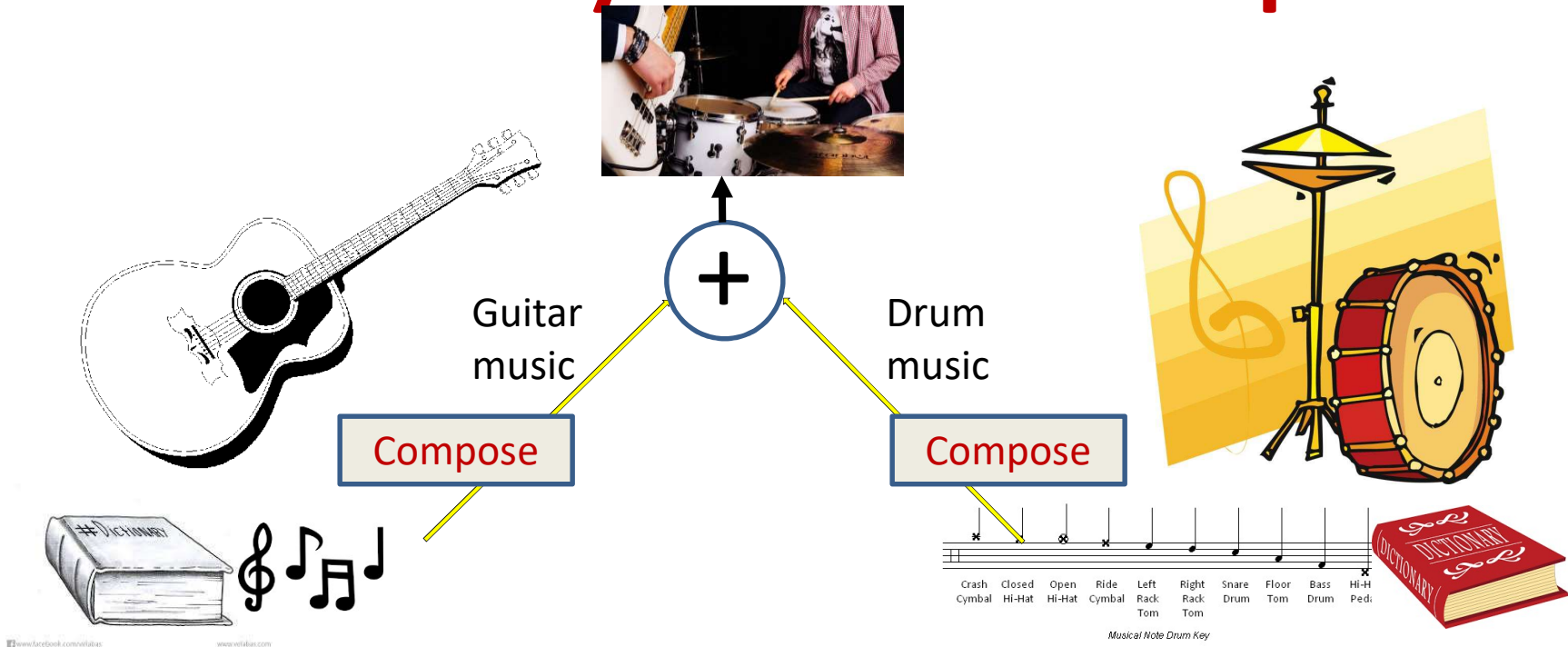

- A mixed signal is the linear combination of signals from the individual sources
  - Which are in turn composed of entries from its dictionary

# Dictionary-based techniques

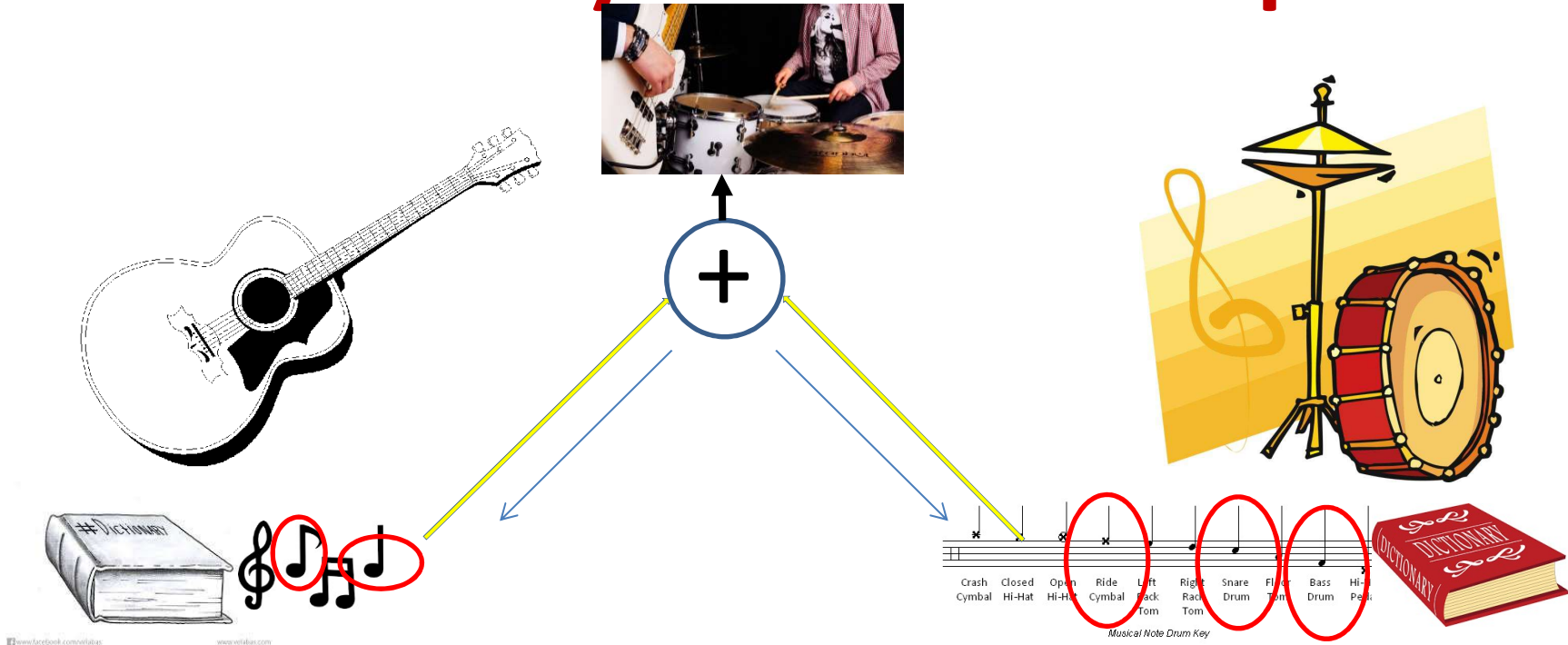

- Separation: Identify the combination of entries from both dictionaries that compose the mixed signal

# Dictionary-based techniques

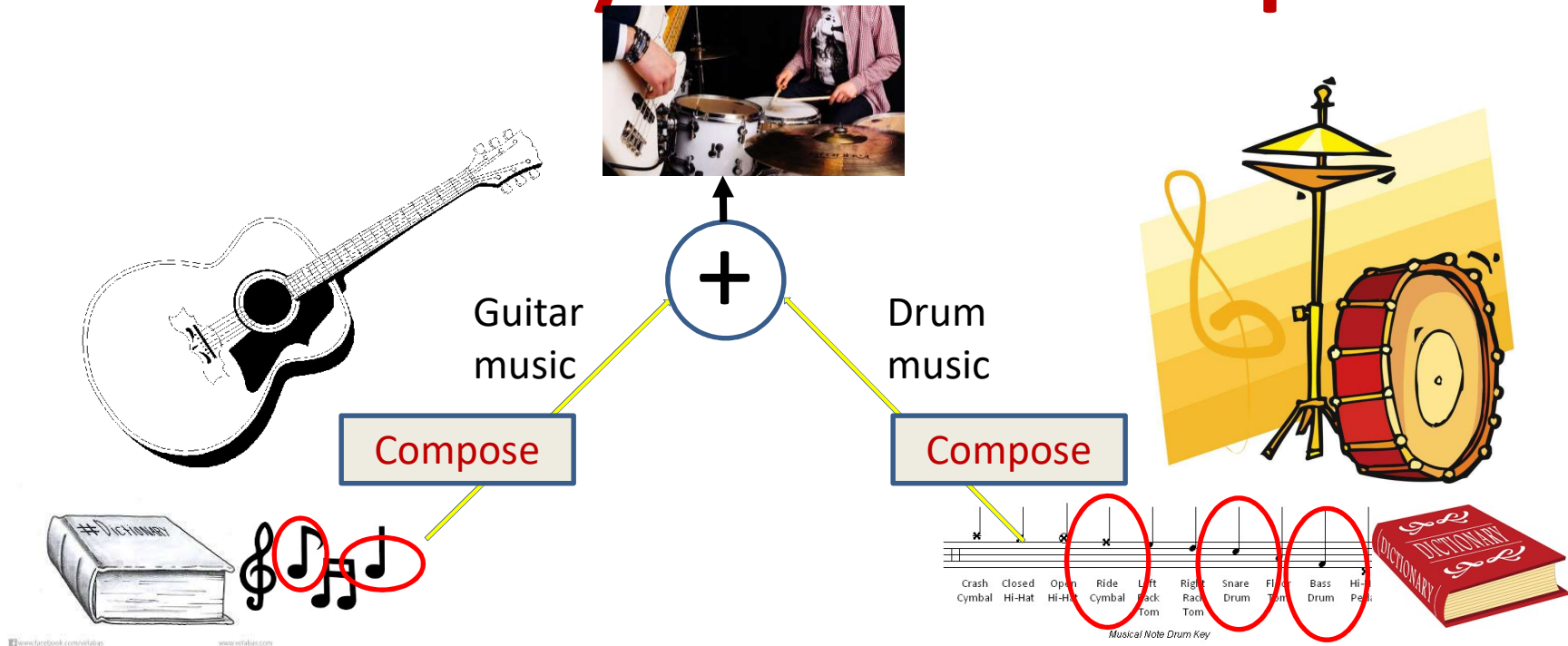

- Separation: Identify the combination of entries from both dictionaries that compose the mixed signal
  - The composition from the identified dictionary entries gives you the separated signals

# Learning Dictionaries



- Autoencoder dictionaries for each source
  - Operating on (magnitude) spectrograms
- For a well-trained network, the “decoder” dictionary is highly specialized to creating sounds for that source

# Model for mixed signal

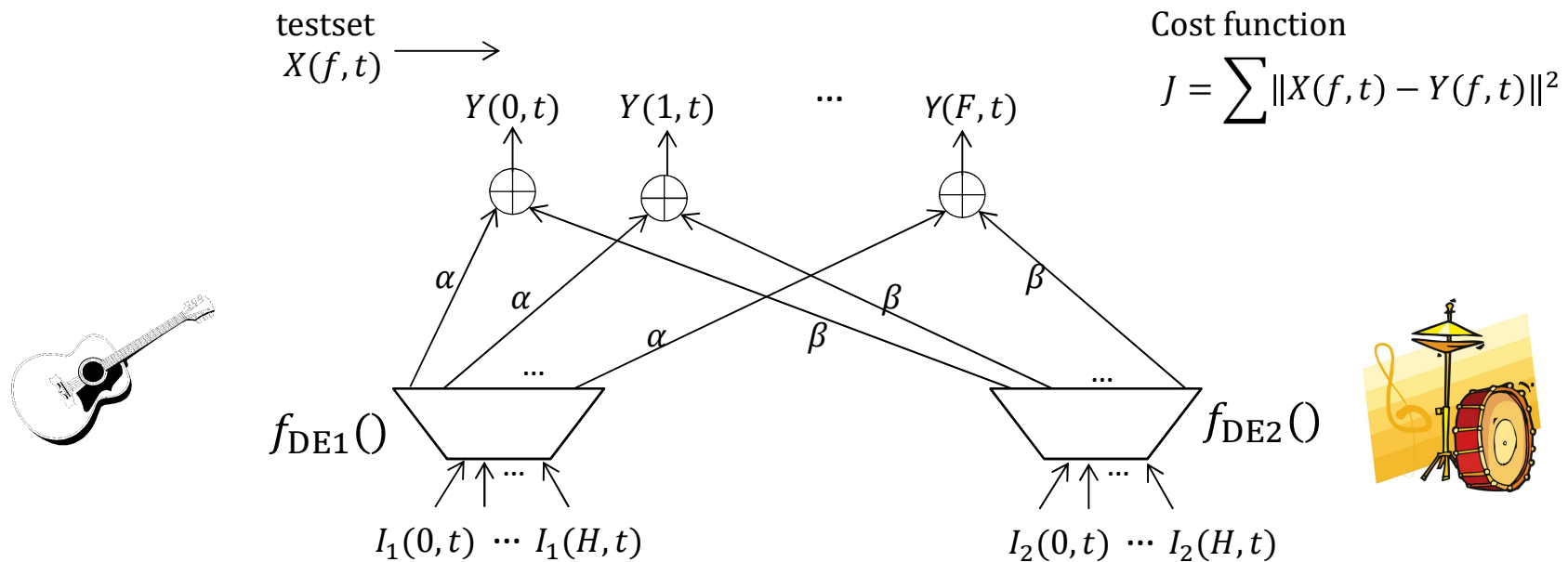

Estimate  $I_1()$  and  $I_2()$  to minimize cost function  $J()$

- The sum of the outputs of both neural dictionaries
  - For some unknown input



# Separation

Test Process

testset  
 $X(f, t)$

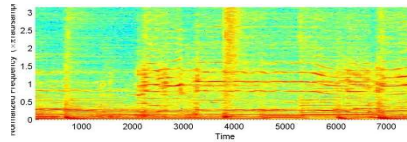

Cost function

$$J = \sum \|X(f, t) - Y(f, t)\|^2$$

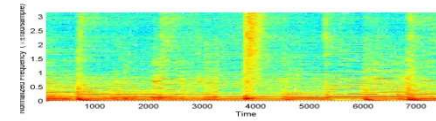
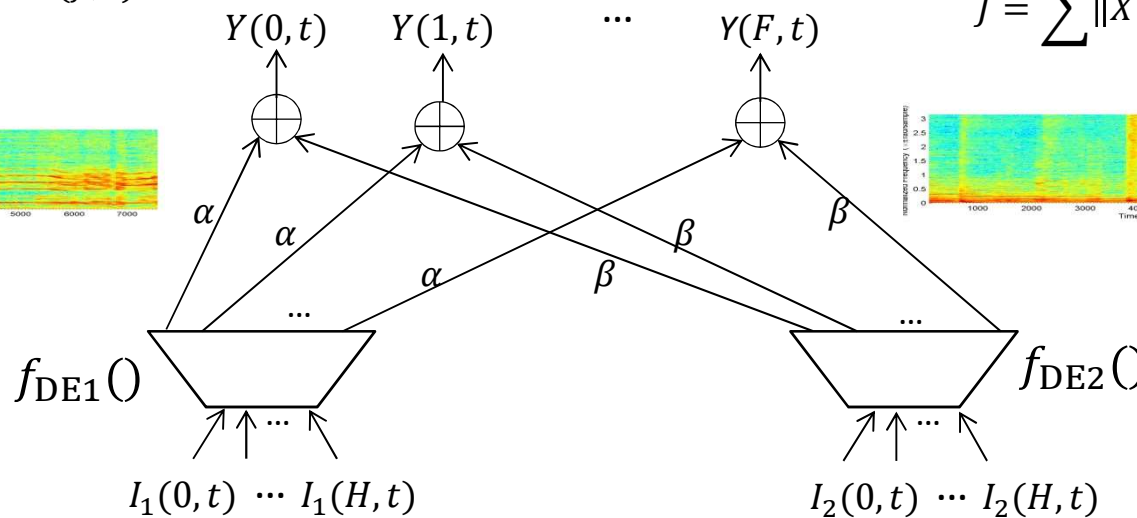
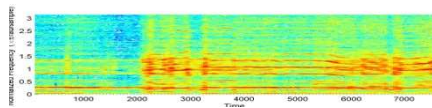

$H$  : Hidden layer size

Estimate  $I_1()$  and  $I_2()$  to minimize cost function  $J()$

- Given mixed signal and source dictionaries, find excitation that best recreates mixed signal
  - Simple backpropagation
- Intermediate results are separated signals

# Example Results

Mixture



Separated



Original

Separated



Original

5-layer dictionary, 600 units wide

- Separating music

# Story for the day

- Classification networks learn to predict the *a posteriori* probabilities of classes
  - The network until the final layer is a feature extractor that converts the input data to be (almost) linearly separable
  - The final layer is a classifier/predictor that operates on linearly separable data
- Neural networks can be used to perform linear or non-linear PCA
  - “Autoencoders”
  - Can also be used to compose constructive dictionaries for data
    - Which, in turn can be used to model data distributions