

*16-782 Fall'23*

*Planning & Decision-making in Robotics*

*Introduction;*

*What is Planning, Role of Planning in Robots*

*Maxim Likhachev*

*Robotics Institute*

*Carnegie Mellon University*

# Class Logistics

---

- Instructor:

Maxim Likhachev – [maxim@cs.cmu.edu](mailto:maxim@cs.cmu.edu)

- TA:

Abigail Breitfeld - [abreitfe@andrew.cmu.edu](mailto:abreitfe@andrew.cmu.edu)

Tejus Gupta – [tejusg@andrew.cmu.edu](mailto:tejusg@andrew.cmu.edu)

- Website:

[http://www.cs.cmu.edu/~maxim/classes/robotplanning\\_grad](http://www.cs.cmu.edu/~maxim/classes/robotplanning_grad)

- Announcements, Questions, Recorded Lectures:

- on Piazza

- should have received an email with access info

# About Me

- My Research Interests:
  - Planning, Decision-making, Learning
  - Applications: planning for complex robotic systems including aerial and ground robots, manipulation platforms, small teams of heterogeneous robots
- More info: <http://www.cs.cmu.edu/~maxim>
- Search-based Planning Lab: <http://www.sbpl.net>

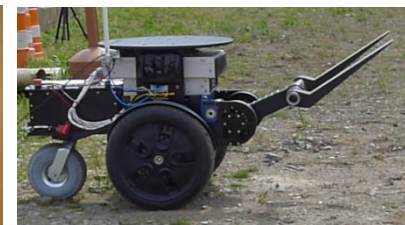

# About Me

---

- Also, currently split between CMU and [Waymo](#), where I'm heavily involved in planning for self-driving vehicles

# Class Objectives at High-level

---

- Understand and learn how to implement most popular planning and decision-making approaches in robotics
- Understand the challenges and basic approaches to interleaving planning and execution in robotic systems
- Learn common uses of planning/decision-making in robotics
- Get a sense for doing research in the area of planning/decision-making in robotics

# What is Planning?

---

- According to Wikipedia: *“Planning is the process of thinking about an organizing the activities required to achieve a desired goal.”*

# What is Planning for Robotics?

- According to Wikipedia: *“Planning is the process of thinking about an organizing the activities required to achieve a desired goal.”*

- **Given**

- model (states and actions) of the robot(s)  $M^R = \langle S^R, A^R \rangle$
- a model of the world  $M^W$
- current state of the robot  $s_{current}^R$
- current state of the world  $s_{current}^W$
- cost function  $C$  of robot actions
- desired set of states for robot and world  $G$

- **Compute a plan  $\pi$  that**

- prescribes a set of actions  $a_1, \dots, a_K$  in  $A^R$  the robot should execute
- reaches one of the desired states in  $G$
- (preferably) minimizes the cumulative cost of executing actions  $a_1, \dots, a_K$

# Few Examples

- **Given**

- model (states and actions) of the robot(s)  $M^R = \langle S^R, A^R \rangle$
- a model of the world  $M^W$
- current state of the robot  $s_{current}^R$
- current state of the world  $s_{current}^W$
- cost function  $C$  of robot actions
- desired set of states for robot and world  $G$

- **Compute a plan  $\pi$  that**

- prescribes a set of actions  $a_1, \dots, a_K$  in  $A^R$  the robot should execute
- reaches one of the desired states in  $G$
- (preferably) minimizes the cumulative cost of executing actions  $a_1, \dots, a_K$

Planning for omnidirectional robot:

What is  $M^R$ ?

What is  $M^W$ ?

What is  $s_{current}^R$ ?

What is  $s_{current}^W$ ?

What is  $C$ ?

What is  $G$ ?

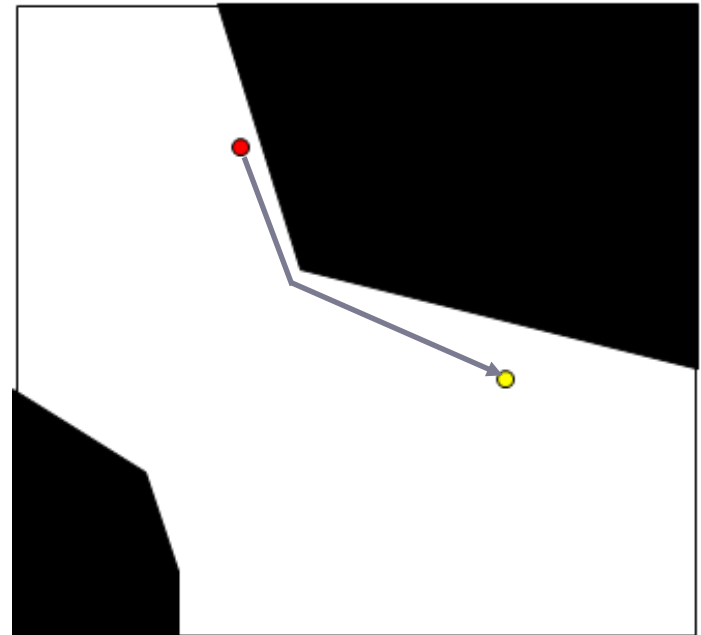



# Few Examples

- **Given**

- model (states and actions) of the robot(s)  $M^R = \langle S^R, A^R \rangle$
- a model of the world  $M^W$
- current state of the robot  $s_{current}^R$
- current state of the world  $s_{current}^W$
- cost function  $C$  of robot actions
- desired set of states for robot and world  $G$

- **Compute a plan  $\pi$  that**

- prescribes a set of actions  $a_1, \dots, a_K$  in  $A^R$  the robot should execute
- reaches one of the desired states in  $G$
- (preferably) minimizes the cumulative cost of executing actions  $a_1, \dots, a_K$

Planning for omnidirectional drone:

*What is  $M^R$ ?*

*What is  $M^W$ ?*

*What is  $s_{current}^R$ ?*

*What is  $s_{current}^W$ ?*

*What is  $C$ ?*

*What is  $G$ ?*



MacAllister et al., 2013

# Few Examples

- **Given**

- model (states and actions) of the robot(s)  $M^R = \langle S^R, A^R \rangle$
- a model of the world  $M^W$
- current state of the robot  $s_{current}^R$
- current state of the world  $s_{current}^W$
- cost function  $C$  of robot actions
- desired set of states for robot and world  $G$

- **Compute a plan  $\pi$  that**

- prescribes a set of actions  $a_1, \dots, a_K$  in  $A^R$  the robot should execute
- reaches one of the desired states in  $G$
- (preferably) minimizes the cumulative cost of executing actions  $a_1, \dots, a_K$

Planning for autonomous navigation:

*What is  $M^R$ ?*

*What is  $M^W$ ?*

*What is  $s_{current}^R$ ?*

*What is  $s_{current}^W$ ?*

*What is  $C$ ?*

*What is  $G$ ?*

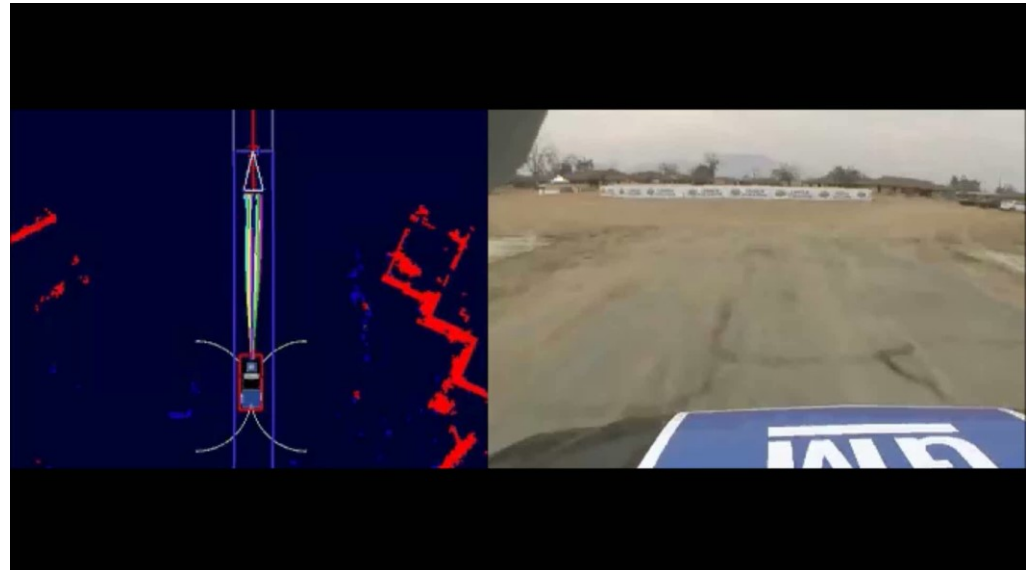

*Likhachev & Ferguson, '09; part of Tartanracing team from CMU for the Urban Challenge 2007 race*

# Few Examples

- **Given**

- model (states and actions) of the robot(s)  $M^R = \langle S^R, A^R \rangle$
- a model of the world  $M^W$
- current state of the robot  $s_{current}^R$
- current state of the world  $s_{current}^W$
- cost function  $C$  of robot actions
- desired set of states for robot and world  $G$

- **Compute a plan  $\pi$  that**

- prescribes a set of actions  $a_1, \dots, a_K$  in  $A^R$  the robot should execute
- reaches one of the desired states in  $G$
- (preferably) minimizes the cumulative cost of executing actions  $a_1, \dots, a_K$

Planning for autonomous flight among people :

Narayanan et al., 2012

What is  $M^R$ ?

What is  $M^W$ ?

What is  $s_{current}^R$ ?

What is  $s_{current}^W$ ?

What is  $C$ ?

What is  $G$ ?



# Few Examples

- **Given**

- model (states and actions) of the robot(s)  $M^R = \langle S^R, A^R \rangle$
- a model of the world  $M^W$
- current state of the robot  $s_{current}^R$
- current state of the world  $s_{current}^W$
- cost function  $C$  of robot actions
- desired set of states for robot and world  $G$

- **Compute a plan  $\pi$  that**

- prescribes a set of actions  $a_1, \dots, a_K$  in  $A^R$  the robot should execute
- reaches one of the desired states in  $G$
- (preferably) minimizes the cumulative cost of executing actions  $a_1, \dots, a_K$

Planning for a mobile manipulator robot opening a door:

Gray et al., 2013

What is  $M^R$ ?

What is  $M^W$ ?

What is  $s_{current}^R$ ?

What is  $s_{current}^W$ ?

What is  $C$ ?

What is  $G$ ?



# Few Examples

- **Given**

- model (states and actions) of the robot(s)  $M^R = \langle S^R, A^R \rangle$
- a model of the world  $M^W$
- current state of the robot  $s_{current}^R$
- current state of the world  $s_{current}^W$
- cost function  $C$  of robot actions
- desired set of states for robot and world  $G$

- **Compute a plan  $\pi$  that**

- prescribes a set of actions  $a_1, \dots, a_K$  in  $A^R$  the robot should execute
- reaches one of the desired states in  $G$
- (preferably) minimizes the cumulative cost of executing actions  $a_1, \dots, a_K$

Planning for a mobile manipulator robot assembling a birdcage: Cohen et al., 2015

What is  $M^R$ ?

What is  $M^W$ ?

What is  $s_{current}^R$ ?

What is  $s_{current}^W$ ?

What is  $C$ ?

What is  $G$ ?

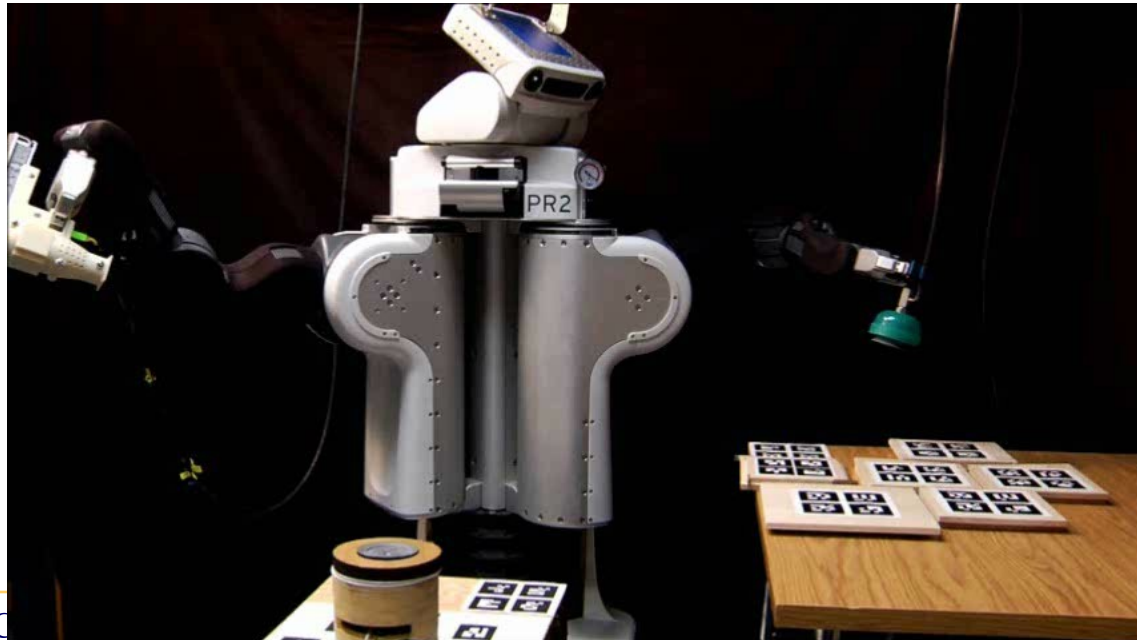



# Few Examples

- **Given**

- model (states and actions) of the robot(s)  $M^R = \langle S^R, A^R \rangle$
- a model of the world  $M^W$
- current state of the robot  $s_{current}^R$
- current state of the world  $s_{current}^W$
- cost function  $C$  of robot actions
- desired set of states for robot and world  $G$

- **Compute a plan  $\pi$  that**

- prescribes a set of actions  $a_1, \dots, a_K$  in  $A^R$  the robot should execute
- reaches one of the desired states in  $G$
- (preferably) minimizes the cumulative cost of executing actions  $a_1, \dots, a_K$

Planning/decision-making for a mobile manipulator unloading a truck:

What is  $M^R$ ?

What is  $M^W$ ?

What is  $s_{current}^R$ ?

What is  $s_{current}^W$ ?

What is  $C$ ?

What is  $G$ ?

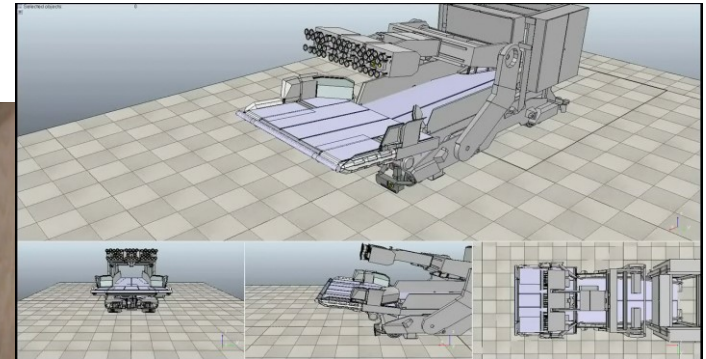

# Assuming Infinite Computational Resources...

---

*Where does Planning break?*

# Assuming Infinite Computational Resources...

*Where does Planning break?*

*Reliance on the knowledge/accuracy of the model!*

*Role of Learning in Planning?*



# Planning vs. Learning

## *Model-based approach*

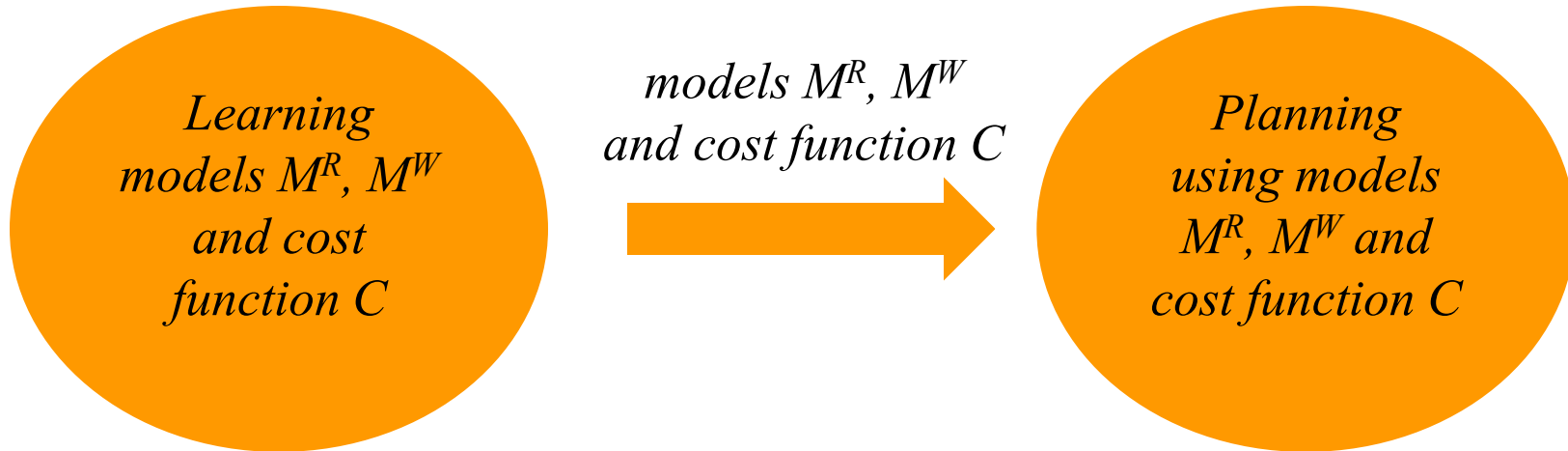

## *Model-free approach*

*Learning the mapping from “what robot sees” onto “what to do next” using rewards received by the robot (Reinforcement Learning) or demonstrations (Behavior Cloning)*

# Planning within a Typical Autonomy Architecture

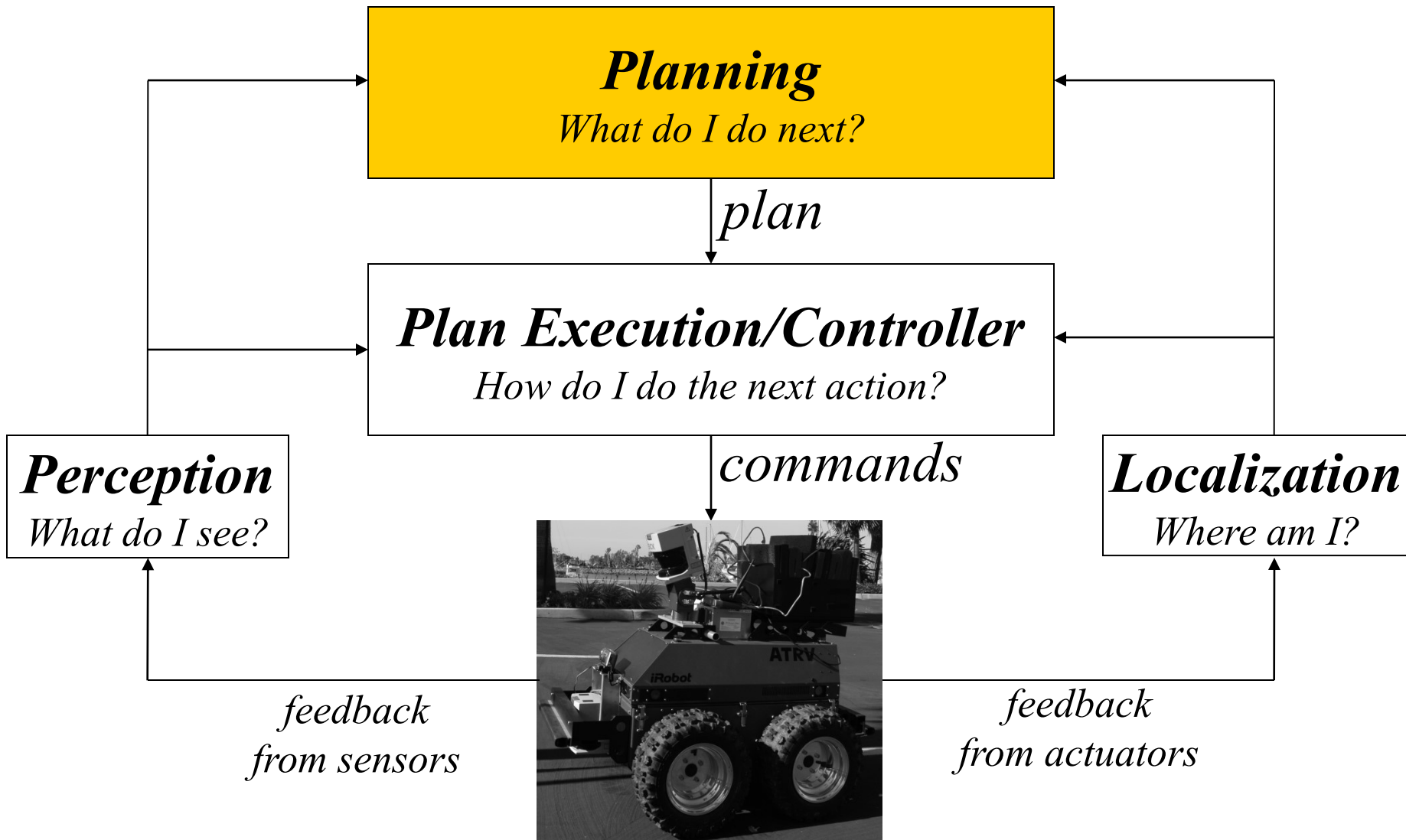

# Planning vs. Trajectory Following vs. Control

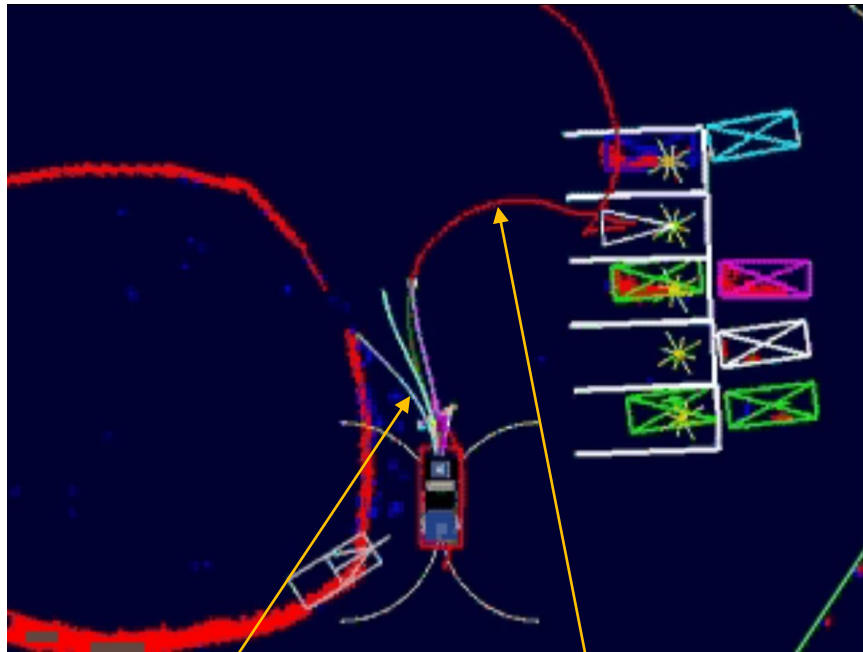

*local planning  
(trajectory following)*

*global planning*

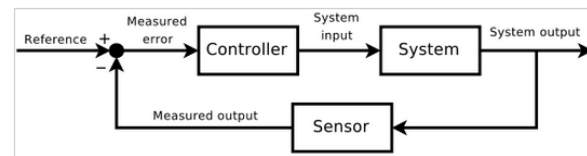

*controller*

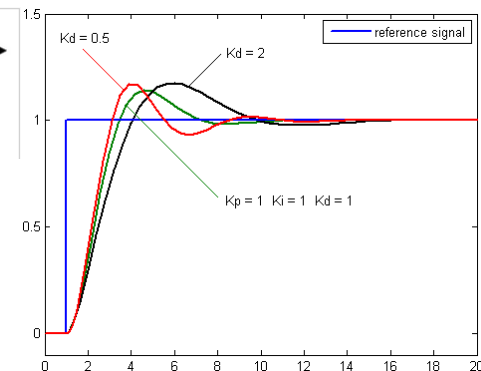

*Images from wikipedia*

# Class Logistics

- Books (optional):
  - Planning Algorithms *by Steven M. LaValle*
  - Heuristic Search, Theory and Applications *by Stefan Edelkamp and Stefan Schroedl*
  - Principles of Robot Motion, Theory, Algorithms, and Implementations *by Howie Choset, Kevin M. Lynch, Seth Hutchinson, George A. Kantor, Wolfram Burgard, Lydia E. Kavraki and Sebastian Thrun*
  - Artificial Intelligence: A Modern Approach *by Stuart Russell and Peter Norvig*

# Class Prerequisites

---

- Knowledge of programming (e.g., C, C++)
- Working knowledge of data structures & basic Computer Science algorithms (e.g., graphs, linked lists, priority queues, BFS/DFS, etc.)
- Prior exposure to robotics

# Class Objectives

- Understand and learn how to implement most popular planning algorithms in robotics including heuristic search-based planning algorithms, sampling-based planning algorithms, task planning, planning under uncertainty and multi-robot planning
- Learn basic principles behind the design of planning representations
- Understand core theoretical principles that many planning algorithms rely on and learn how to analyze theoretical properties of the algorithms
- Understand the challenges and basic approaches to interleaving planning and execution in robotic systems
- Learn common uses of planning in robotics
- Get a sense for doing research in the area of planning/decision-making in robotics

# Tentative Class Schedule

<i>TENTATIVE SCHEDULE FOR Planning and Decision-making in Robotics CLASS</i>				
<i>Fall 2023</i>				
Date	Day	Topic	HW out	HW due
28-Aug	Mon	Introduction; What is Planning?		
30-Aug	Wed	planning representations: explicit vs. implicit graphs, skeletonization, cell decomposition & lattice-based graphs		
4-Sep	Mon	LABOR DAY - NO CLASS		
6-Sep	Wed	search algorithms: A*, Multi-goal A*, Weighted A*, Backward A*	HW1	
11-Sep	Mon	search algorithms: Heuristic functions, Multi-Heuristic A*		
13-Sep	Wed	interleaving planning and execution: Anytime heuristic search, Incremental heuristic search		
18-Sep	Mon	interleaving planning and execution: Real-time heuristic Search		
20-Sep	Wed	case study: planning for autonomous driving		
25-Sep	Mon	planning representations: PRM for continuous spaces		HW1
27-Sep	Wed	planning representations/search algorithms: RRT, RRT-Connect, RRT*	HW2	
2-Oct	Mon	case study: planning for mobile manipulators and legged robots		
4-Oct	Wed	search algorithms: Markov Property, dependent vs. independent variables, Dominance		
9-Oct	Mon	case study: planning for coverage, mapping and surveillance tasks		
11-Oct	Wed	planning representations: state-space vs. symbolic representation for task planning		HW2
16-Oct	Mon	FALL BREAK - NO CLASS		
18-Oct	Wed	FALL BREAK - NO CLASS		
23-Oct	Mon	search algorithms: planning on symbolic representations	HW3	
25-Oct	Wed	planning under uncertainty: Minimax formulation, Minimax Backward A*		
30-Oct	Mon	planning under uncertainty: Markov Decision Processes, Value Iteration, RTDP		
1-Nov	Wed	final project proposal presentations		
6-Nov	Mon	planning under uncertainty: Markov Decision Processes, Value Iteration, RTDP (cont'd)		HW3
8-Nov	Wed	planning under uncertainty: Partially-Observable Markov Decision Processes		
13-Nov	Mon	planning under uncertainty: Partially-Observable Markov Decision Processes (cont'd)		
15-Nov	Wed	exam		
20-Nov	Mon	TBD		
22-Nov	Wed	THANKSGIVING - NO CLASS		
27-Nov	Mon	multi-robot planning		
29-Nov	Wed	multi-robot planning (cont'd)		
4-Dec	Mon	learning in planning		
6-Dec	Wed	final project presentations		

# Three Homeworks + Final Project

- All homeworks are individual (no groups)
- Final projects is a group project (3-5 people per group)
- Homeworks are programming assignments based on the material
- Final project is a research-like project
  - For example: to develop and implement a planner for a robot planning problem of your choice
  - Or: to extend a particular planning algorithm to improve its running time or to handle additional conditions
  - Two presentations (proposal and final) and meetings with groups



# Class Structure

- Grading

Three homeworks	33%
Exam	20%
In-class pop quizzes	10%
Final project	32%
Participation	5%

- Exam is tentatively scheduled for Nov. 15
- Late Policy
  - 3 free late days
  - No late days may be used for the final project!
  - Each additional late day will incur a 10% penalty

---

Questions about the class?