



10-423/10-623 Generative AI

Machine Learning Department
School of Computer Science
Carnegie Mellon University

Video Generation and Understanding

Matt Gormley & Henry Chai

Lecture 25

Dec. 4, 2024

Reminders

- **HW623**
 - Only for students registered in 10-623
 - Due: Mon, Dec 2 at 11:59pm
 - Submit form: <https://forms.gle/azrmUR9KrFexnASi7>
- **Project Poster**
 - Upload Due: Tue, Dec 10 at 11:59pm
 - Presentations: Fri, Dec 13 at 1pm-4pm
- **Project Final Report**
 - Due: Fri, Dec 13 at 11:59pm
- **Project Code Upload**
 - Due: Fri, Dec 13 at 11:59pm

Video Generation and Understanding

- Outline

- video generation (video diffusion models)

- 3D Unet (2016)
 - VViT & Spatio-Temporal Attention (2021)
 - **Video Diffusion Model** (2022)
 - **Video Latent Diffusion Model** (2023)
 - Diffusion Transformer (2023)
 - **Sora** (2024)

- video understanding (visual language models)

- ~~• Llava (understand text+image)~~
 - ~~• Video-Llava (understand text+image+video)~~
 - ~~• QwenVL (understand text+image+video)~~
 - **Large World Model** (generate/understand text+image+video)

VIDEO DIFFUSION MODELS

Datasets for Video Models

Dataset	Year	Text	Domain	#Clips	Resolution
MSR-VTT [271]	2016	Manual	Open	10 K	240P
DideMo [3]	2017	Manual	Flickr	27 K	–
LSMDC [192]	2017	Manual	Movie	118 K	1080P
ActivityNet [119]	2017	Manual	Action	100 K	–
YouCook2 [307]	2018	Manual	Cooking	14 K	–
How2 [202]	2018	Manual	Instruct	80 K	–
VATEX [245]	2019	Manual	Action	41 K	240P
HowTo100M [162]	2019	ASR	Instruct	136 M	240P
WTS70M [217]	2020	Metadata	Action	70 M	–
YT-Temporal [290]	2021	ASR	Open	180 M	–
WebVid10M [5]	2021	Alt-text	Open	10.7 M	360P
Echo-Dynamic [191]	2021	Manual	Echocardiogram	10 K	–
Tiktok [241]	2021	Manual	Action	0.3 K	–
HD-VILA [273]	2022	ASR	Open	103 M	720P
VideoCC3M [167]	2022	Transfer	Open	10.3 M	–
HD-VG-130M [244]	2023	Generated	Open	130 M	720P
InternVid [250]	2023	Generated	Open	234 M	720P
CelebV-Text [286]	2023	Generated	Face	70 K	480P
Panda-70M [28]	2024	Generated	Open	70.8 M	720P

Datasets for Video Models

- The largest datasets of videos with captions use a model to generate the captions
- The quality and style of the captions can vary wildly depending on which model is used



Figure 1. Comparison of Panda-70M to the existing large-scale video-language datasets. We introduce Panda-70M, a large-scale video dataset with captions that are annotated by multiple cross-modality vision-language models. Compared to text annotations in existing dataset [80], captions in Panda-70M more precisely describe the main object and action in videos (highlighted in green). Besides, videos in Panda-70M are semantically coherent, high-resolution, and free from watermarks. More samples can be found in Appendix E.

Panda-70M Examples: <https://snap-research.github.io/Panda-70M/>

Video Diffusion Model

- Architecture = 3D UNet + spatial-temporal attention
- Relative positional embeddings across time axis

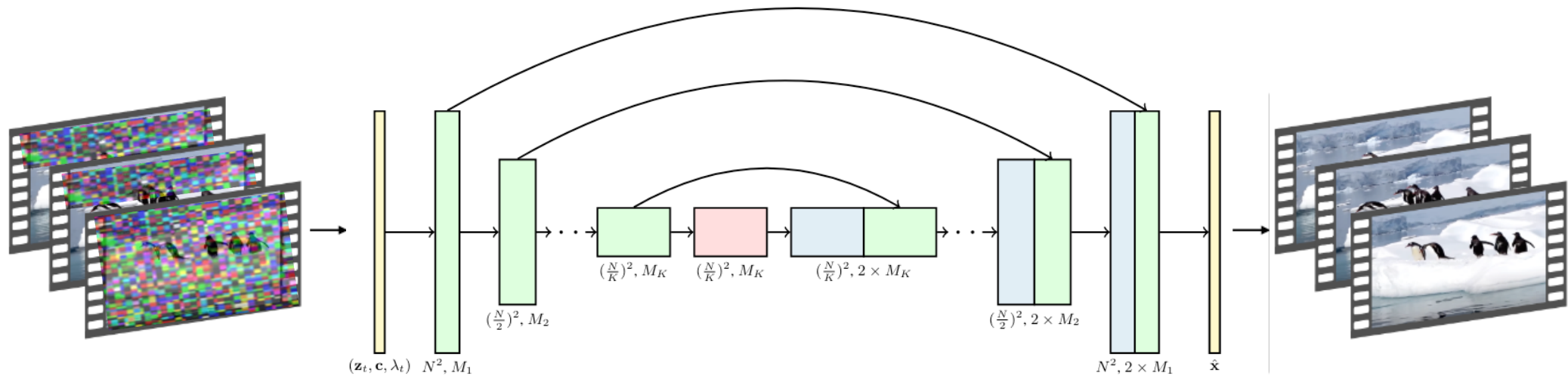
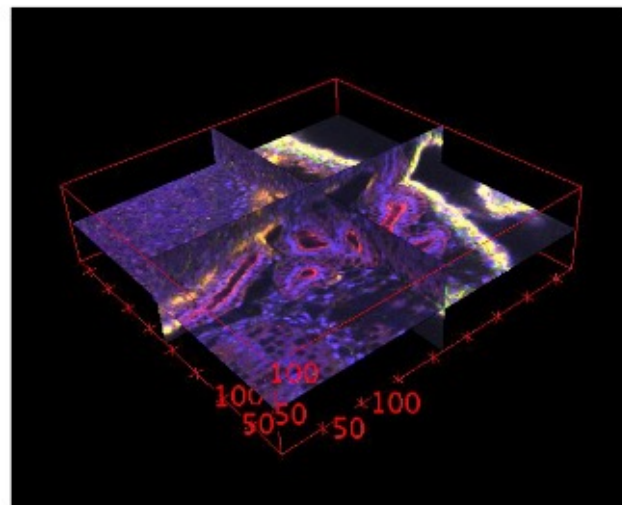

Figure 1: The 3D U-Net architecture for \hat{x}_θ in the diffusion model. Each block represents a 4D tensor with axes labeled as frames \times height \times width \times channels, processed in a space-time factorized manner as described in Section 3. The input is a noisy video \mathbf{z}_t , conditioning \mathbf{c} , and the log SNR λ_t . The downsampling/upsampling blocks adjust the spatial input resolution height \times width by a factor of 2 through each of the K blocks. The channel counts are specified using channel multipliers M_1, M_2, \dots, M_K , and the upsampling pass has concatenation skip connections to the downsampling pass.

3D UNet

- Suppose you want to do image segmentation on 3D images (e.g. high-resolution, 3D imaging of a *Xenopus* kidney)
- The 3D UNet model is almost identical to the standard UNet except that it replaces 2D convolution (height, width, channel) with 3D convolution (height, width, **depth**, channel)



raw image

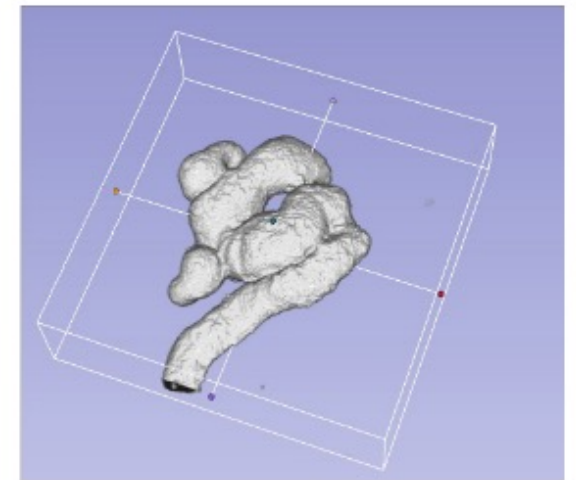
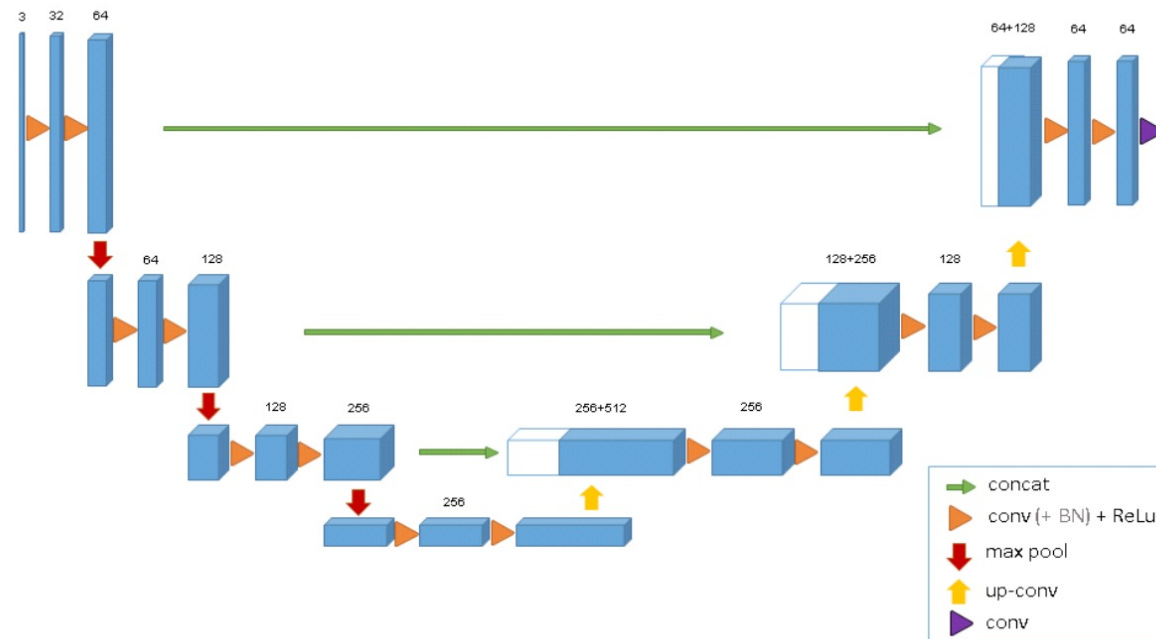

dense segmentation

Video Vision Transformer (VViT)

- The Video ViT takes a series of image frames from a video as input
- A standard ViT model for images would treat each frame as independent (i.e. only has spatial attention across the $[w,h]$ axes)
- The Video ViT instead includes two types of attention: spatial attention and temporal attention

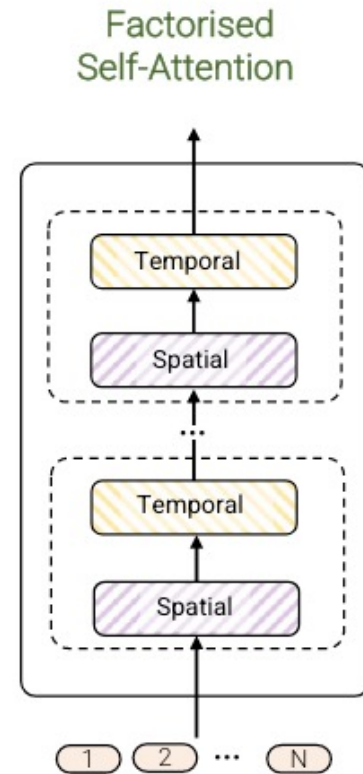
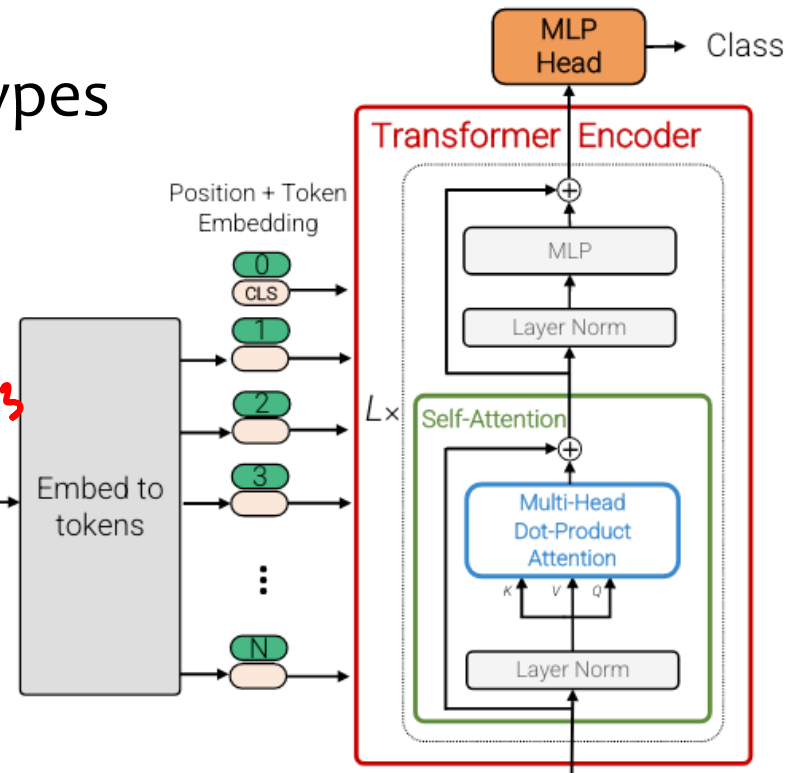
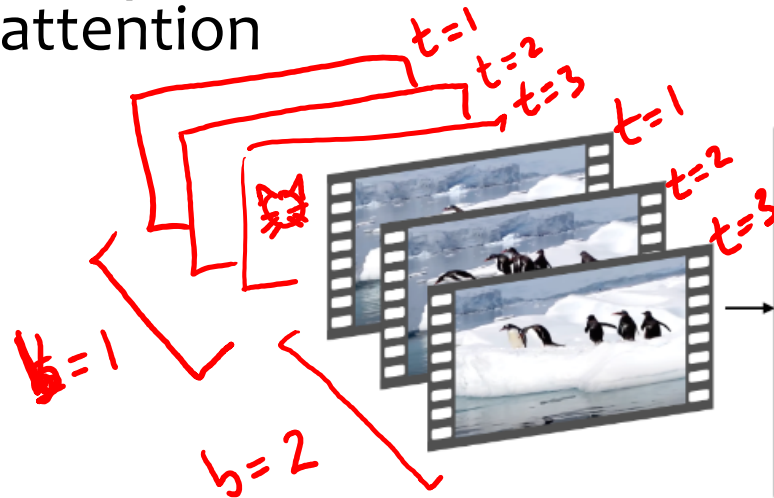

Factorized Spatial-Temporal Attention

VViT alternate between the two types:

Spatial attention:

1. reshape: $b \ t \ h \ w \ c \rightarrow (b \ t) \ (h \ w) \ c$
2. multi-headed attention
3. reshape: $(b \ t) \ (h \ w) \ c \rightarrow b \ t \ h \ w \ c$

Temporal attention:

1. reshape: $b \ t \ h \ w \ c \rightarrow (b \ h \ w) \ t \ c$
2. multi-headed attention
3. reshape: $(b \ h \ w) \ t \ c \rightarrow b \ t \ c \ h \ w$

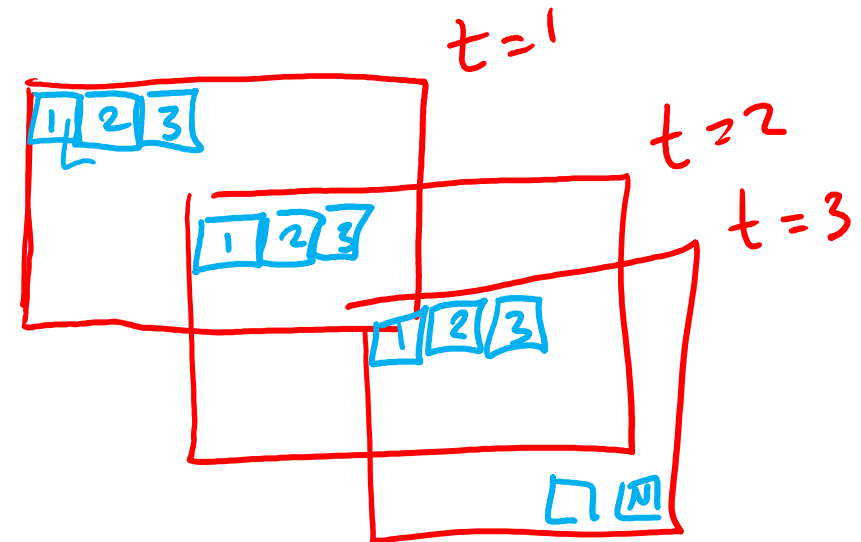
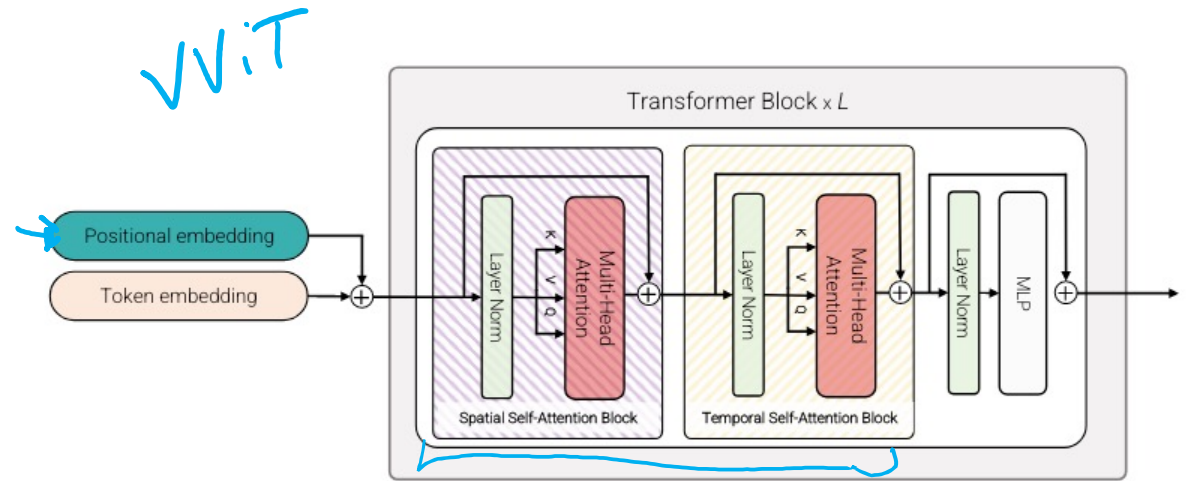

Video Diffusion Model

- Architecture = 3D UNet + spatial-temporal attention
- Relative positional embeddings across time axis

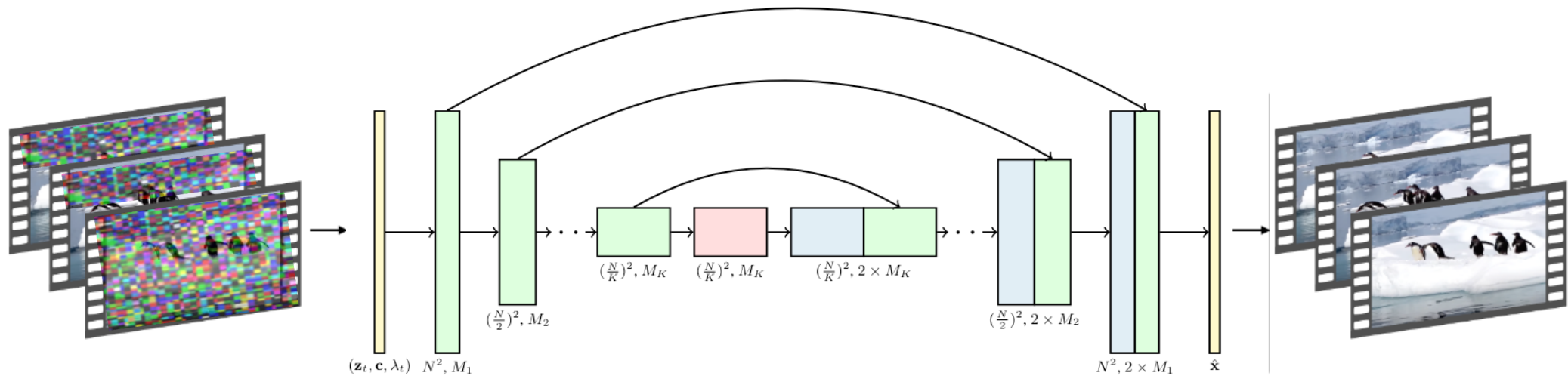

Figure 1: The 3D U-Net architecture for $\hat{\mathbf{x}}_\theta$ in the diffusion model. Each block represents a 4D tensor with axes labeled as frames \times height \times width \times channels, processed in a space-time factorized manner as described in Section 3. The input is a noisy video \mathbf{z}_t , conditioning \mathbf{c} , and the log SNR λ_t . The downsampling/upsampling blocks adjust the spatial input resolution height \times width by a factor of 2 through each of the K blocks. The channel counts are specified using channel multipliers M_1, M_2, \dots, M_K , and the upsampling pass has concatenation skip connections to the downsampling pass.

Video Diffusion Model

Figure from <http://arxiv.org/abs/2304.08818>

- The model can be **jointly** trained on **images and video**
- When trained on images, the temporal attention is **masked** so that all the attention mass is placed on the current batch element
- Such training improves performance on video generation

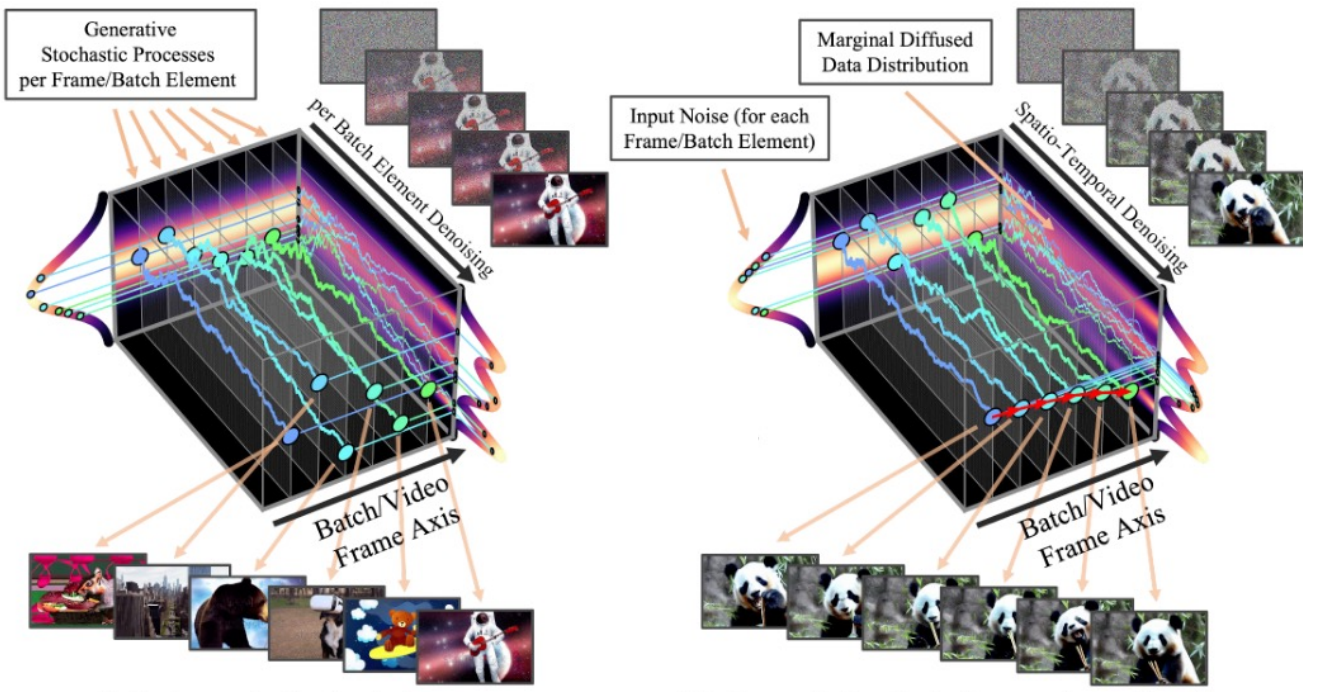

Image frames	FVD↓	FID-avg↓	IS-avg↑	FID-first↓	IS-first↑
0	202.28/205.42	37.52/37.40	7.91/7.58	41.14/40.87	9.23/8.74
4	68.11/70.74	18.62/18.42	9.02/8.53	22.54/22.19	10.58/9.91
8	57.84/60.72	15.57/15.44	9.32/8.82	19.25/18.98	10.81/10.12

Video Diffusion Model

- **Classifier-free Guidance**

$$\tilde{\epsilon}_{\theta}(\mathbf{z}_t, \mathbf{c}) = (1 + w)\epsilon_{\theta}(\mathbf{z}_t, \mathbf{c}) - w\epsilon_{\theta}(\mathbf{z}_t),$$

- Suppose we want to sample from a conditional distribution: $p_{\theta}(\mathbf{x}^b | \mathbf{x}^a)$.
 - \mathbf{x}^a could be the first 16 frames, and now we want to generate the next 16 frames \mathbf{x}^b
 - or \mathbf{x}^a could be a low frame rate video and \mathbf{x}^b are the frames in between to increase framerate

- **Reconstruction Guided Sampling**

- key idea: guide the sample “based on the model’s reconstruction of the conditioning data”

$$\hat{\mathbf{x}}_{\theta}(\mathbf{z}_t) = [\hat{\mathbf{x}}_{\theta}^a(\mathbf{z}_t), \hat{\mathbf{x}}_{\theta}^b(\mathbf{z}_t)] \quad \mathbf{z}_t = [\mathbf{z}_t^a, \mathbf{z}_t^b]$$

$$\tilde{\mathbf{x}}_{\theta}^b(\mathbf{z}_t) = \hat{\mathbf{x}}_{\theta}^b(\mathbf{z}_t) - \frac{w_r \alpha_t}{2} \nabla_{\mathbf{z}_t^b} \|\mathbf{x}^a - \hat{\mathbf{x}}_{\theta}^a(\mathbf{z}_t)\|_2^2$$

Video Diffusion Model

- **Reconstruction Guided Sampling**

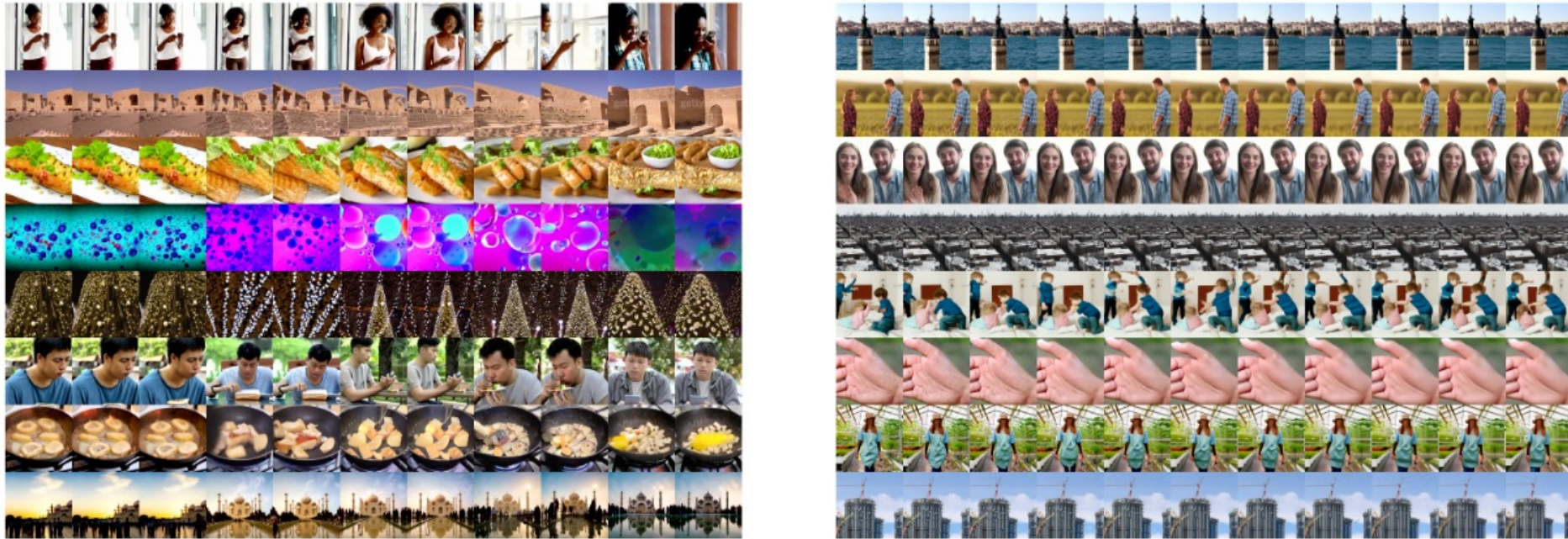

Figure 4: Comparing the replacement method (left) vs the reconstruction guidance method (right) for conditioning for block-autoregressive generation of 64 frames from a 16 frame model. Video frames are displayed over time from left to right; each row is an independent sample. The replacement method suffers from a lack of temporal coherence, unlike the reconstruction guidance method.

Video Diffusion Model

Results

- In video prediction, we are given the beginning of a video and we see how well the model can complete it

Table 2: Video prediction on BAIR Robot Pushing.

Method	FVD↓
DVD-GAN [14]	109.8
VideoGPT [62]	103.3
TrIVD-GAN-FP [33]	103.3
Transframer [35]	100
CCVS [31]	99
VideoTransformer [59]	94
FitVid [4]	93.6
NUWA [61]	86.9
<hr/>	
Video Diffusion (ours)	
ancestral sampler, 512 steps	68.19
Langevin sampler, 256 steps	66.92

Table 3: Video prediction on Kinetics-600.

Method	FVD↓	IS↑
Video Transformer [59]	170 ± 5	
DVD-GAN-FP [14]	69.1 ± 0.78	
Video VQ-VAE [57]	64.3 ± 2.04	
CCVS [31]	55 ± 1	
TrIVD-GAN-FP [33]	25.74 ± 0.66	12.54
Transframer [35]	25.4	
<hr/>		
Video Diffusion (ours)		
ancestral, 256 steps	18.6	15.39
Langevin, 128 steps	16.2 ± 0.34	15.64

Video Diffusion Model

Results

- In video prediction, we are given the beginning of a video and we see how well the model can complete it

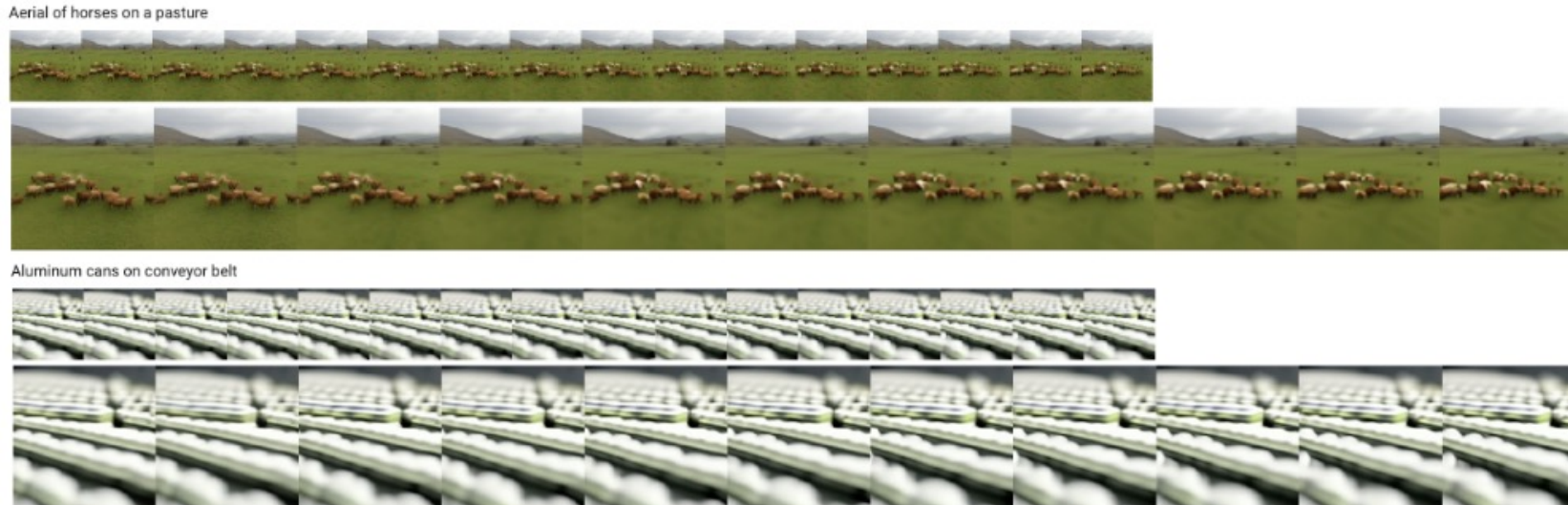

Figure 2: Text-conditioned video samples from a cascade of two models. First samples are generated from a 16x64x64 frameskip 4 model. Then those samples are treated as ground truth for simultaneous super-resolution and autoregressive extension to 64x128x128 using a 9x128x128 frameskip 1 model. Both models are conditioned on the text prompt. In this figure, the text prompt, low resolution frames, and high resolution frames are visualized in sequence. See Fig. 5 for more samples.

Video Diffusion Model

- Demo: <https://video-diffusion.github.io/>

Video Latent Diffusion Model (VLDM)

- The VLDM model combines two pieces:
 - Encoder/Decoder trained to reconstruct convert videos down to a latent representation and then reconstruct them
 - A video diffusion model trained to work in the latent space

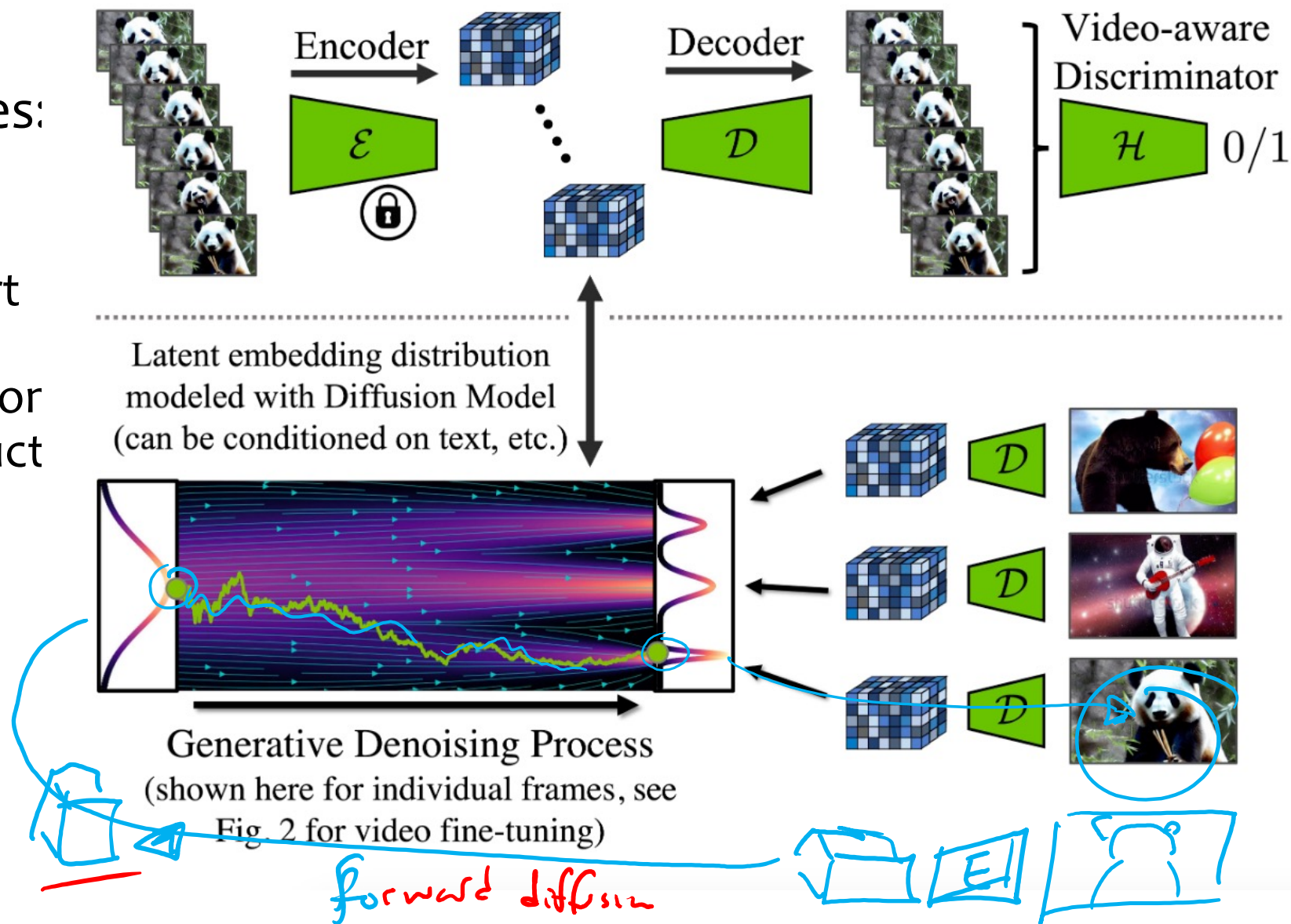

Video Latent Diffusion Model (VLDM)

- The VLDM model combines two pieces:
 - Encoder/Decoder trained to reconstruct convert videos down to a latent representation and then reconstruct them
 - A video diffusion model trained to work in the latent space

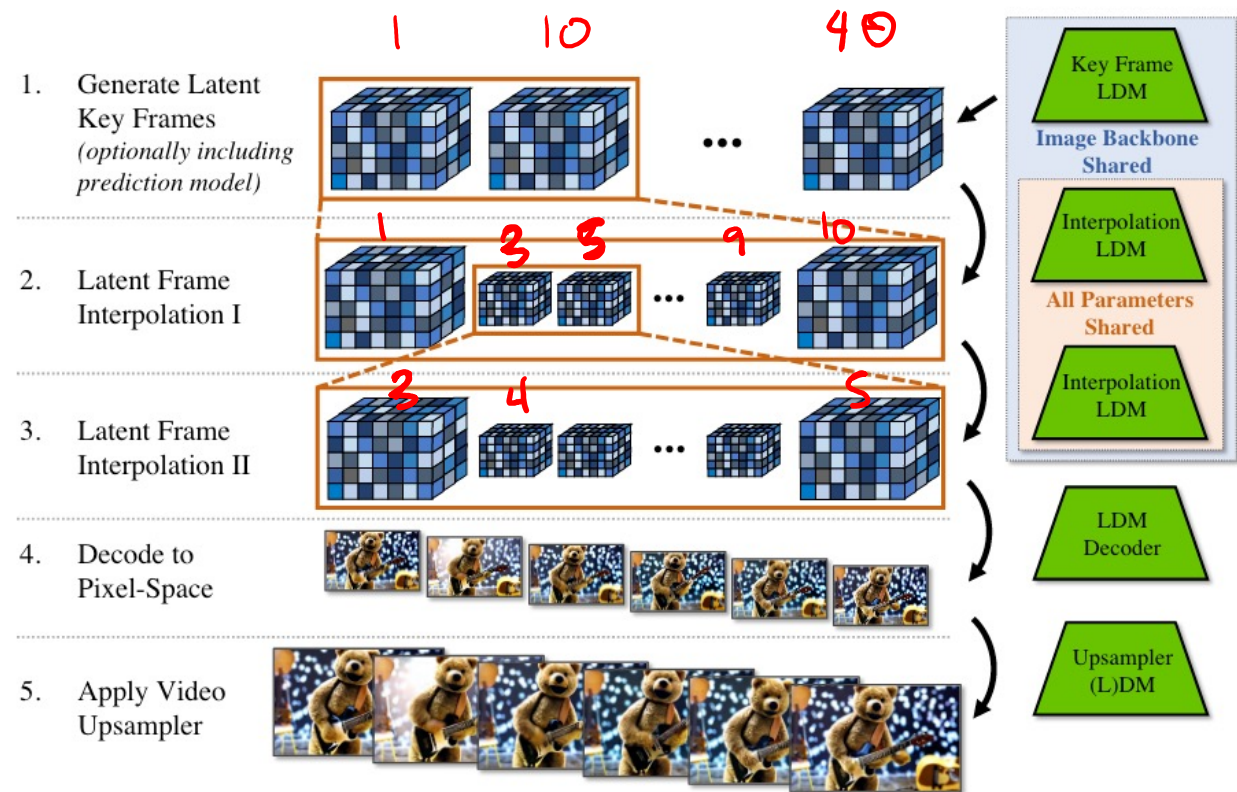

Figure 5. **Video LDM Stack.** We first generate sparse key frames. Then we temporally interpolate in two steps with the same interpolation model to achieve high frame rates. These operations are all based on latent diffusion models (LDMs) that share the same image backbone. Finally, the latent video is decoded to pixel space and optionally a video upsampler diffusion model is applied.

Video Latent Diffusion Model (VLDM)

- Demo: <https://research.nvidia.com/labs/toronto-ai/VideoLDM/>

Diffusion Transformer

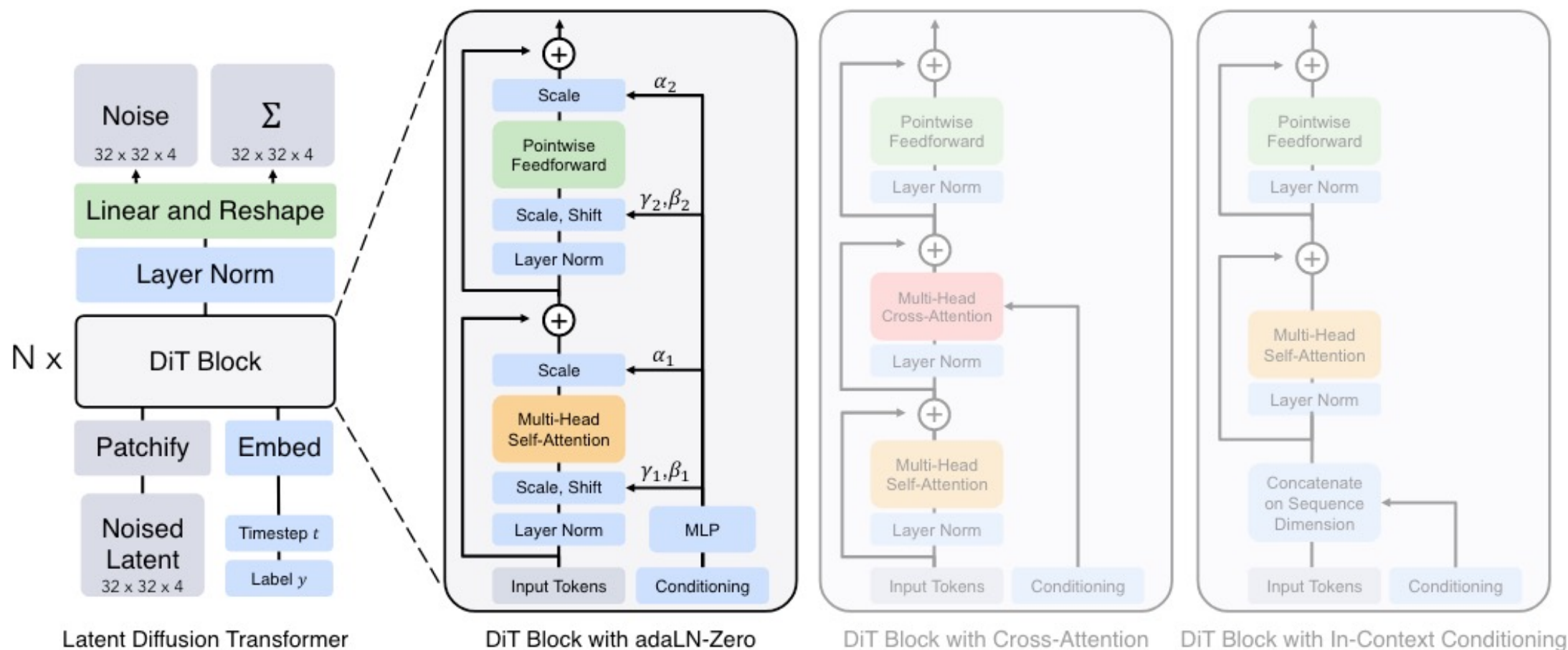

Figure 3. **The Diffusion Transformer (DiT) architecture.** *Left:* We train conditional latent DiT models. The input latent is decomposed into patches and processed by several DiT blocks. *Right:* Details of our DiT blocks. We experiment with variants of standard transformer blocks that incorporate conditioning via adaptive layer norm, cross-attention and extra input tokens. Adaptive layer norm works best.

Diffusion Transformer



Figure 1. **Diffusion models with transformer backbones achieve state-of-the-art image quality.** We show selected samples from two of our class-conditional DiT-XL/2 models trained on ImageNet at 512×512 and 256×256 resolution, respectively.

Sora

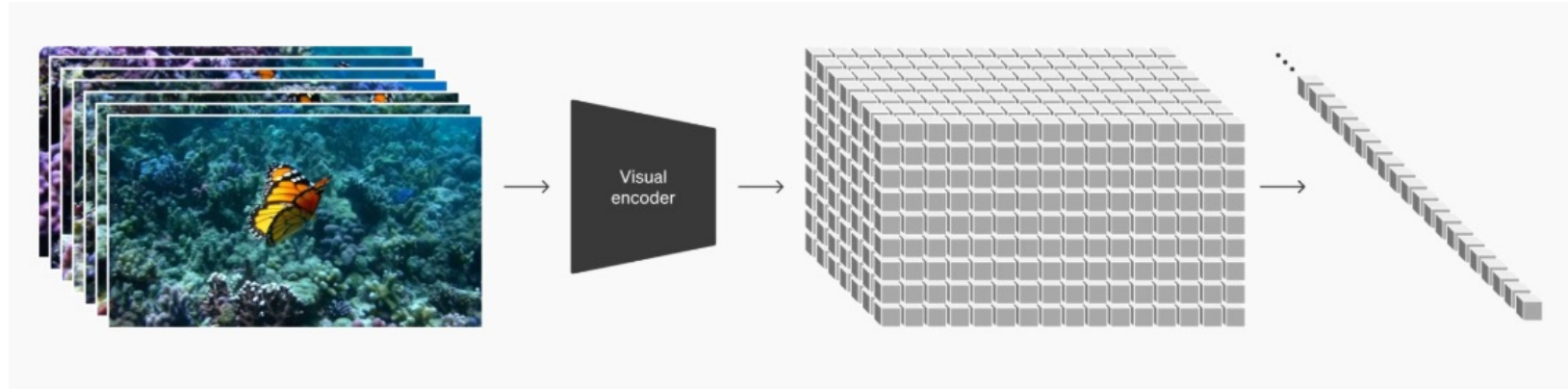

Sora uses a Diffusion Transformer backbone trained on images and videos



VIDEO AND VLMS

Large World Model



Large World Model

Stage 1: LLM Context Extension → Stage 2: Vision-Language Training

Text: Books3
 Doc Length
 10k - 100k
 Context: 32k
 Tokens: 7B
 Examples: 78K

Images: LAION-2B-en + COYO700M



Brown Dog Camo Hoodie Rootbeer float Popsicles Rose petals in a heart shape

Context: 1K
 Tokens: 400B
 Examples: 1B

Text-Vision Data (495B Tokens)

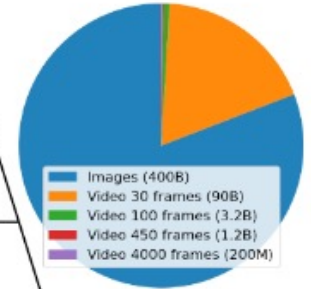

Text: Books3
 Doc Length
 100k - 200k
 Context: 128k
 Tokens: 12B
 Examples: 92K

Video (30 frames): Webvid10M + InternVid10M (3M Subset)



t = 0s Billiards, concentrated young woman playing in club. t = 8s

Context: 8k
 Tokens: 90B
 Examples: 13M

Text Data (33B Tokens)

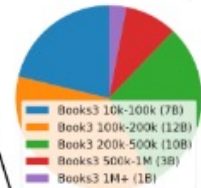

Text: Books3
 Doc Length
 200k - 500k
 Context: 256k
 Tokens: 10B
 Examples: 37K

Video (100 frames): Valley-Instruct-73k + Video-Instruct 100k



t = 0s **User:** What is happening in the video? **Assistant:** A woman is dealing cards and chips at a black jack table... t = 24s

Context: 32k
 Tokens: 3.2B
 Examples: 173K

Text: Books3
 Doc Length
 500k - 1M
 Context: 512k
 Tokens: 3B
 Examples: 3.5K

Video (450 frames): Valley-Instruct-73k + Video-Instruct 100k



t = 0s **User:** What are some of the highlights of the video? **Assistant:** The video captures various exhilarating moments of dirt biking, including bikers jumping into the air, ... t = 2min

Context: 128k
 Tokens: 1.2B
 Examples: 173K

Text: Books3
 Doc Length:
 1M+
 Context: 1M
 Tokens: 1B
 Examples: 0.8K

Video (4000 frames): Valley-Instruct-73k + Video-Instruct 100k



t = 0s **User:** Could you provide a brief summary of the employee's actions? **Assistant:** In the video, an employee prepares a sub. After assembling the bread, ham, pepperoni, salami, and cheese, he toasts the sub in the oven... t = 10min

Context: 1M
 Tokens: 200M
 Examples: 173K

Large World Model



Figure 8 LWM can generate images and videos given text input. Examples of image and video generations. More examples are shown in Appendix E and Appendix D.