

Network Programming: Part II

15-213/14-513/15-513: Introduction to Computer Systems
21st Lecture, November 11, 2021

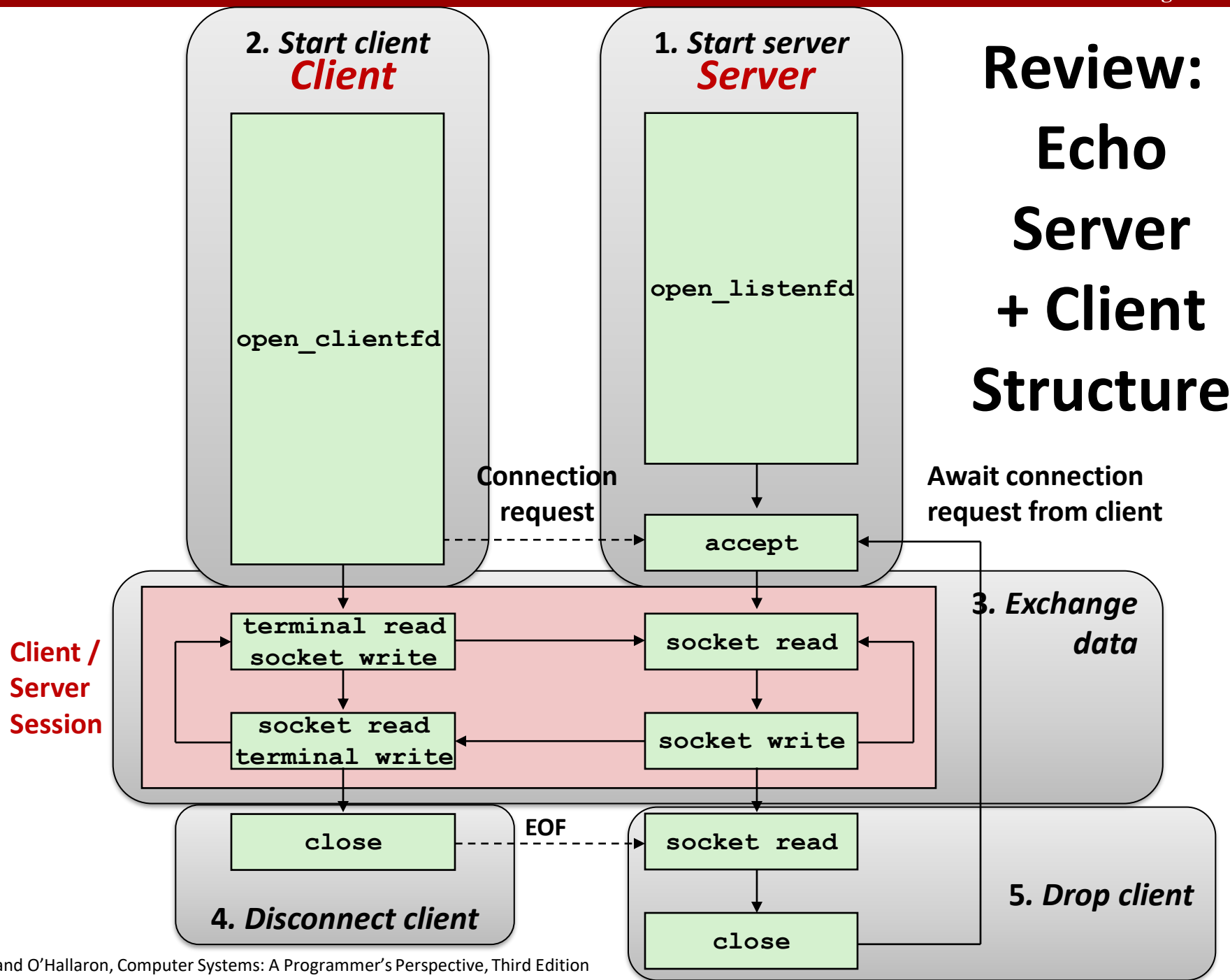

Today

- **The Sockets Interface** CSAPP 11.4
- **Web Servers** CSAPP 11.5.1-11.5.3
- **The Tiny Web Server** CSAPP 11.6
- **Serving Dynamic Content** CSAPP 11.5.4

Sockets Interface

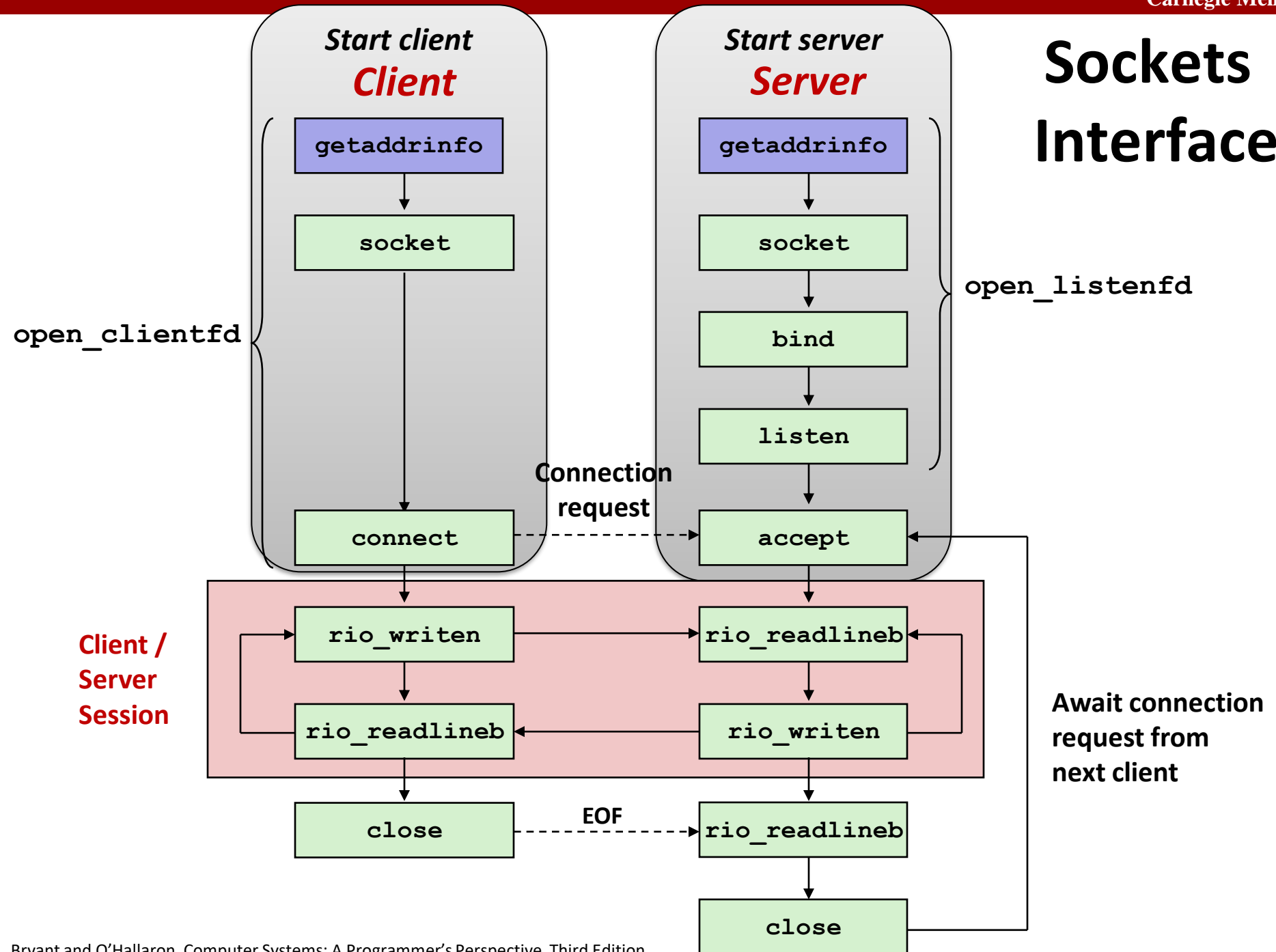

Review: Generic Socket Address

■ Generic socket address:

- For address arguments to **connect**, **bind**, and **accept**

```
struct sockaddr {  
    uint16_t  sa_family;    /* Protocol family */  
    char      sa_data[14]; /* Address data.   */  
};
```

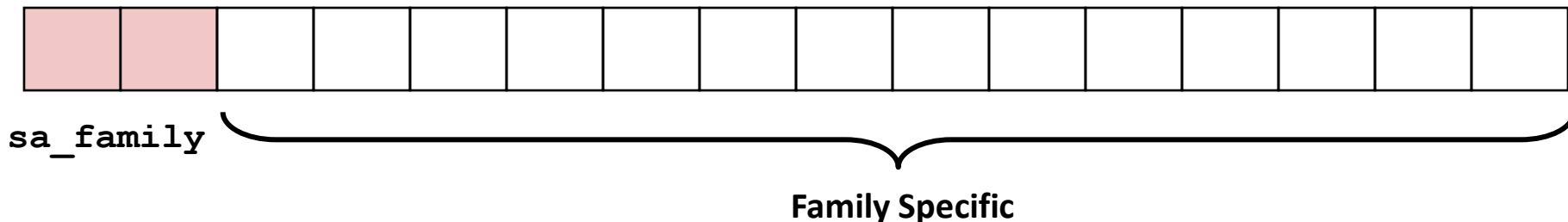

Review: Socket Address Structures

■ Internet (IPv4) specific socket address:

- Must cast (`struct sockaddr_in *`) to (`struct sockaddr *`) for functions that take socket address arguments.

```

struct sockaddr_in {
    uint16_t      sin_family; /* Protocol family (always AF_INET) */
    uint16_t      sin_port;  /* Port num in network byte order */
    struct in_addr sin_addr; /* IP addr in network byte order */
    unsigned char sin_zero[8]; /* Pad to sizeof(struct sockaddr) */
};

```

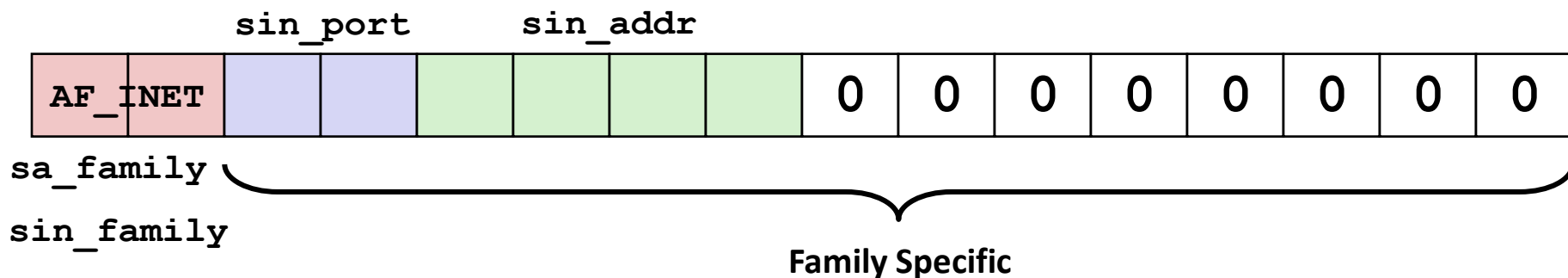

Review: getaddrinfo

- `getaddrinfo` converts string representations of hostnames, host addresses, ports, service names to socket address structures

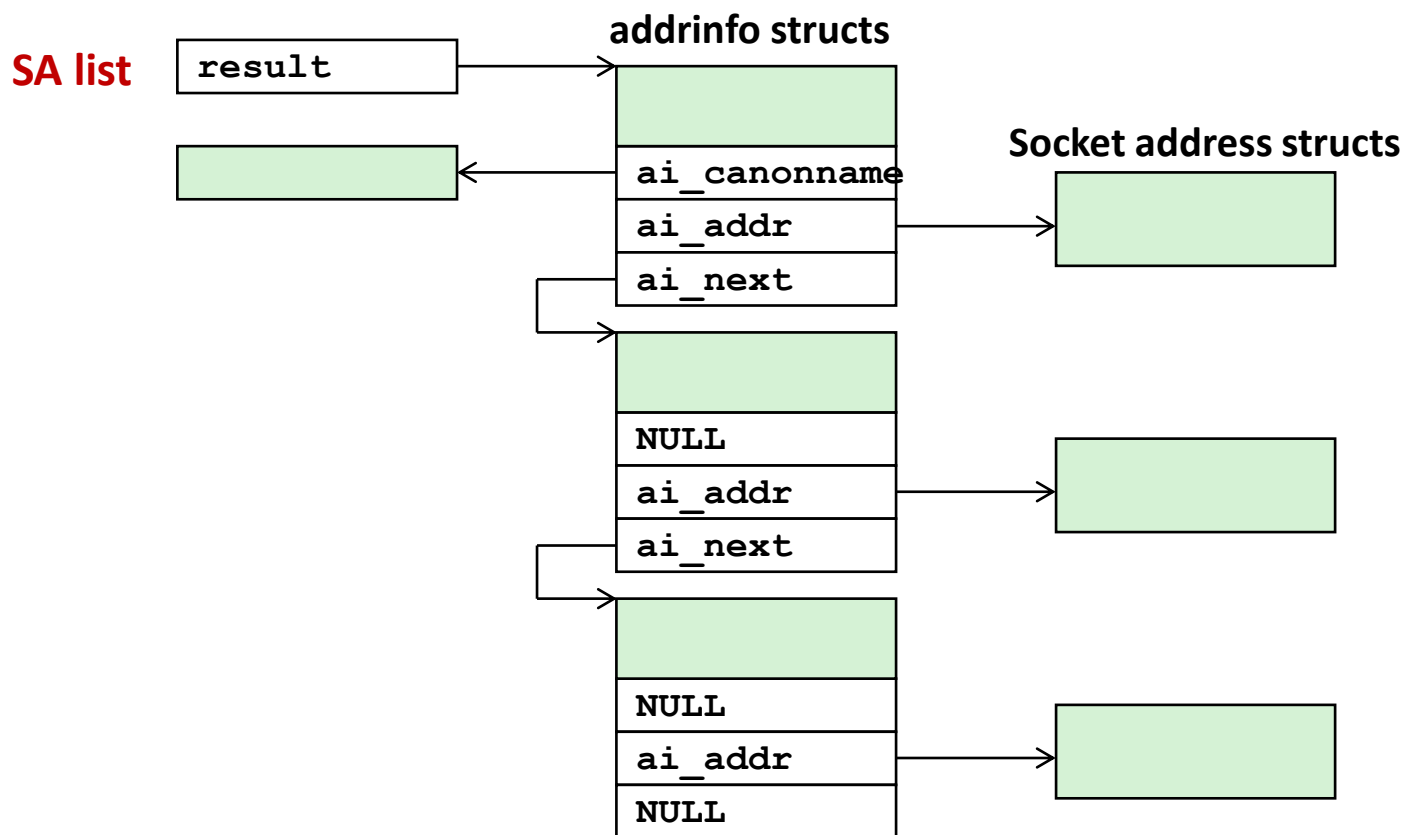

Sockets Interface

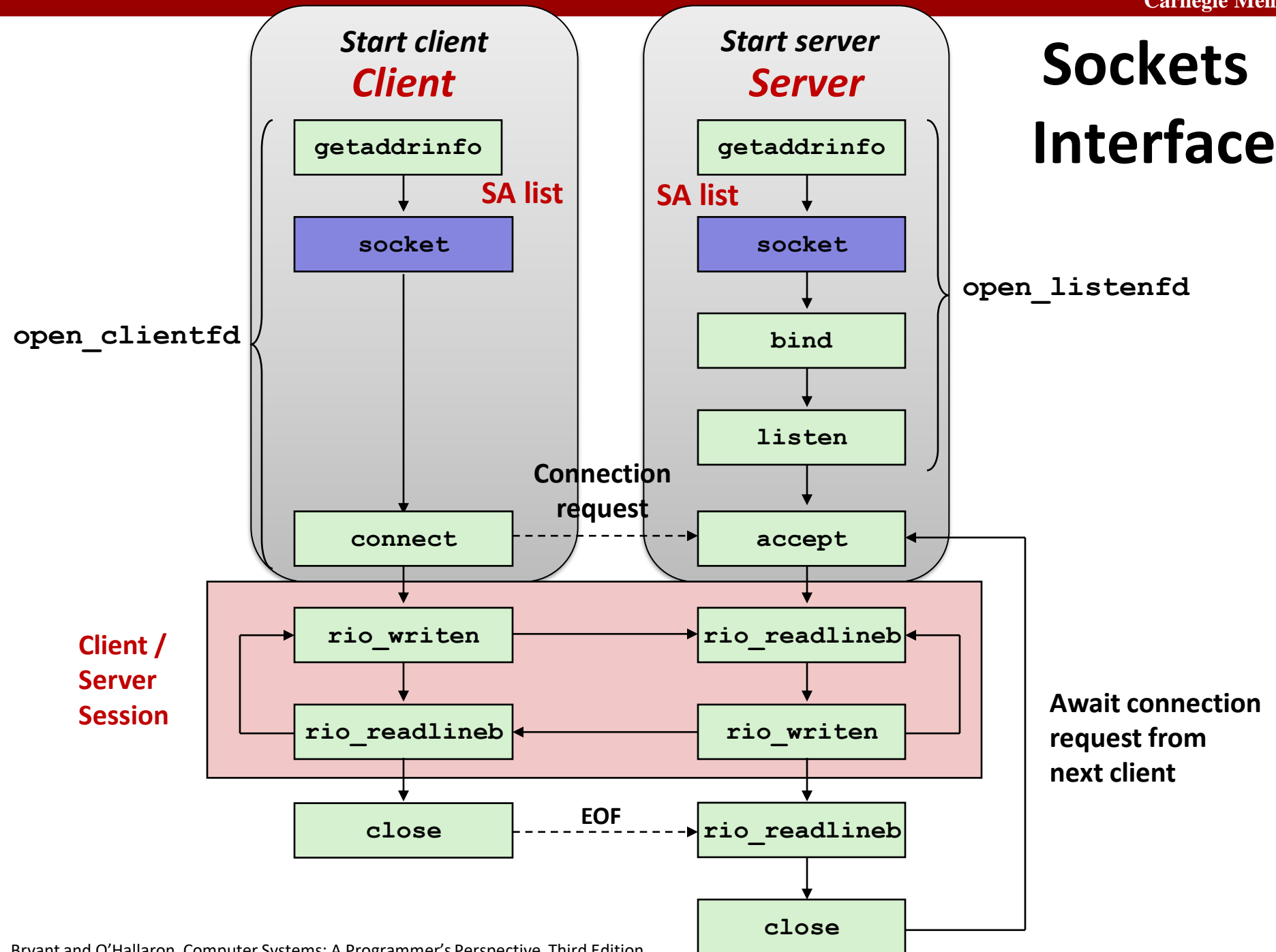

Sockets Interface: `socket`

- Clients and servers use the `socket` function to create a *socket descriptor*:

```
int socket(int domain, int type, int protocol)
```

- Example:

```
int clientfd = socket(AF_INET, SOCK_STREAM, 0);
```

Indicates that we are using
32-bit IPV4 addresses

Indicates that the socket
will be the end point of a
reliable (TCP) connection

Protocol specific! Best practice is to use `getaddrinfo` to generate the parameters automatically, so that code is protocol independent.

Sockets Interface

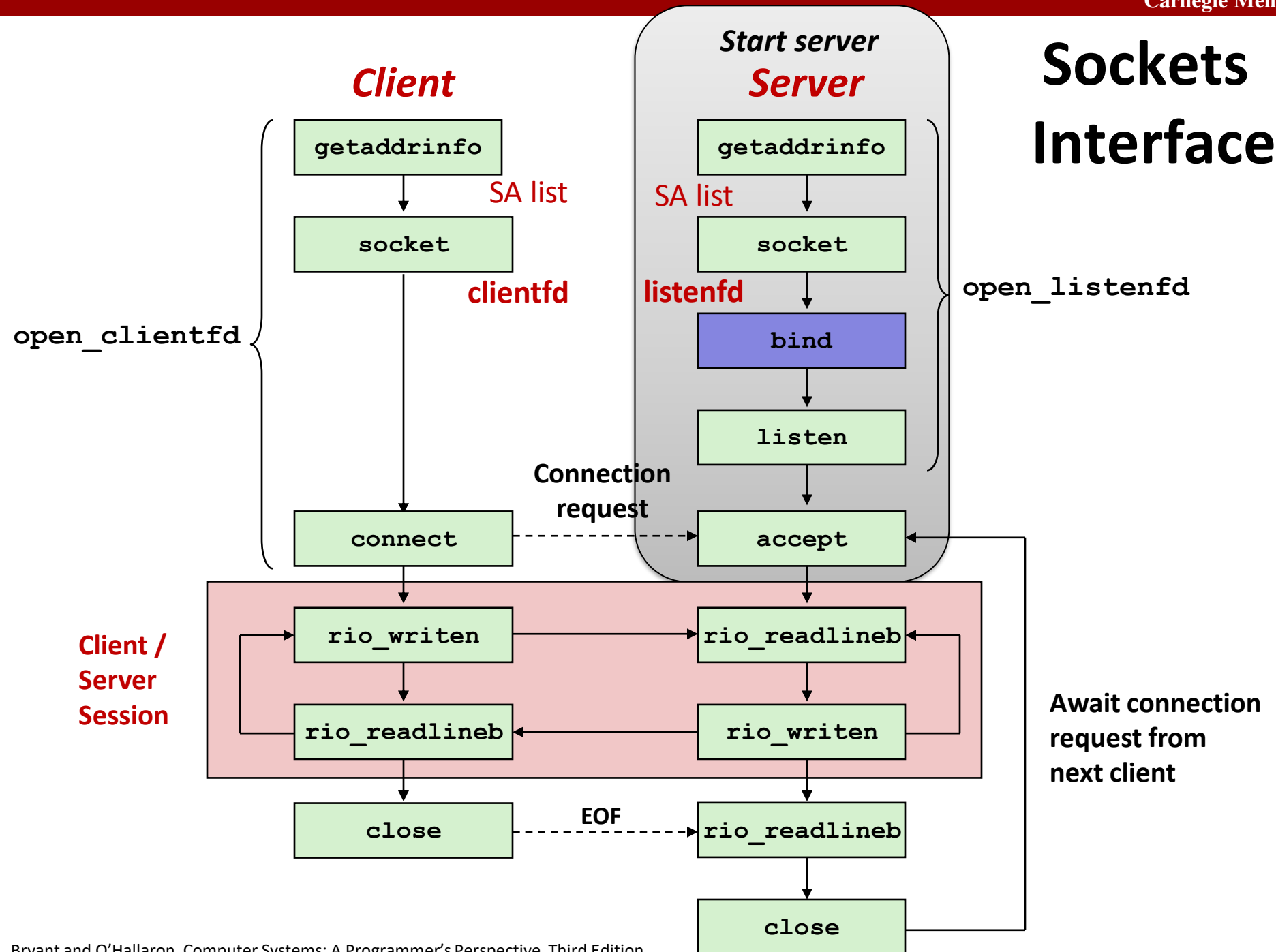

Sockets Interface: `bind`

- A server uses `bind` to ask the kernel to associate the server's socket address with a socket descriptor:

```
int bind(int sockfd, SA *addr, socklen_t addrlen);
```

Our convention: `typedef struct sockaddr SA;`

- Process can read bytes that arrive on the connection whose endpoint is `addr` by reading from descriptor `sockfd`
- Similarly, writes to `sockfd` are transferred along connection whose endpoint is `addr`

Sockets Interface

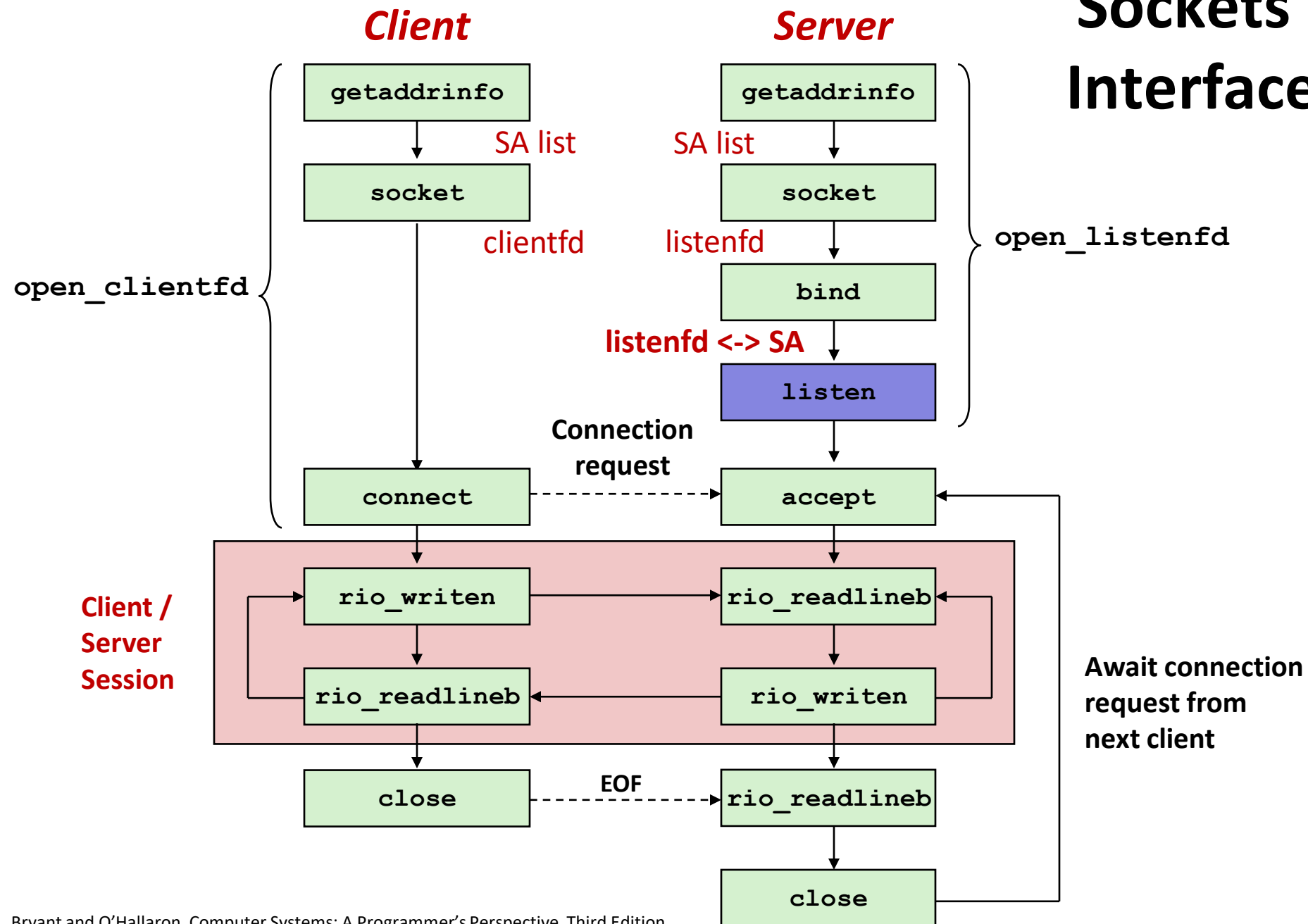

Sockets Interface: `listen`

- Kernel assumes that descriptor from `socket` function is an *active socket* that will be on the client end
- A server calls the `listen` function to tell the kernel that a descriptor will be used by a server rather than a client:

```
int listen(int sockfd, int backlog);
```

- Converts `sockfd` from an active socket to a *listening socket* that can accept connection requests from clients.
- `backlog` is a hint about the number of outstanding connection requests that the kernel should queue up before starting to refuse requests (128-ish by default)

Sockets Interface

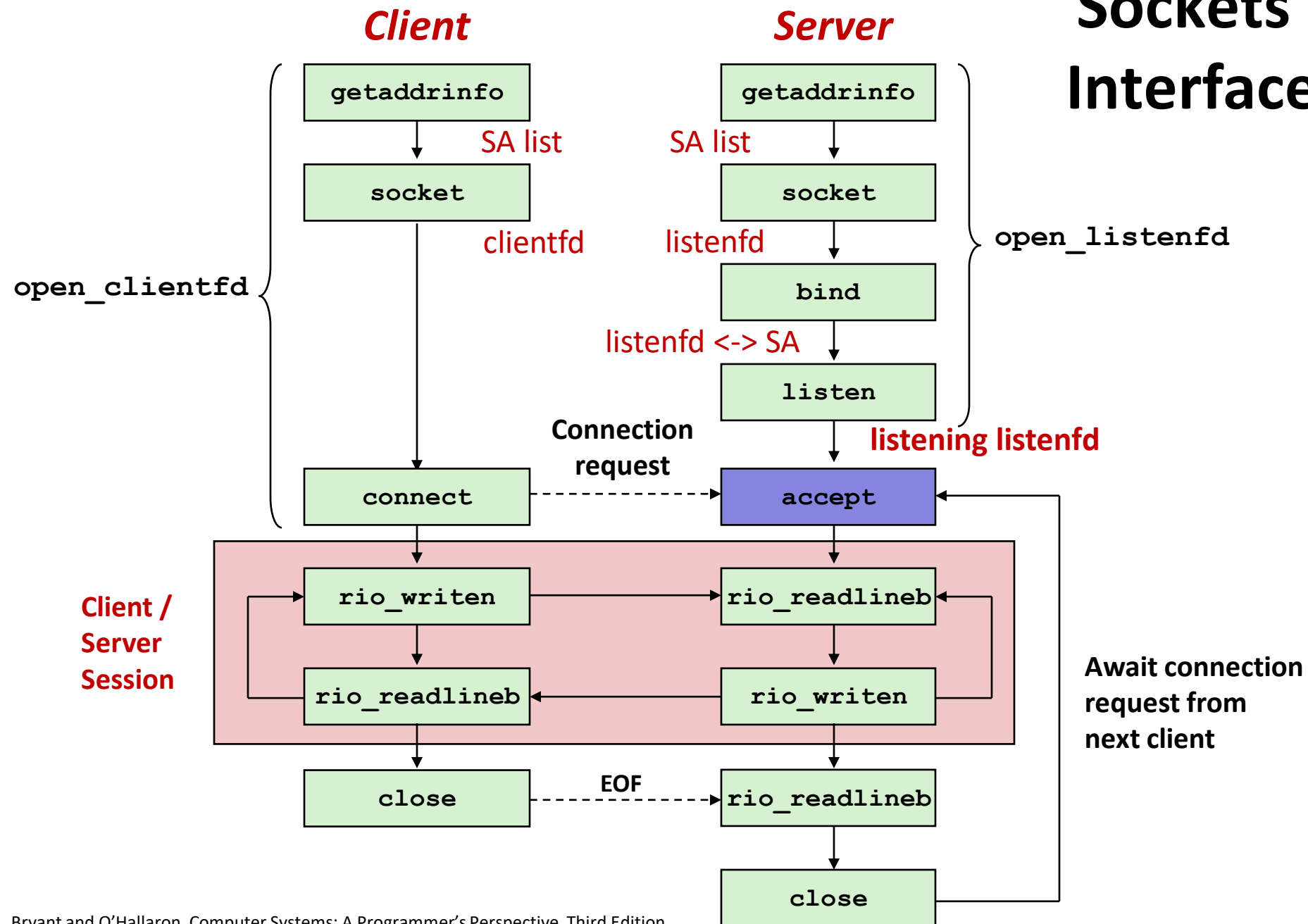

Sockets Interface: `accept`

- Servers wait for connection requests from clients by calling `accept`:

```
int accept(int listenfd, SA *addr, int *addrlen);
```

- Waits for connection request to arrive on the connection bound to `listenfd`, then fills in client's socket address in `addr` and size of the socket address in `addrlen`.
- Returns a ***connected descriptor*** `connfd` that can be used to communicate with the client via Unix I/O routines.

Sockets Interface

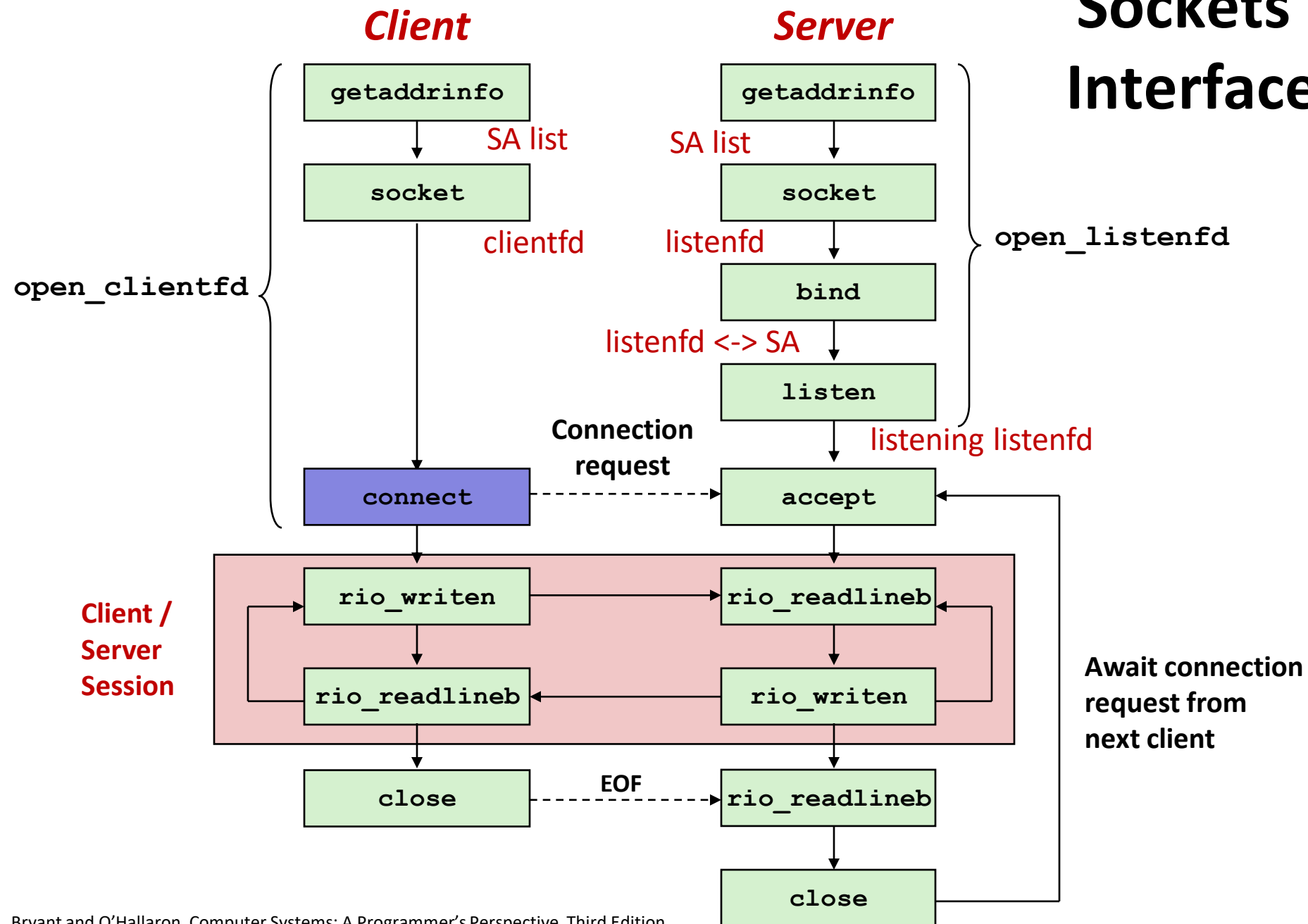

Sockets Interface: connect

- A client establishes a connection with a server by calling `connect`:

```
int connect(int sockfd, SA *addr, socklen_t addrlen);
```

- Attempts to establish a connection with server at socket address `addr`

- If successful, then `sockfd` is now ready for reading and writing.
- Resulting connection is characterized by socket pair
(`x:y`, `addr.sin_addr:addr.sin_port`)
 - `x` is client address
 - `y` is ephemeral port that uniquely identifies client process on client host

Best practice is to use `getaddrinfo` to supply the arguments `addr` and `addrlen`.

connect/accept Illustrated



1. Server blocks in `accept`, waiting for connection request on listening descriptor `listenfd`

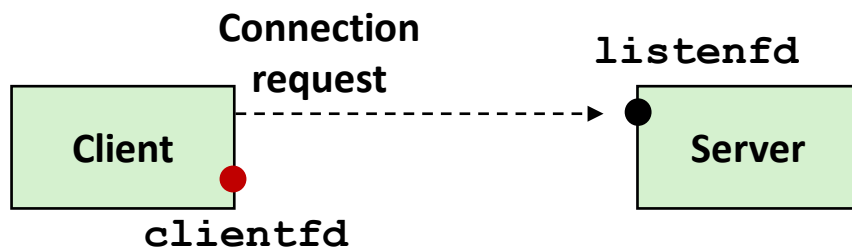

2. Client makes connection request by calling and blocking in `connect`



3. Server returns `connfd` from `accept`. Client returns from `connect`. Connection is now established between `clientfd` and `connfd`

Connected vs. Listening Descriptors

■ Listening descriptor

- End point for client connection requests
- Created once and exists for lifetime of the server

■ Connected descriptor

- End point of the connection between client and server
- A new descriptor is created each time the server accepts a connection request from a client
- Exists only as long as it takes to service client

■ Why the distinction?

- Allows for concurrent servers that can communicate over many client connections simultaneously
 - E.g., Each time we receive a new request, we fork a child to handle the request

Sockets Interface

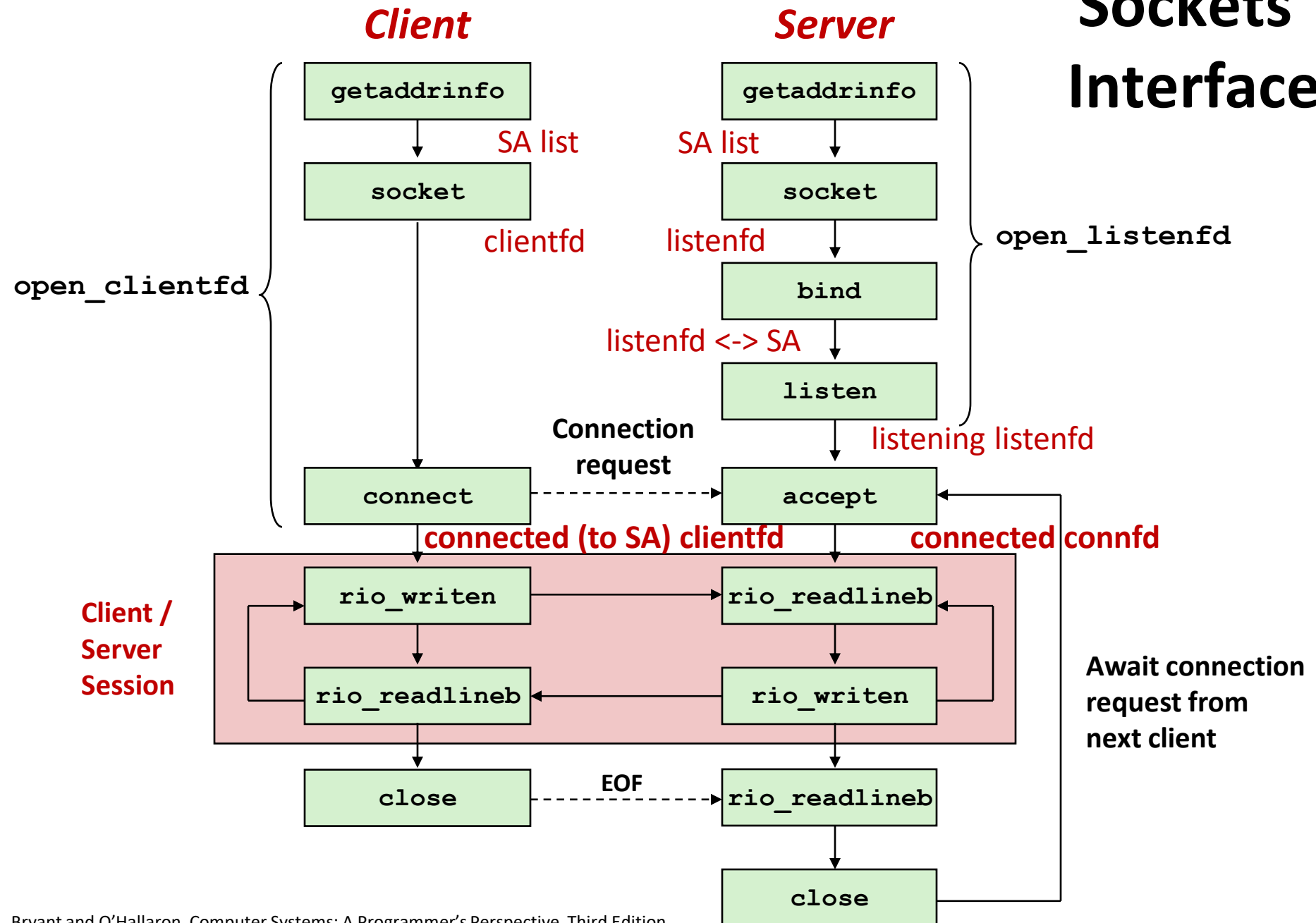

Sockets Interface

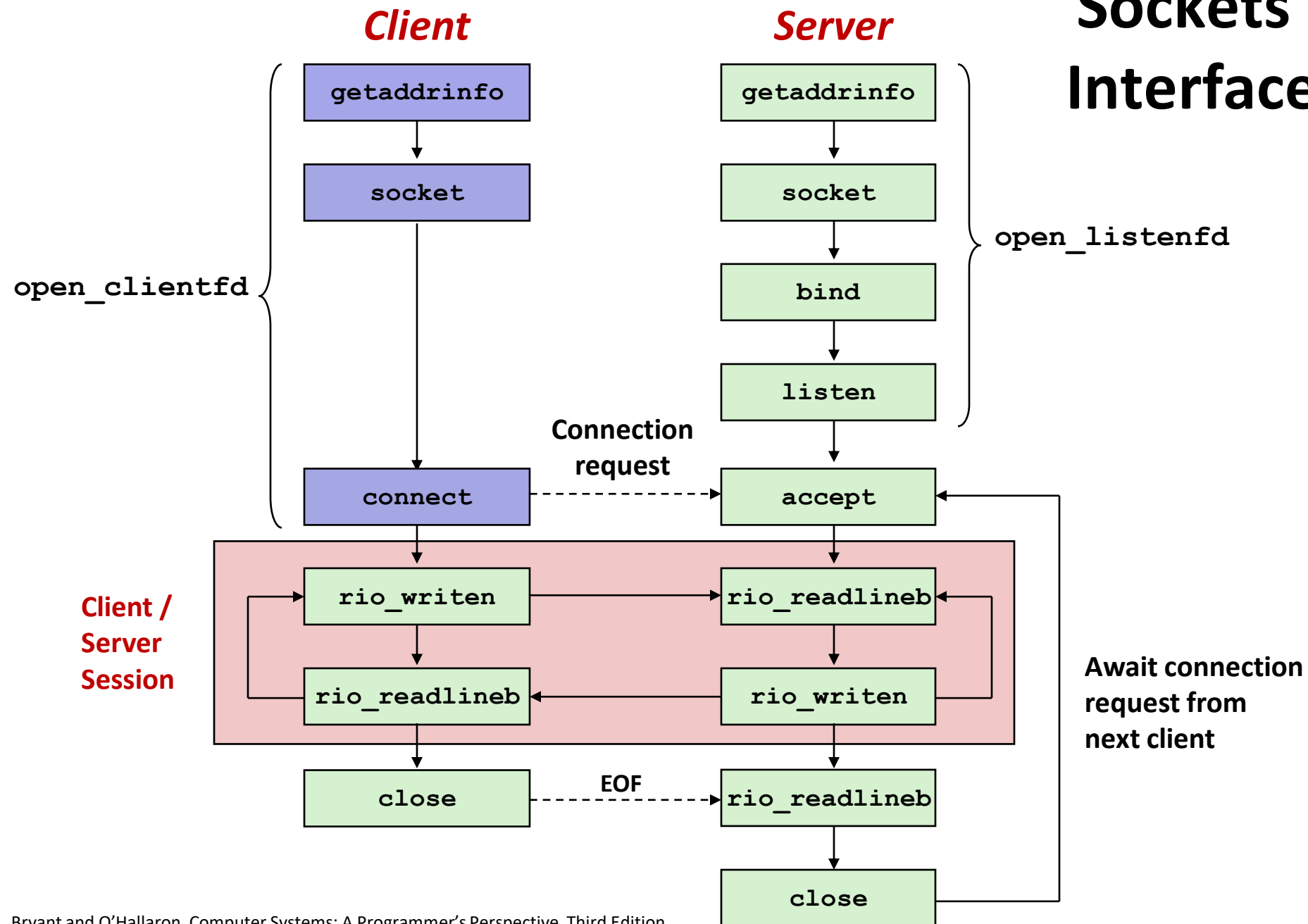

Sockets Helper: `open_clientfd`

- Establish a connection with a server

```
int open_clientfd(char *hostname, char *port) {
    int clientfd;
    struct addrinfo hints, *listp, *p;

    /* Get a list of potential server addresses */
    memset(&hints, 0, sizeof(struct addrinfo));
    hints.ai_socktype = SOCK_STREAM; /* Open a connection */
    hints.ai_flags = AI_NUMERICSERV; /* ...using numeric port arg. */
    hints.ai_flags |= AI_ADDRCONFIG; /* Recommended for connections */
    Getaddrinfo(hostname, port, &hints, &listp);
```

csapp.c

AI_ADDRCONFIG – uses your system's address type.

You have at least one IPV4 iface? IPV4. At least one IPV6? IPV6.

getaddrinfo

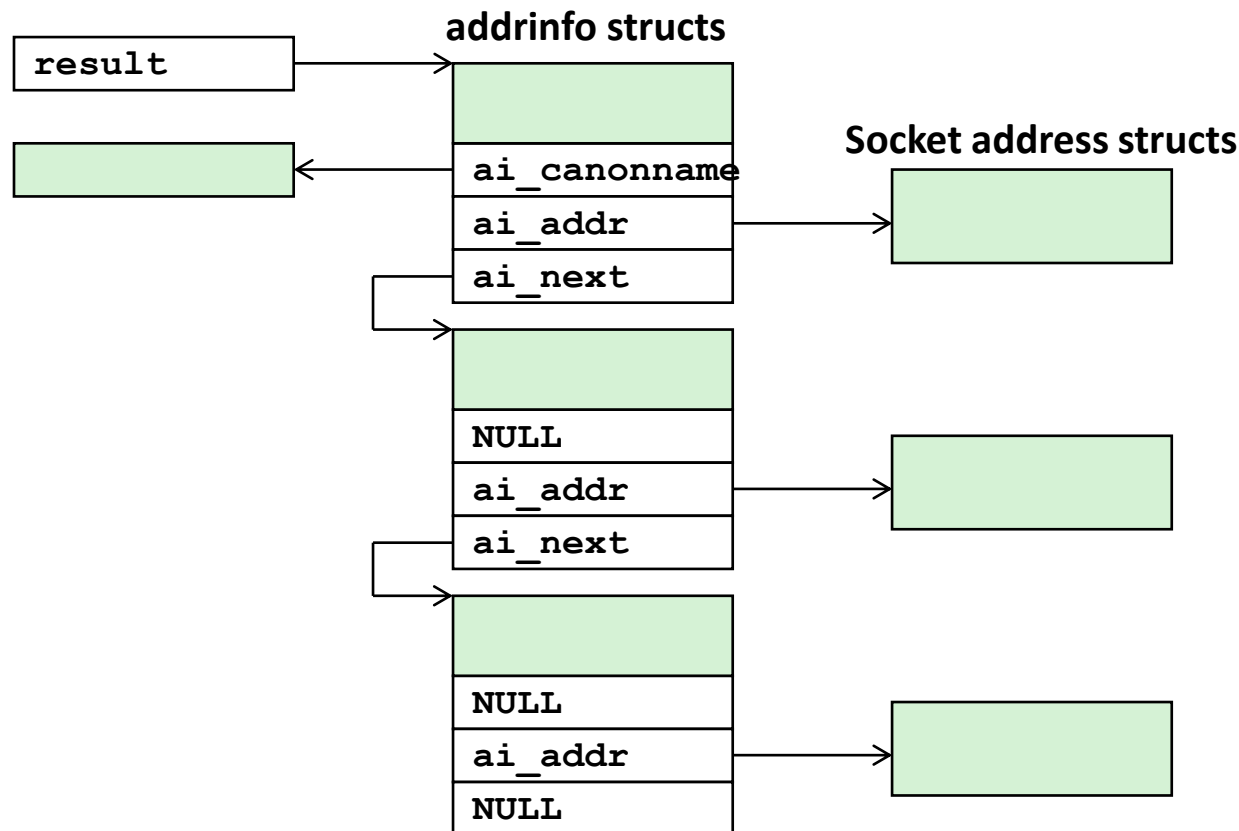

- **Clients:** walk this list, trying each socket address in turn, until the calls to `socket` and `connect` succeed.
- **Servers:** walk the list until calls to `socket` and `bind` succeed.

Sockets Helper: `open_clientfd` (cont)

```
/* Walk the list for one that we can successfully connect to */
for (p = listp; p; p = p->ai_next) {
    /* Create a socket descriptor */
    if ((clientfd = socket(p->ai_family, p->ai_socktype,
                          p->ai_protocol)) < 0)
        continue; /* Socket failed, try the next */

    /* Connect to the server */
    if (connect(clientfd, p->ai_addr, p->ai_addrlen) != -1)
        break; /* Success */
    Close(clientfd); /* Connect failed, try another */
}

/* Clean up */
Freeaddrinfo(listp);
if (!p) /* All connects failed */
    return -1;
else /* The last connect succeeded */
    return clientfd;
}
```

csapp.c

Sockets Interface

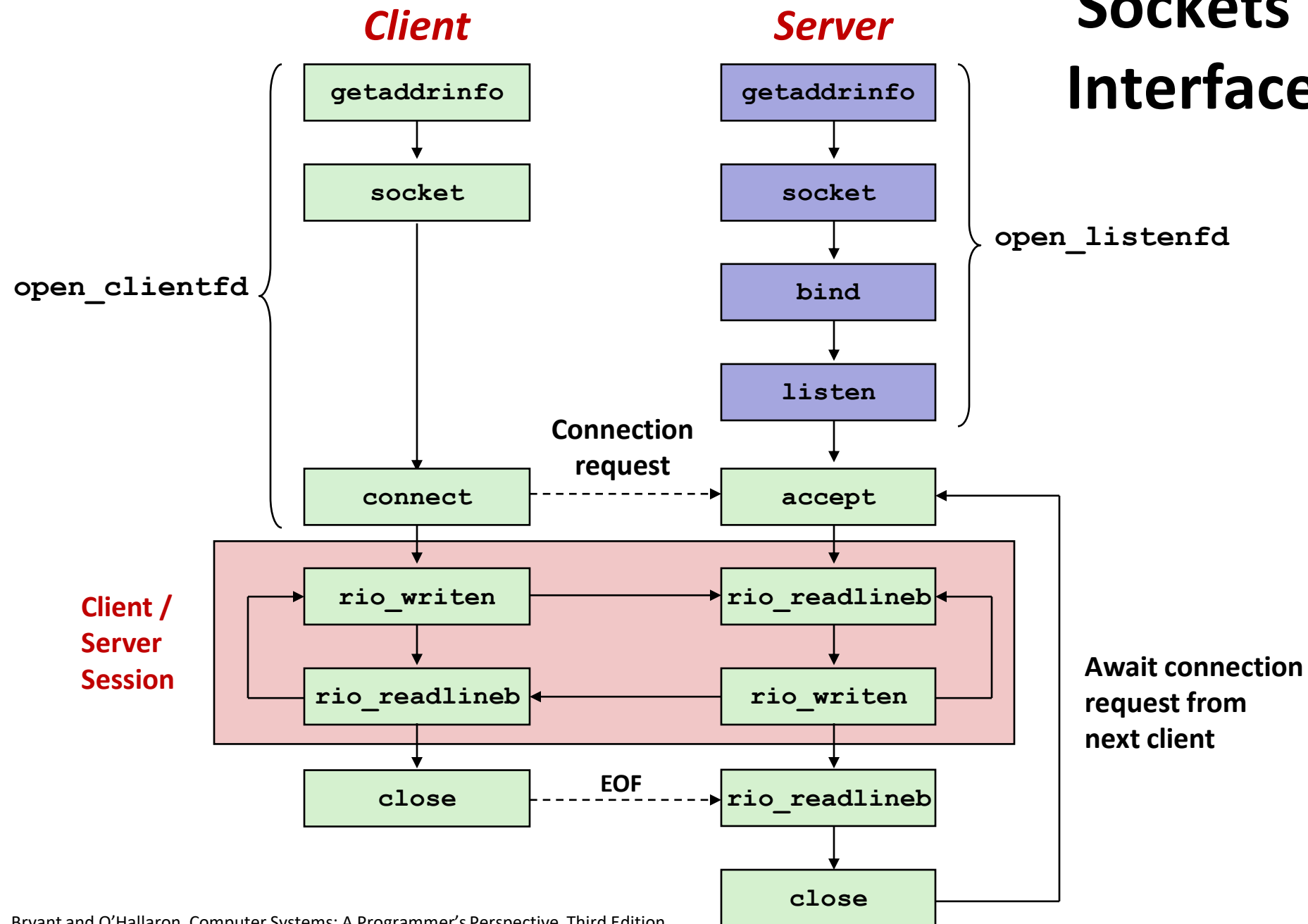

Sockets Helper: `open_listenfd`

- Create a listening descriptor that can be used to accept connection requests from clients.

```
int open_listenfd(char *port)
{
    struct addrinfo hints, *listp, *p;
    int listenfd, optval=1;

    /* Get a list of potential server addresses */
    memset(&hints, 0, sizeof(struct addrinfo));
    hints.ai_socktype = SOCK_STREAM; /* Accept connect. */
    hints.ai_flags = AI_PASSIVE | AI_ADDRCONFIG; /* ...on any IP addr */
    hints.ai_flags |= AI_NUMERICSERV; /* ...using port no. */
    Getaddrinfo(NULL, port, &hints, &listp);
```

csapp.c

Sockets Helper: `open_listenfd` (cont)

```
/* Walk the list for one that we can bind to */
for (p = listp; p; p = p->ai_next) {
    /* Create a socket descriptor */
    if ((listenfd = socket(p->ai_family, p->ai_socktype,
                          p->ai_protocol)) < 0)
        continue; /* Socket failed, try the next */

    /* Eliminates "Address already in use" error from bind */
    Setsockopt(listenfd, SOL_SOCKET, SO_REUSEADDR,
               (const void *)&optval , sizeof(int));

    /* Bind the descriptor to the address */
    if (bind(listenfd, p->ai_addr, p->ai_addrlen) == 0)
        break; /* Success */
    Close(listenfd); /* Bind failed, try the next */
}
```

csapp.c

Sockets Helper: `open_listenfd` (cont)

```
/* Clean up */
Freeaddrinfo(listp);
if (!p) /* No address worked */
    return -1;

/* Make it a listening socket ready to accept conn. requests */
if (listen(listenfd, LISTENQ) < 0) {
    Close(listenfd);
    return -1;
}
return listenfd;
}
```

csapp.c

- **Key point:** `open_clientfd` and `open_listenfd` are both independent of any particular version of IP.

Testing Servers Using `telnet`

- The `telnet` program is invaluable for testing servers that transmit ASCII strings over Internet connections
 - Our simple echo server
 - Web servers
 - Mail servers
- Usage:
 - `linux> telnet <host> <portnumber>`
 - Creates a connection with a server running on `<host>` and listening on port `<portnumber>`

Testing the Echo Server With telnet

```
whaleshark> ./echoserveri 15213
Connected to (MAKOSHARK.ICS.CS.CMU.EDU, 50280)
server received 11 bytes
server received 8 bytes

makoshark> telnet whaleshark.ics.cs.cmu.edu 15213
Trying 128.2.210.175...
Connected to whaleshark.ics.cs.cmu.edu (128.2.210.175).
Escape character is '^]'.
Hi there!
Hi there!
Howdy!
Howdy!
^]
telnet> quit
Connection closed.
makoshark>
```

Today

- The Sockets Interface
- **Web Servers**
- The Tiny Web Server
- Serving Dynamic Content

Web Server Basics

- **Clients and servers communicate using the HyperText Transfer Protocol (HTTP)**
 - Client and server establish TCP connection
 - Client requests content
 - Server responds with requested content
 - Client and server close connection (eventually)
- **Current version is HTTP/1.1**
 - RFC 2616, June, 1999.

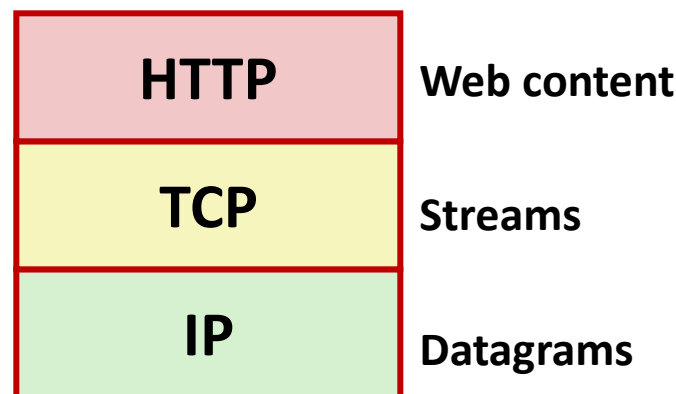
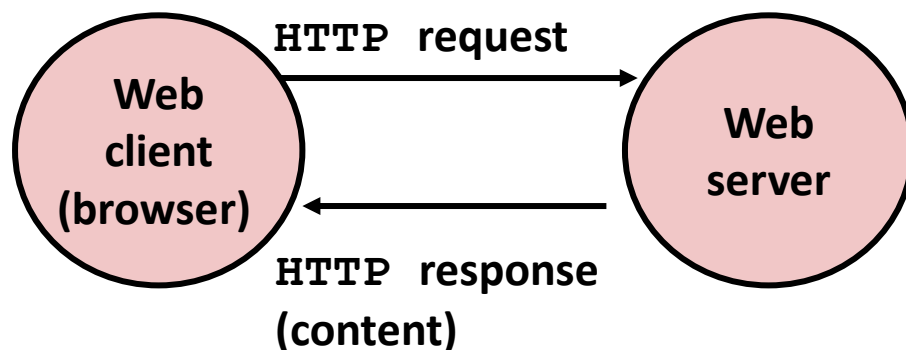

`http://www.w3.org/Protocols/rfc2616/rfc2616.html`

Web Content

■ Web servers return *content* to clients

- *content*: a sequence of bytes with an associated MIME (Multipurpose Internet Mail Extensions) type

■ Example MIME types

- `text/html` HTML document
- `text/plain` Unformatted text
- `image/gif` Binary image encoded in GIF format
- `image/png` Binary image encoded in PNG format
- `image/jpeg` Binary image encoded in JPEG format

You can find the complete list of MIME types at:

<http://www.iana.org/assignments/media-types/media-types.xhtml>

Static and Dynamic Content

- The content returned in HTTP responses can be either *static* or *dynamic*
 - *Static content*: content stored in files and retrieved in response to an HTTP request
 - Examples: HTML files, images, audio clips, Javascript programs
 - Request identifies which content file
 - *Dynamic content*: content produced on-the-fly in response to an HTTP request
 - Example: content produced by a program executed by the server on behalf of the client
 - Request identifies file containing executable code
- ***Web content associated with a file that is managed by the server***

URLs and how clients and servers use them

- Unique name for a file: URL (Universal Resource Locator)
- Example URL: `http://www.cmu.edu:80/index.html`
- Clients use *prefix* (`http://www.cmu.edu:80`) to infer:
 - What kind (protocol) of server to contact (HTTP)
 - Where the server is (`www.cmu.edu`)
 - What port it is listening on (80)
- Servers use *suffix* (`/index.html`) to:
 - Determine if request is for static or dynamic content.
 - No hard and fast rules for this
 - One convention: executables reside in `cgi-bin` directory
 - Find file on file system
 - Initial “/” in suffix denotes home directory for requested content.
 - Minimal suffix is “/”, which server expands to configured default filename (usually, `index.html`)

HTTP Requests

- HTTP request is a *request line*, followed by zero or more *request headers*
- Request line: `<method> <uri> <version>`
 - `<method>` is one of GET, POST, OPTIONS, HEAD, PUT, DELETE, or TRACE
 - `<uri>` is typically URL for proxies, URL suffix for servers
 - A URL is a type of URI (Uniform Resource Identifier)
 - See <http://www.ietf.org/rfc/rfc2396.txt>
 - `<version>` is HTTP version of request (HTTP/1.0 or HTTP/1.1)
- Request headers: `<header name>: <header data>`
 - Provide additional information to the server

HTTP Responses

- HTTP response is a *response line* followed by zero or more *response headers*, possibly followed by *content*, with blank line (“\r\n”) separating headers from content.
- Response line:
 - `<version> <status code> <status msg>`
 - `<version>` is HTTP version of the response
 - `<status code>` is numeric status
 - `<status msg>` is corresponding English text
 - `200 OK` Request was handled without error
 - `301 Moved` Provide alternate URL
 - `404 Not found` Server couldn't find the file
- Response headers: `<header name>: <header data>`
 - Provide additional information about response
 - **Content-Type**: MIME type of content in response body
 - **Content-Length**: Length of content in response body

Example HTTP Transaction

whaleshark> telnet www.cmu.edu 80	Client: open connection to server
Trying 128.2.42.52...	Telnet prints 3 lines to terminal
Connected to WWW-CMU-PROD-VIP.ANDREW.cmu.edu.	
Escape character is '^]'. GET / HTTP/1.1	Client: request line
Host: www.cmu.edu	Client: required HTTP/1.1 header
	Client: blank line terminates headers
HTTP/1.1 301 Moved Permanently	Server: response line
Date: Wed, 05 Nov 2014 17:05:11 GMT	Server: followed by 5 response headers
Server: Apache/1.3.42 (Unix)	Server: this is an Apache server
Location: http://www.cmu.edu/index.shtml	Server: page has moved here
Transfer-Encoding: chunked	Server: response body will be chunked
Content-Type: text/html; charset=...	Server: expect HTML in response body
	Server: empty line terminates headers
15c	Server: first line in response body
<HTML><HEAD>	Server: start of HTML content
...	
</BODY></HTML>	Server: end of HTML content
0	Server: last line in response body
Connection closed by foreign host.	Server: closes connection

- HTTP standard requires that each text line end with “\r\n”
- Blank line (“\r\n”) terminates request and response headers

Example HTTP Transaction, Take 2

whaleshark> telnet www.cmu.edu 80	Client: open connection to server
Trying 128.2.42.52...	Telnet prints 3 lines to terminal
Connected to WWW-CMU-PROD-VIP.ANDREW.cmu.edu.	
Escape character is '^]'. GET /index.shtml HTTP/1.1	Client: request line
Host: www.cmu.edu	Client: required HTTP/1.1 header
	Client: blank line terminates headers
HTTP/1.1 200 OK	Server: response line
Date: Wed, 05 Nov 2014 17:37:26 GMT	Server: followed by 4 response headers
Server: Apache/1.3.42 (Unix)	
Transfer-Encoding: chunked	
Content-Type: text/html; charset=...	
1000	Server: empty line terminates headers
<html ..>	Server: begin response body
...	Server: first line of HTML content
</html>	
0	Server: end response body
Connection closed by foreign host.	Server: close connection

Example HTTP(S) Transaction, Take 3

```
whaleshark> openssl s_client www.cs.cmu.edu:443
CONNECTED(00000005)
...
Certificate chain
...
-
Server certificate
-----BEGIN CERTIFICATE-----
MIIGDjCCBPagAwIBAgIRAMiF7LBPDoySilnNoU+mp+gwDQYJKoZIhvcNAQELBQAw
djELMAkGA1UEBhMCVVMxCzAJBgNVBAGTAk1JMRIwEAYDVQQHEw1Bbm4gQXJib3Ix
EjAQBgNVBAoTCUluZGVybmV0MjERMA8GA1UECzMISW5Db21tb24xHzAdBgNVBAMT
wkWkvDVBBCwKXrShVxQNsJ6J
...
-----END CERTIFICATE-----
subject=/C=US/postalCode=15213/ST=PA/L=Pittsburgh/street=5000 Forbes
Ave/O=Carnegie Mellon University/OU=School of Computer
Science/CN=www.cs.cmu.edu issuer=/C=US/ST=MI/L=Ann
Arbor/O=Internet2/OU=InCommon/CN=InCommon RSA Server CA
SSL handshake has read 6274 bytes and written 483 bytes
...
>GET / HTTP/1.0

HTTP/1.1 200 OK
Date: Tue, 12 Nov 2019 04:22:15 GMT
Server: Apache/2.4.10 (Ubuntu)
Set-Cookie: SHIBLOCATION=scsweb; path=/; domain=.cs.cmu.edu
... HTML Content Continues Below ...
```

Quiz

<https://canvas.cmu.edu/courses/24383/quizzes/67236>

Today

- The Sockets Interface
- Web Servers
- **The Tiny Web Server**
- Serving Dynamic Content

Tiny Web Server

■ Tiny Web server described in text

- Tiny is a sequential Web server
- Serves static and dynamic content to real browsers
 - text files, HTML files, GIF, PNG, and JPEG images
- 239 lines of commented C code
- Not as complete or robust as a real Web server
 - You can break it with poorly-formed HTTP requests (e.g., terminate lines with “\n” instead of “\r\n”)

Tiny Operation

- **Accept connection from client**
- **Read request from client (via connected socket)**
- **Split into <method> <uri> <version>**
 - If method not GET, then return error
- **If URI contains “cgi-bin” then serve dynamic content**
 - (Would do wrong thing if had file “abcgi-bingo.html”)
 - Fork process to execute program
- **Otherwise serve static content**
 - Copy file to output

Tiny Serving Static Content

```
void serve_static(int fd, char *filename, int filesize)
{
    int srcfd;
    char *srcp, filetype[MAXLINE], buf[MAXBUF];

    /* Send response headers to client */
    get_filetype(filename, filetype);
    sprintf(buf, "HTTP/1.0 200 OK\r\n");
    sprintf(buf, "%sServer: Tiny Web Server\r\n", buf);
    sprintf(buf, "%sConnection: close\r\n", buf);
    sprintf(buf, "%sContent-length: %d\r\n", buf, filesize);
    sprintf(buf, "%sContent-type: %s\r\n\r\n", buf, filetype);
    Rio_writen(fd, buf, strlen(buf));

    /* Send response body to client */
    srcfd = Open(filename, O_RDONLY, 0);
    srcp = Mmap(0, filesize, PROT_READ, MAP_PRIVATE, srcfd, 0);
    Close(srcfd);
    Rio_writen(fd, srcp, filesize);
    Munmap(srcp, filesize);
}
```

tiny.c

Today

- The Sockets Interface
- Web Servers
- The Tiny Web Server
- **Serving Dynamic Content**

Serving Dynamic Content

- Client sends request to server
- If request URI contains the string `"/cgi-bin"`, the Tiny server assumes that the request is for dynamic content

`GET /cgi-bin/env.pl HTTP/1.1`

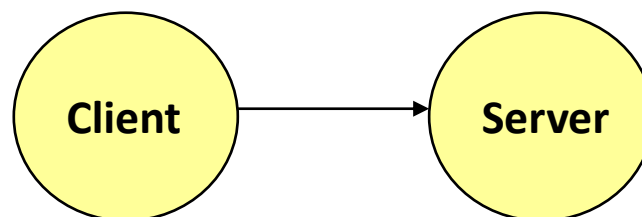

Serving Dynamic Content (cont)

- The server creates a child process and runs the program identified by the URI in that process

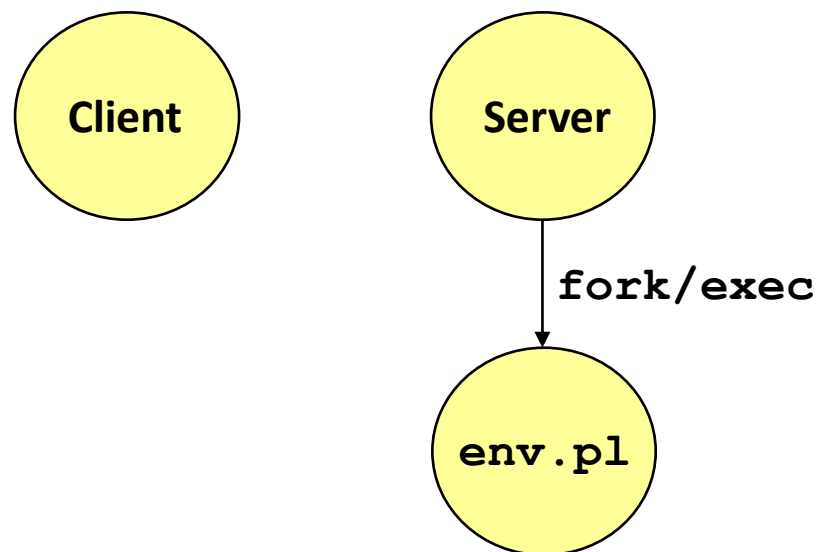

Serving Dynamic Content (cont)

- The child runs and generates the dynamic content
- The server captures the content of the child and forwards it without modification to the client

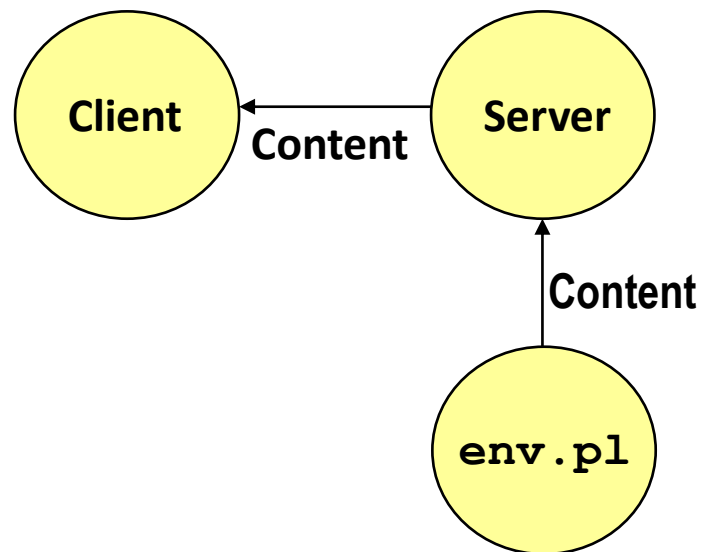

Issues in Serving Dynamic Content

- How does the client pass program arguments to the server?
- How does the server pass these arguments to the child?
- How does the server pass other info relevant to the request to the child?
- How does the server capture the content produced by the child?
- These issues are addressed by the **Common Gateway Interface (CGI)** specification.

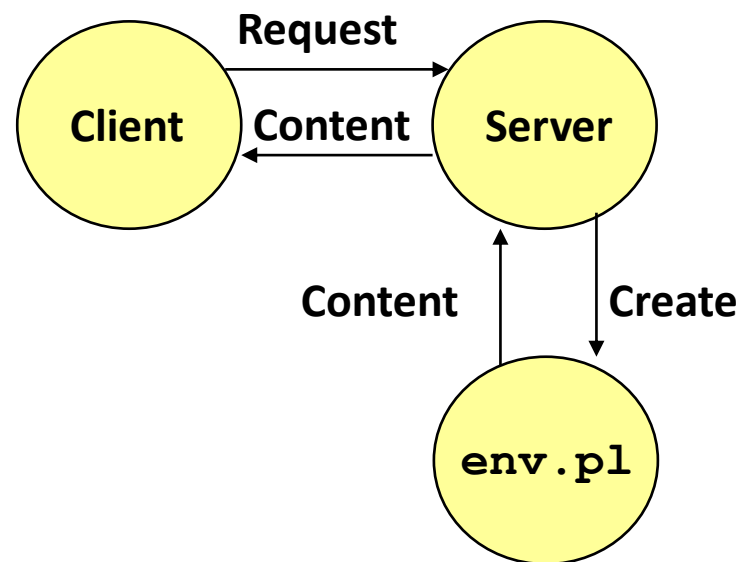

CGI

- Because the children are written according to the CGI spec, they are often called *CGI programs*.
- However, CGI really defines a simple standard for transferring information between the client (browser), the server, and the child process.
- CGI is the original standard for generating dynamic content. Has been largely replaced by other, faster techniques:
 - E.g., fastCGI, Apache modules, Java servlets, Rails controllers
 - Avoid having to create process on the fly (expensive and slow).

The add.com Experience

host

port

CGI program

arguments

whaleshark.ics.cs.cmu.edu

whaleshark.ics.cs.cmu.edu:15213/cgi-bin/adder?15213&18213

Welcome to add.com: THE Internet addition portal.

The answer is: $15213 + 18213 = 33426$

Thanks for visiting!

Output page

Serving Dynamic Content With GET

- Question: How does the client pass arguments to the server?
- Answer: The arguments are appended to the URI
- Can be encoded directly in a URL typed to a browser or a URL in an HTML link
 - `http://add.com/cgi-bin/adder?15213&18213`
 - `adder` is the CGI program on the server that will do the addition.
 - argument list starts with “?”
 - arguments separated by “&”
 - spaces represented by “+” or “%20”

Serving Dynamic Content With GET

- URL suffix:
 - `cgi-bin/adder?15213&18213`
- Result displayed on browser:

```
Welcome to add.com: THE Internet  
addition portal.
```

```
The answer is: 15213 + 18213 = 33426
```

```
Thanks for visiting!
```

Serving Dynamic Content With GET

- **Question**: How does the server pass these arguments to the child?
- **Answer**: In environment variable `QUERY_STRING`
 - A single string containing everything after the “?”
 - For add: `QUERY_STRING = “15213&18213”`

```
/* Extract the two arguments */  
if ((buf = getenv("QUERY_STRING")) != NULL) {  
    p = strchr(buf, '&');  
    *p = '\0';  
    strcpy(arg1, buf);  
    strcpy(arg2, p+1);  
    n1 = atoi(arg1);  
    n2 = atoi(arg2);  
}
```

adder.c

Serving Dynamic Content with GET

- Question: How does the server capture the content produced by the child?
- Answer: The child generates its output on `stdout`. Server uses `dup2` to redirect `stdout` to its connected socket.

```
void serve_dynamic(int fd, char *filename, char *cgiargs)
{
    char buf[MAXLINE], *emptylist[] = { NULL };

    /* Return first part of HTTP response */
    sprintf(buf, "HTTP/1.0 200 OK\r\n");
    Rio_writen(fd, buf, strlen(buf));
    sprintf(buf, "Server: Tiny Web Server\r\n");
    Rio_writen(fd, buf, strlen(buf));

    if (Fork() == 0) { /* Child */
        /* Real server would set all CGI vars here */
        setenv("QUERY_STRING", cgiargs, 1);
        Dup2(fd, STDOUT_FILENO); /* Redirect stdout to client */
        Execve(filename, emptylist, environ); /* Run CGI program */
    }
    Wait(NULL); /* Parent waits for and reaps child */
}
```

Serving Dynamic Content with GET

- Notice that only the CGI child process knows the content type and length, so it must generate those headers.

```
/* Make the response body */
sprintf(content, "Welcome to add.com: ");
sprintf(content, "%sTHE Internet addition portal.\r\n<p>", content);
sprintf(content, "%sThe answer is: %d + %d = %d\r\n<p>",
        content, n1, n2, n1 + n2);
sprintf(content, "%sThanks for visiting!\r\n", content);

/* Generate the HTTP response */
printf("Content-length: %d\r\n", (int)strlen(content));
printf("Content-type: text/html\r\n\r\n");
printf("%s", content);
fflush(stdout);

exit(0);
```

adder.c

Serving Dynamic Content With GET

```
bash:makoshark> telnet whaleshark.ics.cs.cmu.edu 15213
Trying 128.2.210.175...
Connected to whaleshark.ics.cs.cmu.edu (128.2.210.175) .
Escape character is '^]'.
GET /cgi-bin/adder?15213&18213 HTTP/1.0
```

HTTP request sent by client

```
HTTP/1.0 200 OK
Server: Tiny Web Server
Connection: close
```

*HTTP response generated
by the server*

```
Content-length: 117
Content-type: text/html
```

*HTTP response generated
by the CGI program*

```
Welcome to add.com: THE Internet addition portal.
<p>The answer is: 15213 + 18213 = 33426
<p>Thanks for visiting!
```

```
Connection closed by foreign host.
```

```
bash:makoshark>
```

For More Information

- **W. Richard Stevens et. al. “Unix Network Programming: The Sockets Networking API”, Volume 1, Third Edition, Prentice Hall, 2003**
 - THE network programming bible.
- **Michael Kerrisk, “The Linux Programming Interface”, No Starch Press, 2010**
 - THE Linux programming bible.
- **Complete versions of all code in this lecture is available from the 213 schedule page.**
 - `http://www.cs.cmu.edu/~213/schedule.html`
 - `csapp.{c,h}`, `hostinfo.c`, `echoclient.c`, `echoserveri.c`, `tiny.c`, `adder.c`
 - You can use any of this code in your assignments.

Additional slides

Web History

■ 1989:

- Tim Berners-Lee (CERN) writes internal proposal to develop a distributed hypertext system
 - Connects “a web of notes with links”
 - Intended to help CERN physicists in large projects share and manage information

■ 1990:

- Tim BL writes a graphical browser for Next machines

Web History (cont)

■ 1992

- NCSA server released
- 26 WWW servers worldwide

■ 1993

- Marc Andreessen releases first version of NCSA Mosaic browser
- Mosaic version released for (Windows, Mac, Unix)
- Web (port 80) traffic at 1% of NSFNET backbone traffic
- Over 200 WWW servers worldwide

■ 1994

- Andreessen and colleagues leave NCSA to form “Mosaic Communications Corp” (predecessor to Netscape)

HTTP Versions

- **Major differences between HTTP/1.1 and HTTP/1.0**
 - HTTP/1.0 uses a new connection for each transaction
 - HTTP/1.1 also supports *persistent connections*
 - multiple transactions over the same connection
 - `Connection: Keep-Alive`
 - HTTP/1.1 requires `HOST` header
 - `Host: www.cmu.edu`
 - Makes it possible to host multiple websites at single Internet host
 - HTTP/1.1 supports *chunked encoding*
 - `Transfer-Encoding: chunked`
 - HTTP/1.1 adds additional support for caching

GET Request to Apache Server From Firefox Browser

URI is just the suffix, not the entire URL

```
GET /~bryant/test.html HTTP/1.1
Host: www.cs.cmu.edu
User-Agent: Mozilla/5.0 (Windows; U; Windows NT 6.0; en-US;
rv:1.9.2.11) Gecko/20101012 Firefox/3.6.11
Accept:
text/html,application/xhtml+xml,application/xml;q=0.9,*/*;q=0.8
Accept-Language: en-us,en;q=0.5
Accept-Encoding: gzip,deflate
Accept-Charset: ISO-8859-1,utf-8;q=0.7,*;q=0.7
Keep-Alive: 115
Connection: keep-alive
CRLF (\r\n)
```

GET Response From Apache Server

```
HTTP/1.1 200 OK
Date: Fri, 29 Oct 2010 19:48:32 GMT
Server: Apache/2.2.14 (Unix) mod_ssl/2.2.14 OpenSSL/0.9.7m
mod_pubcookie/3.3.2b PHP/5.3.1
Accept-Ranges: bytes
Content-Length: 479
Keep-Alive: timeout=15, max=100
Connection: Keep-Alive
Content-Type: text/html
<html>
<head><title>Some Tests</title></head>

<body>
<h1>Some Tests</h1>
. . .
</body>
</html>
```

Data Transfer Mechanisms

■ Standard

- Specify total length with content-length
- Requires that program buffer entire message

■ Chunked

- Break into blocks
- Prefix each block with number of bytes (Hex coded)

Chunked Encoding Example

```
HTTP/1.1 200 OK\nDate: Sun, 31 Oct 2010 20:47:48 GMT\nServer: Apache/1.3.41 (Unix)\nKeep-Alive: timeout=15, max=100\nConnection: Keep-Alive\nTransfer-Encoding: chunked\nContent-Type: text/html\n\r\n
```

d75\r\n **First Chunk: 0xd75 = 3445 bytes**

```
<html>\n<head>\n.<link href="http://www.cs.cmu.edu/style/calendar.css" rel="stylesheet"\ntype="text/css">\n</head>\n<body id="calendar_body">\n\n<div id='calendar'><table width='100%' border='0' cellpadding='0'\ncellspacing='1' id='cal'>\n\n    . . .\n</body>\n</html>\n\r\n
```

0\r\n **Second Chunk: 0 bytes (indicates last chunk)**

```
\r\n
```

Proxies

- A **proxy** is an intermediary between a client and an **origin server**
 - To the client, the proxy acts like a server
 - To the server, the proxy acts like a client

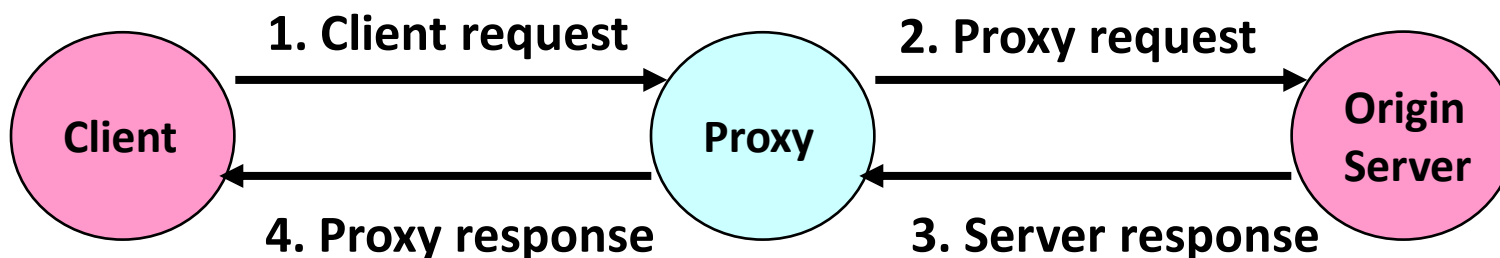

Why Proxies?

- Can perform useful functions as requests and responses pass by
 - Examples: Caching, logging, anonymization, filtering, transcoding

