

Anatomy of the Hippocampus

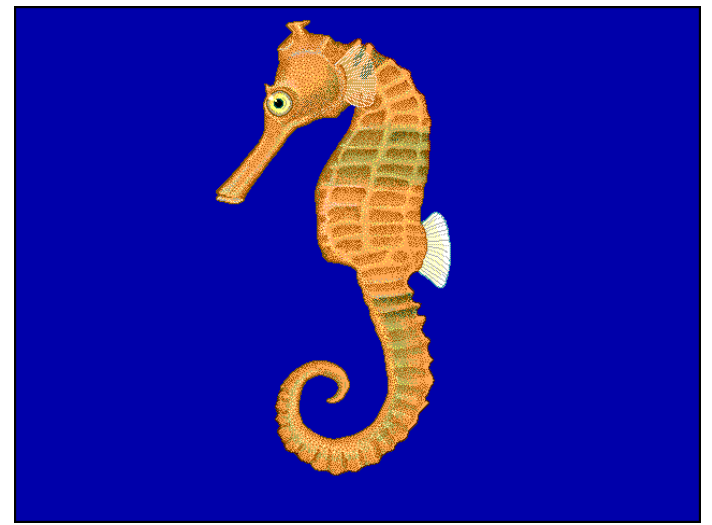

Computational Models of Neural Systems
Lecture 3.2

David S. Touretzky
September, 2019

Human Hippocampus

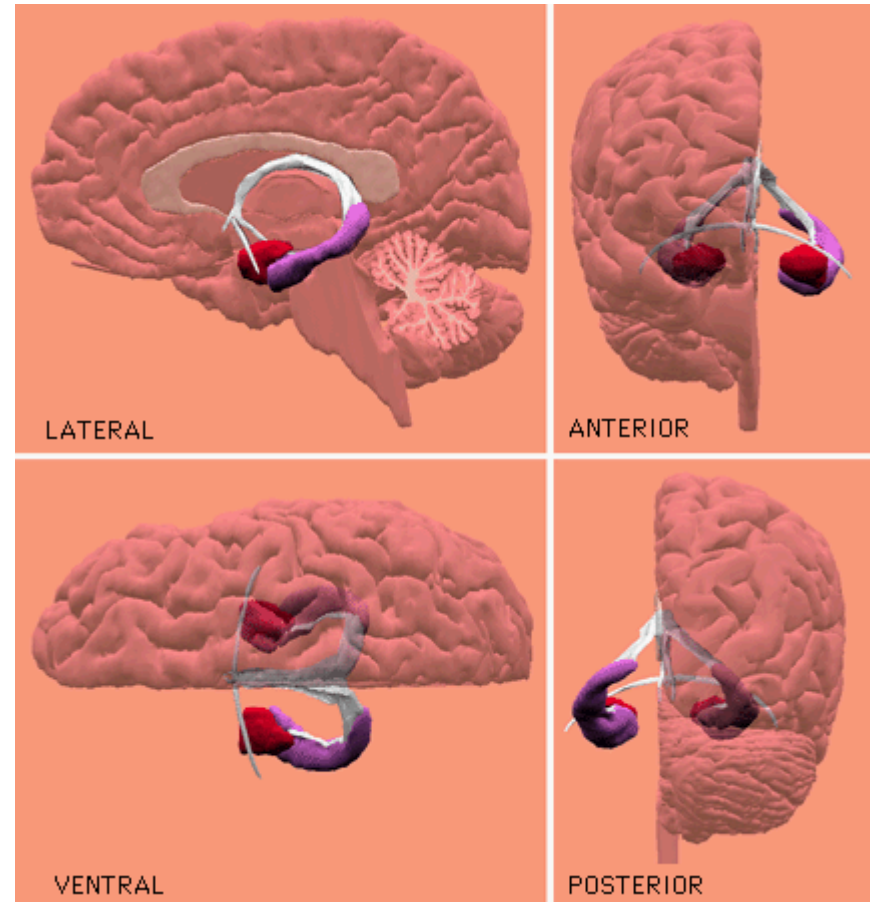
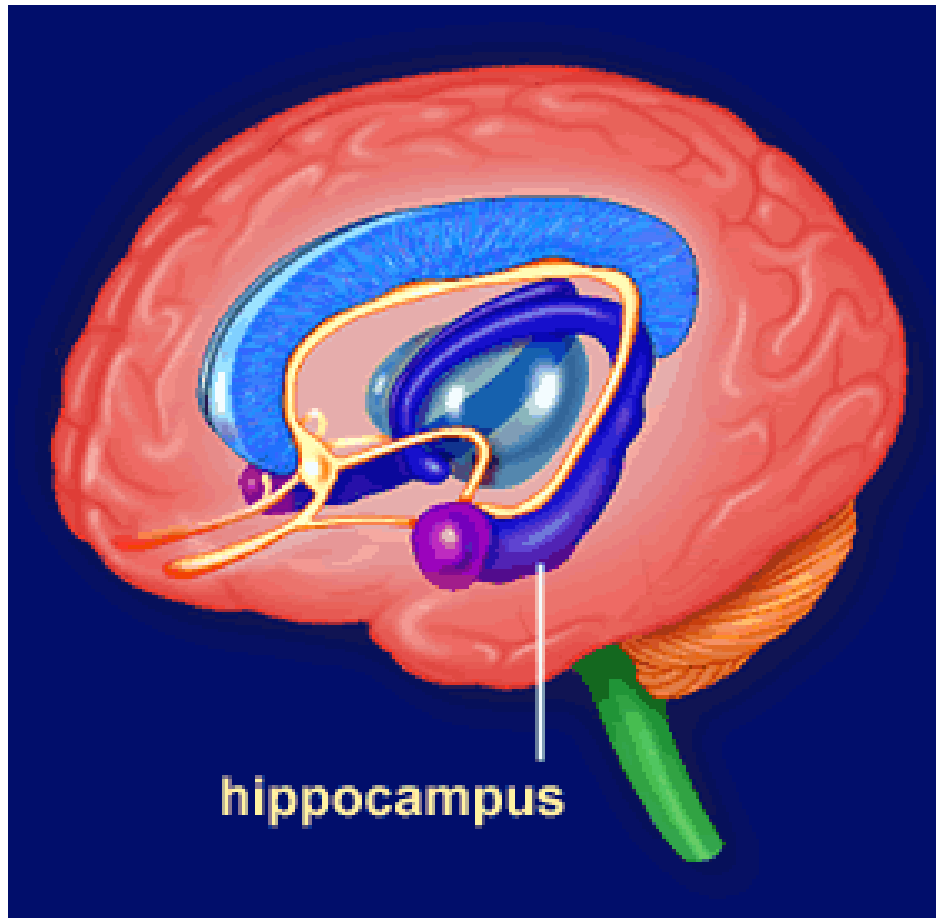

Human Hippocampus

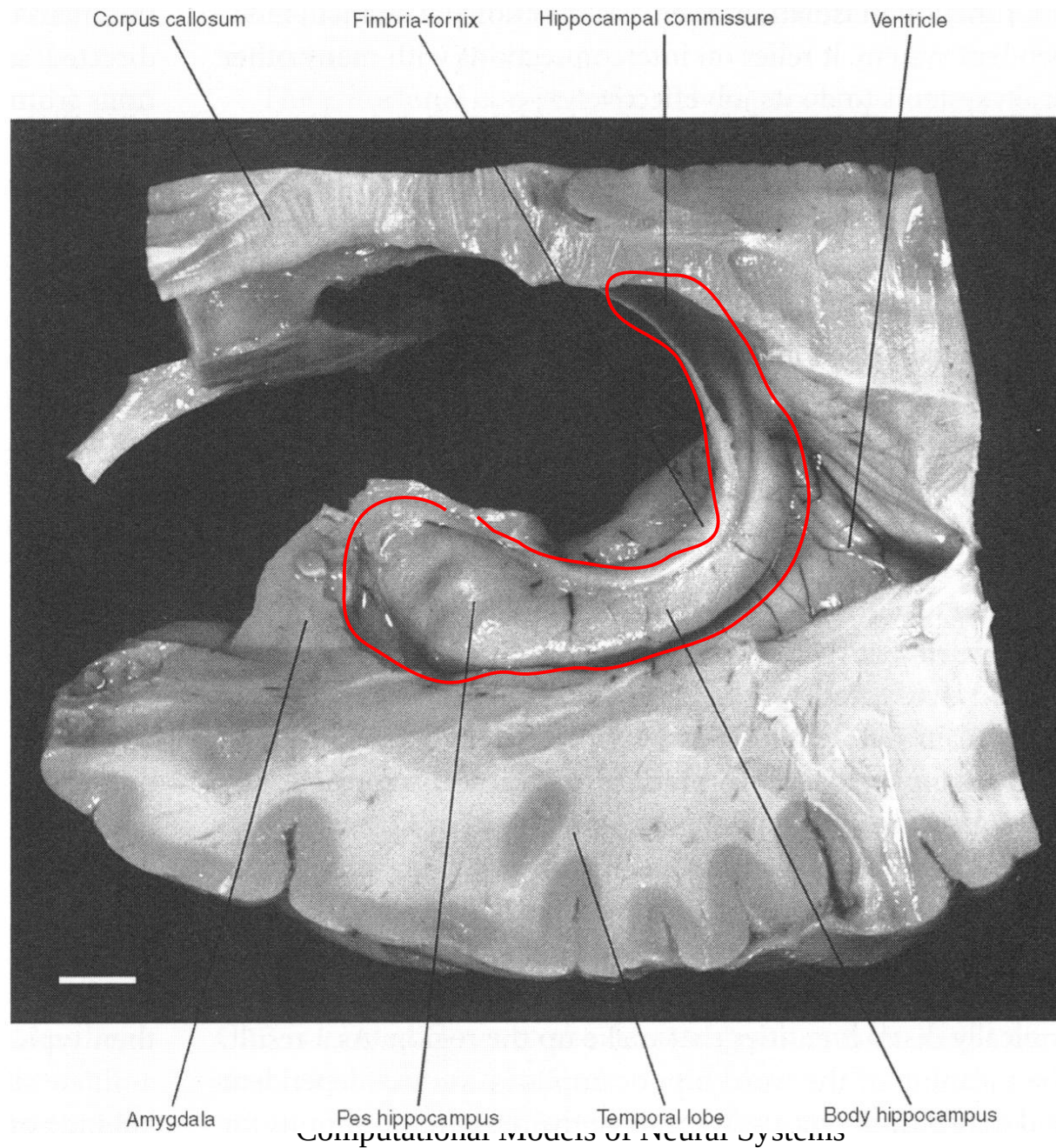

Hippocampus Means “Seahorse”

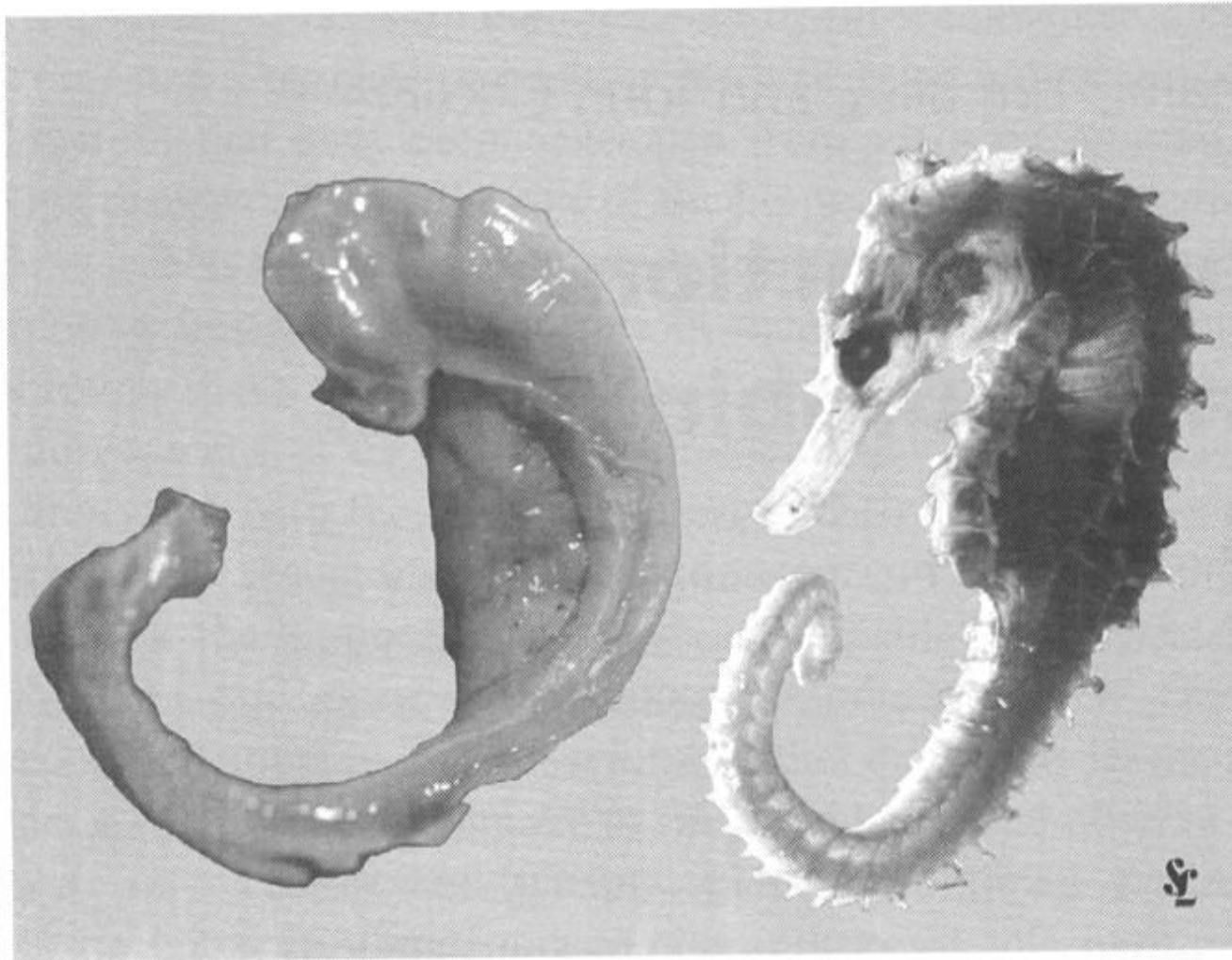

Dissected human hippocampus next to a specimen of *hippocampus leria*, one of several dozen species.

Rat Hippocampal Formation

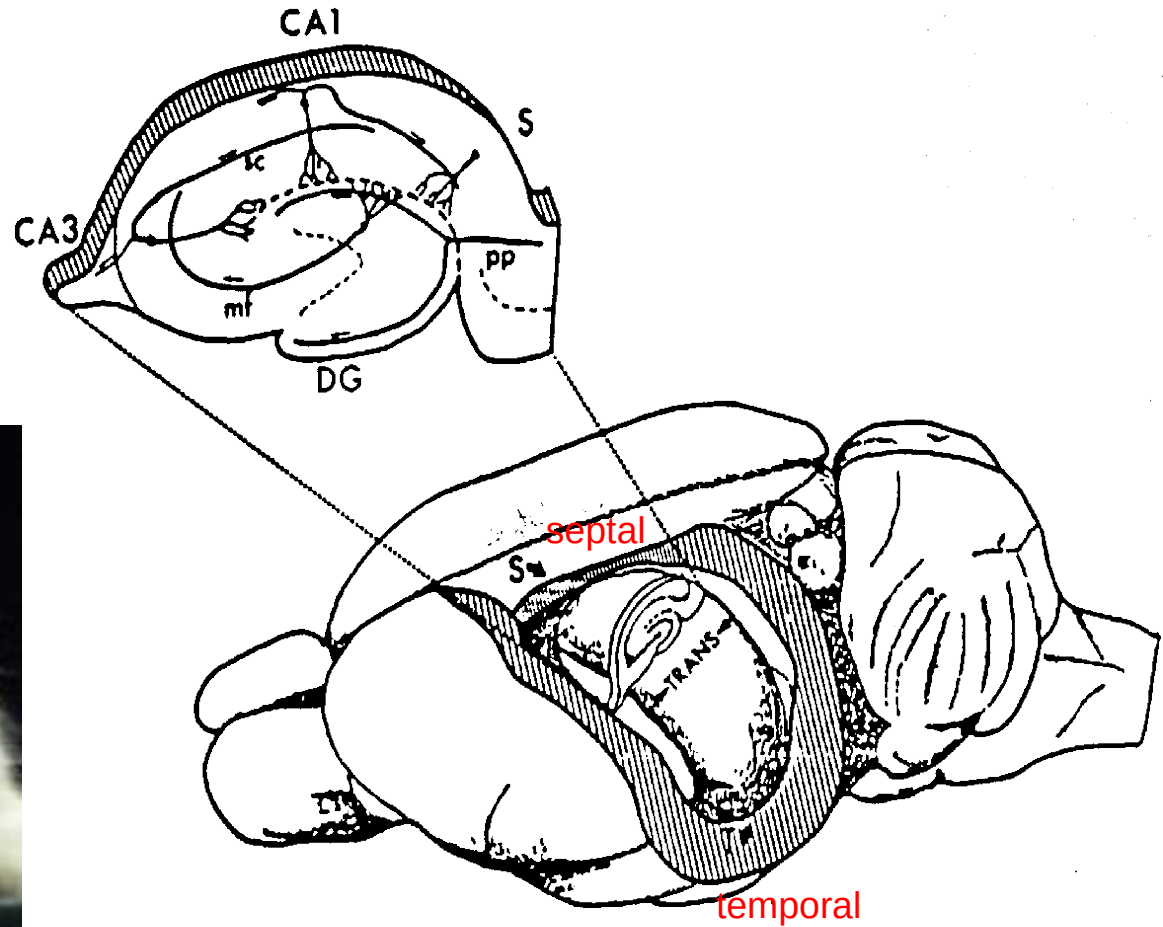
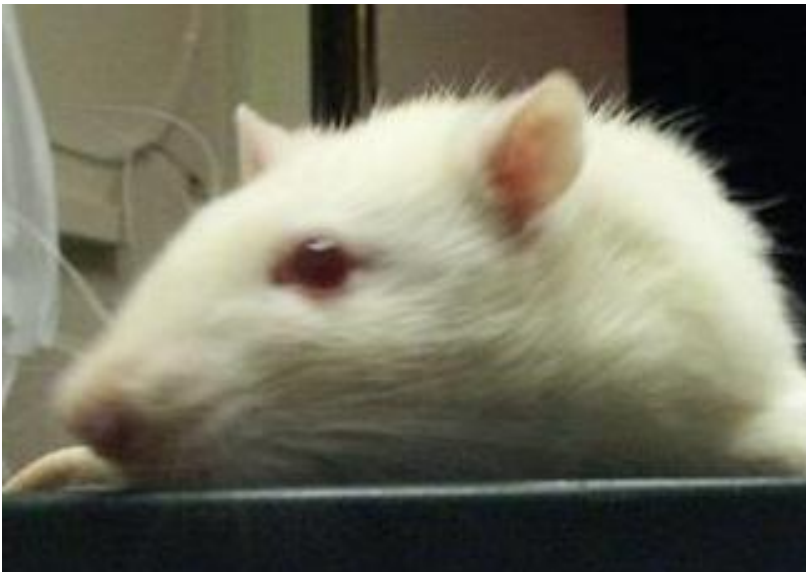

From (Amaral & Witter, 1989)

Ammon: Egyptian god with ram's horns



Rat Hippocampal Formation

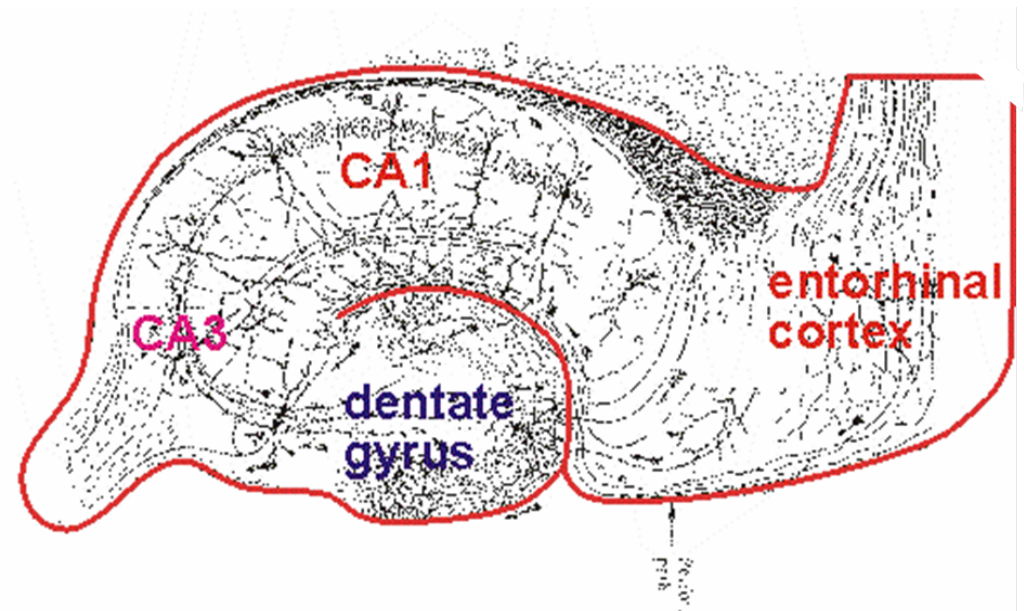
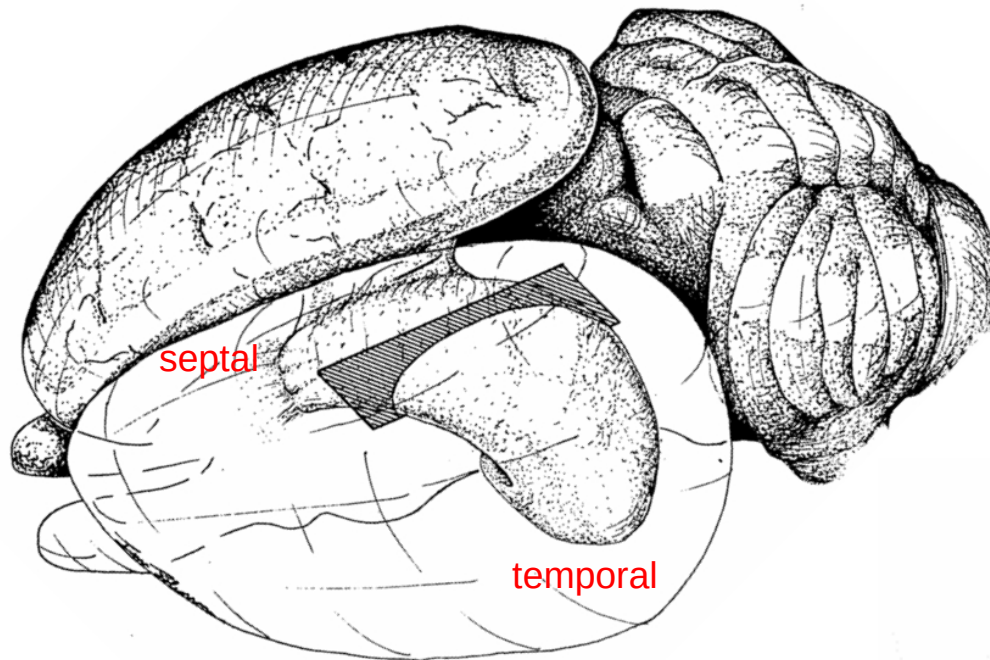

Components of Hippocampal Formation

- The “*hippocampus*” contains CA1 - CA3.

CA = Cornu Amonis (Ammon's horn)

- The “*hippocampal formation*” includes CA, dentate gyrus (“tooth-like bump”), entorhinal cortex, subiculum, pre- and parasubiculum.

- Hilus: reciprocally connected to DG.

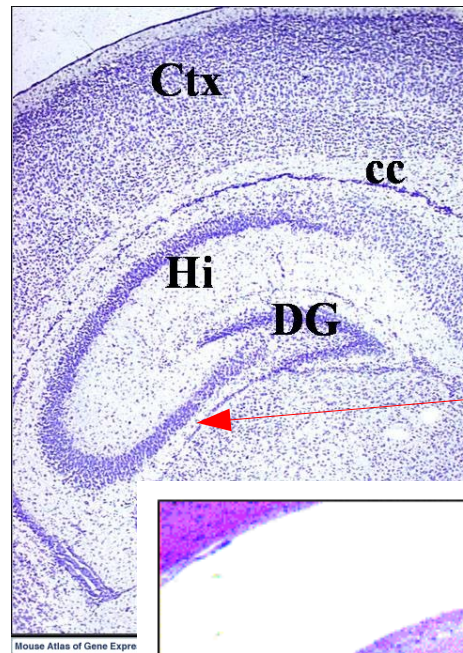

Ammon's Horn

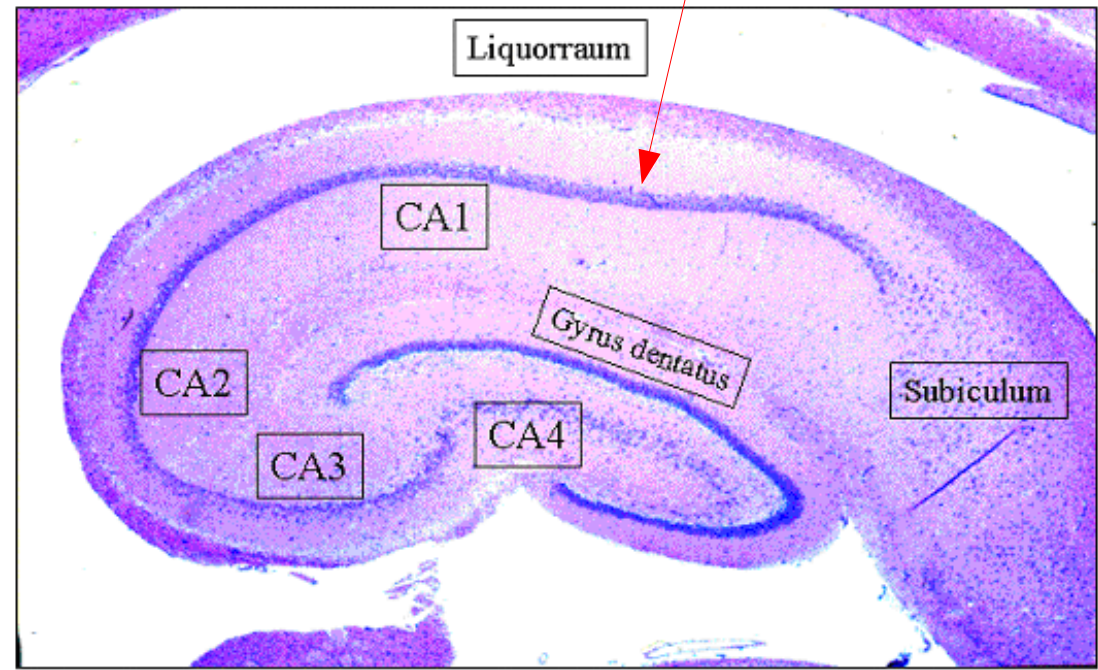

Cornu ammonis (=CA)

Early Anatomy: Cajal's Drawings

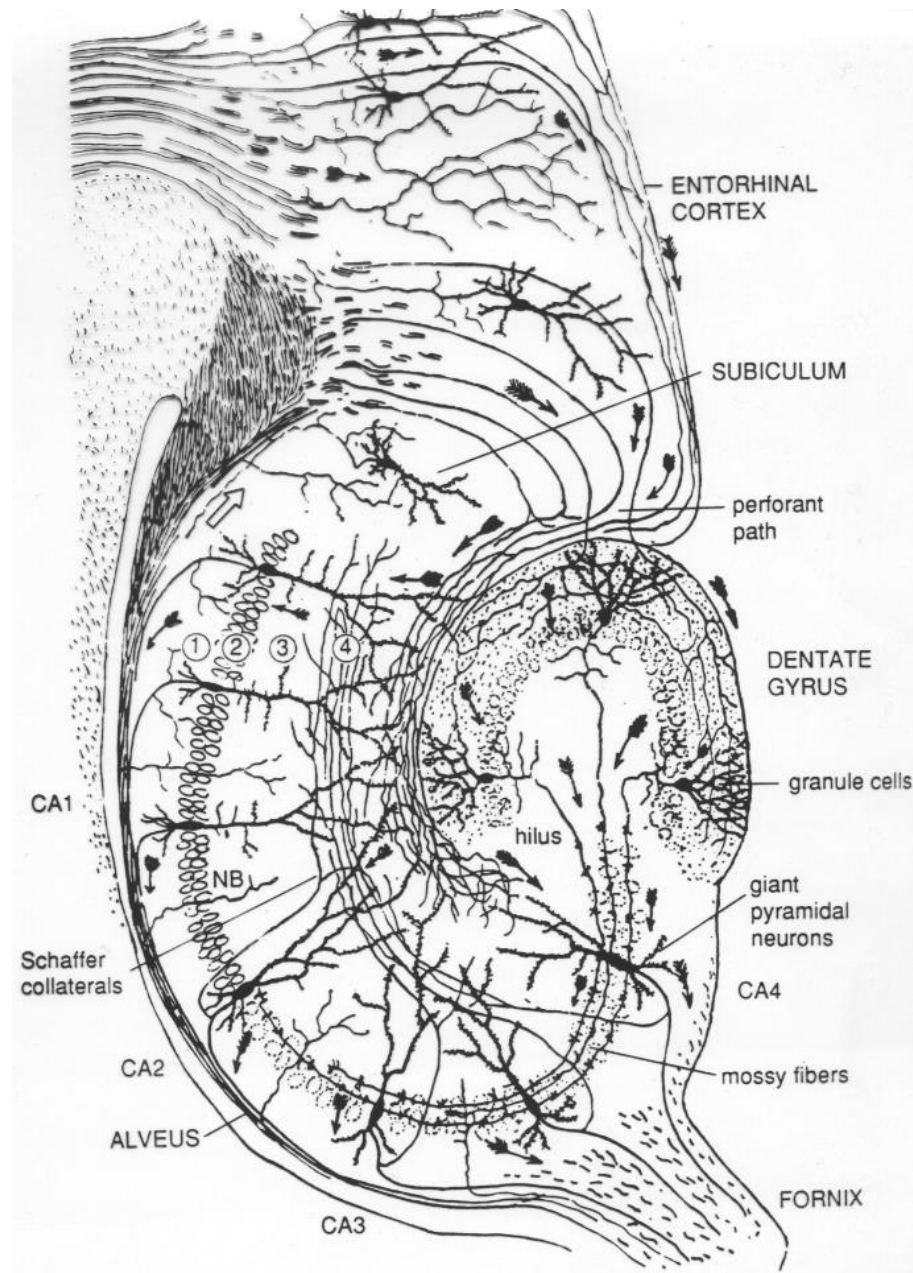

Rat Hippocampus

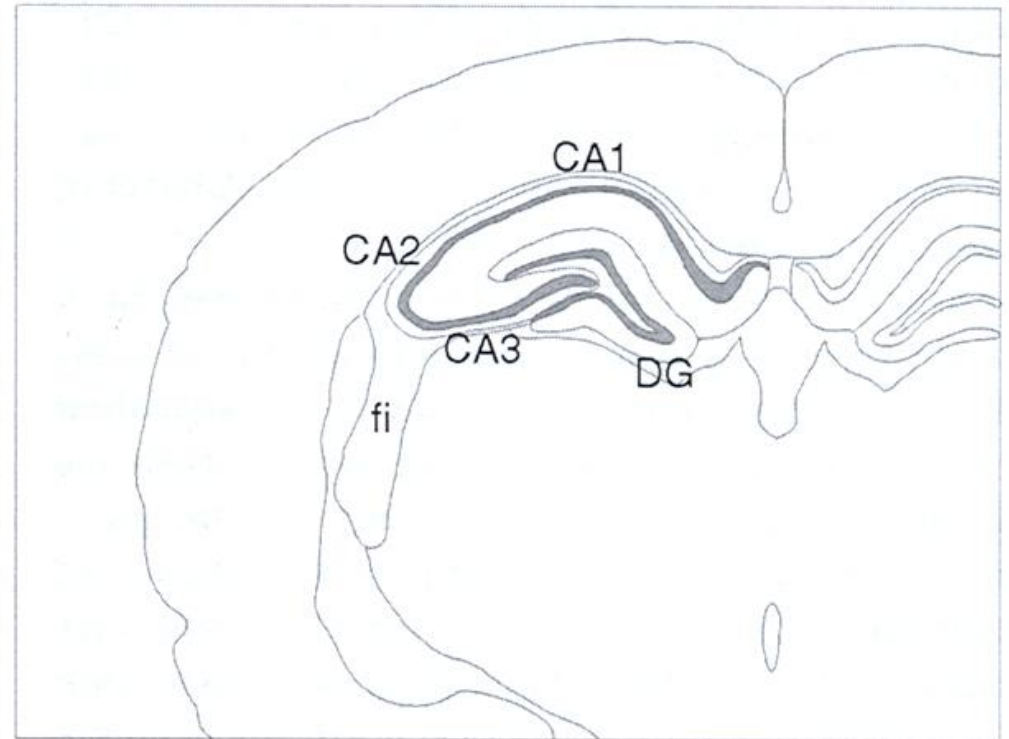

Monkey Hippocampus

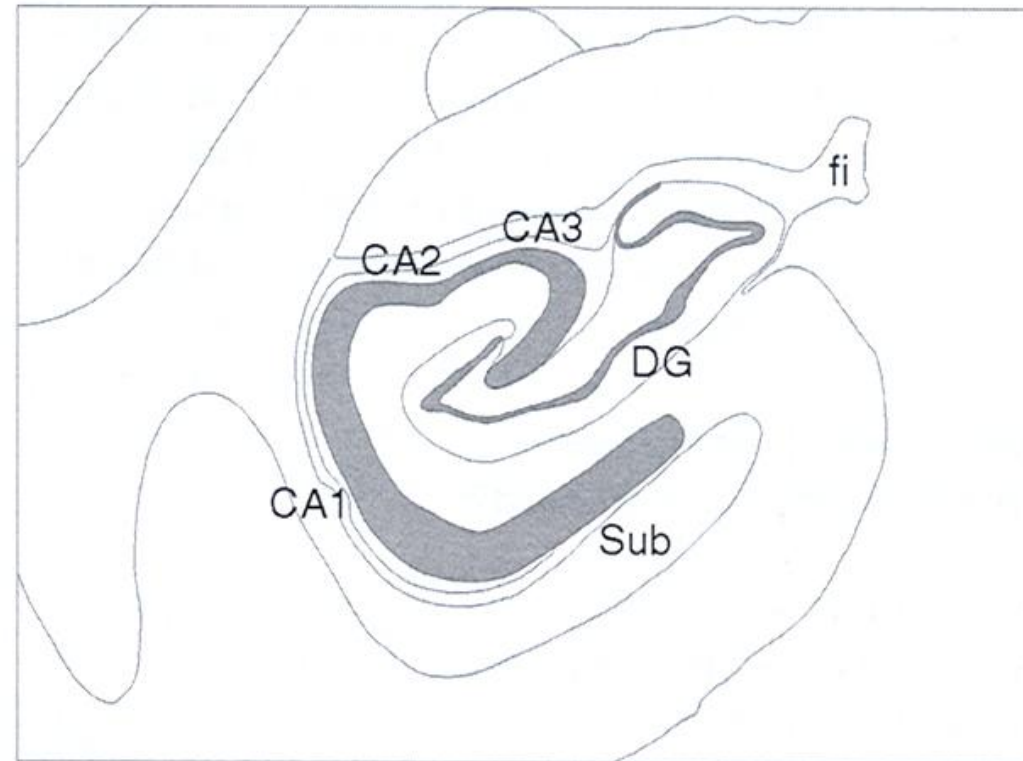
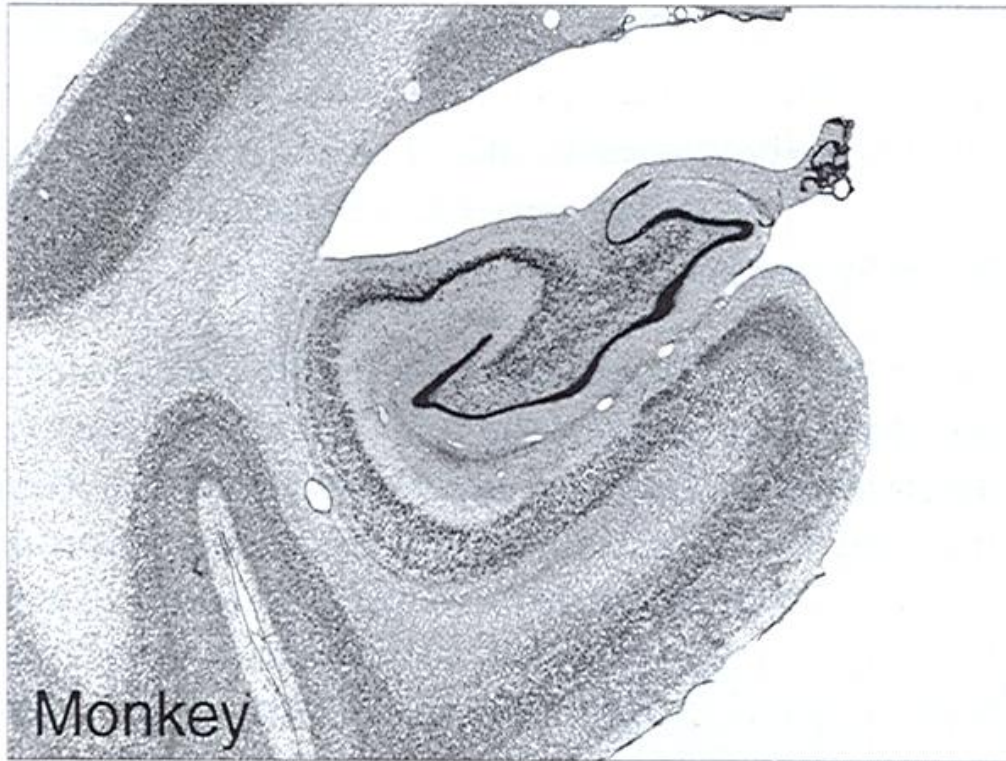

Human Hippocampus

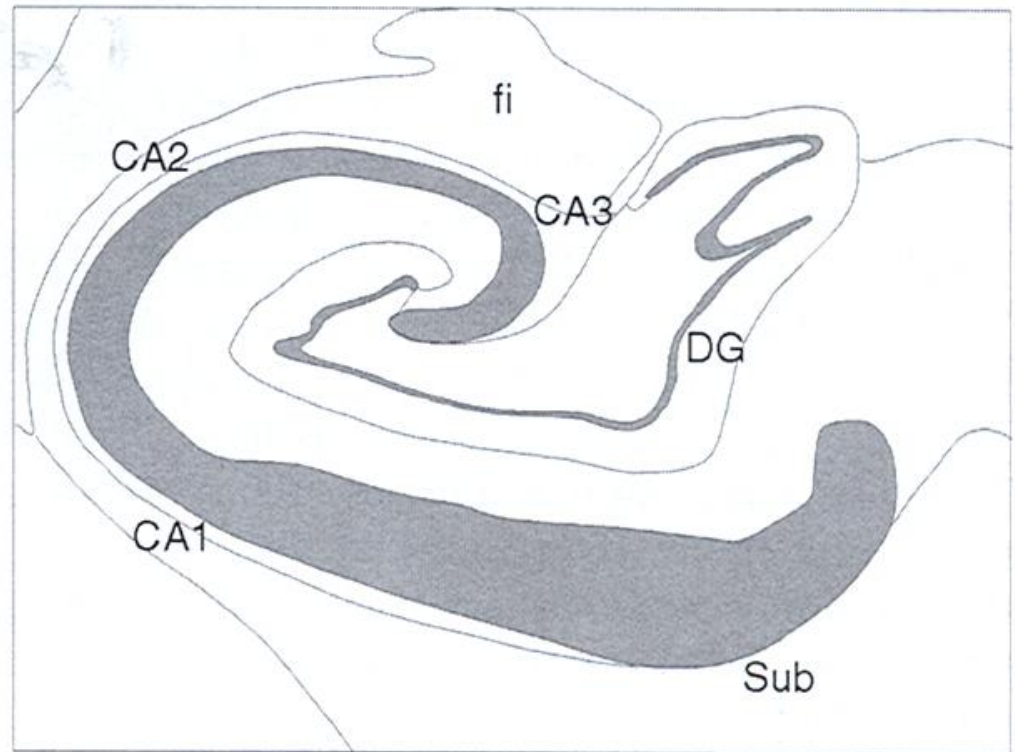
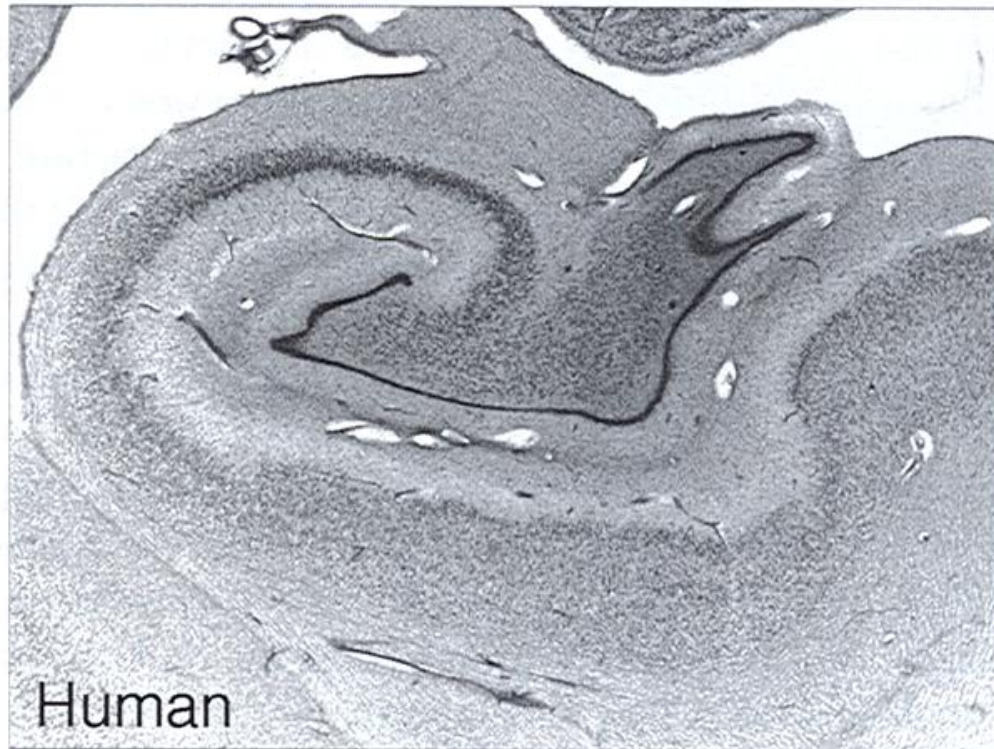

The volume of the human hippocampus is about 100 times that of the rat, and 10 times that of the monkey.

Basic Circuit

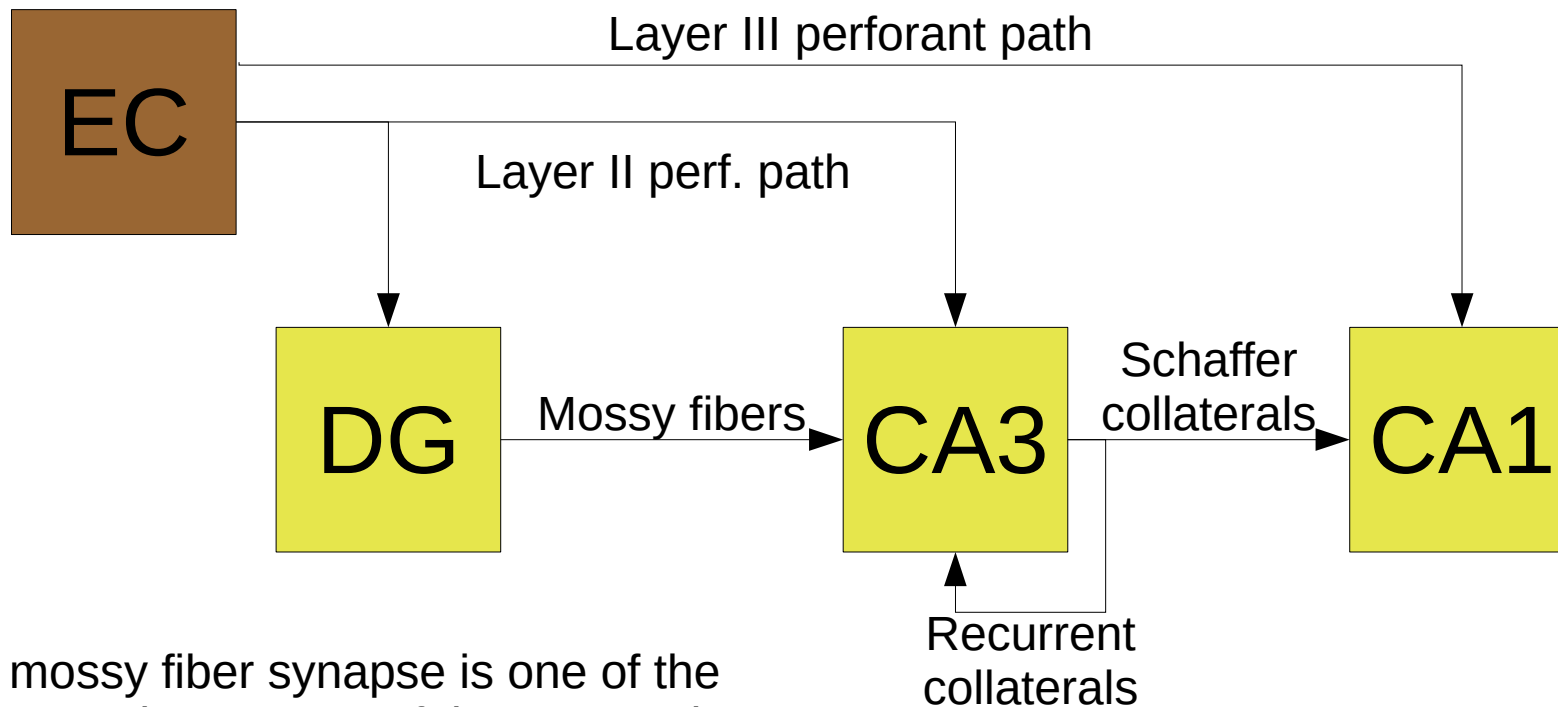

The mossy fiber synapse is one of the largest and most powerful synapses in the brain.

Connectivity Is Mostly Uni-Directional

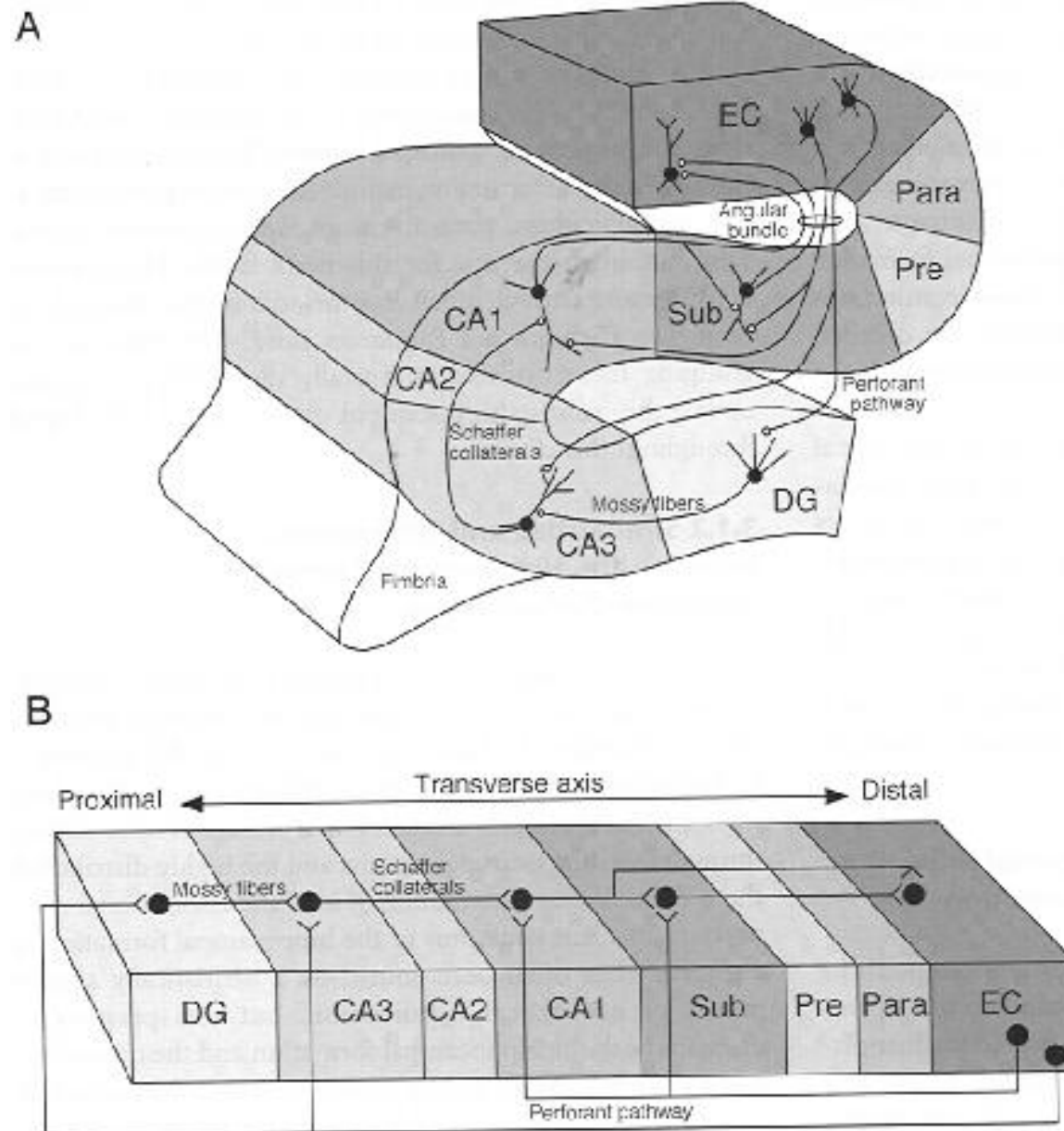

What About CA2?

- Small relative to CA3 and CA1
- Originally dismissed as a “transitional area”
- Driven by Schaffer collaterals from CA3
- Projects back to CA3 and to two layers of CA1
- Does not show activity-dependent LTP as found in CA3 and CA1
- In mice, contributes to social memory

A CA2 in Context

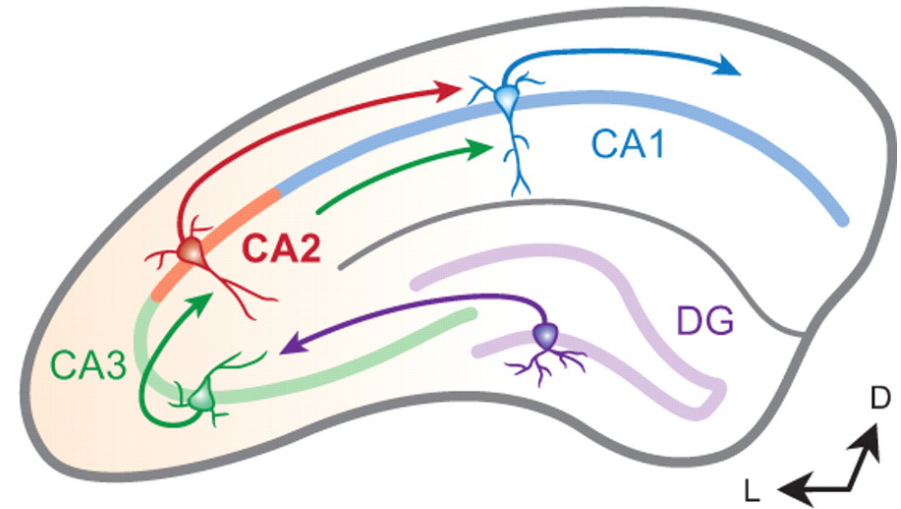

B

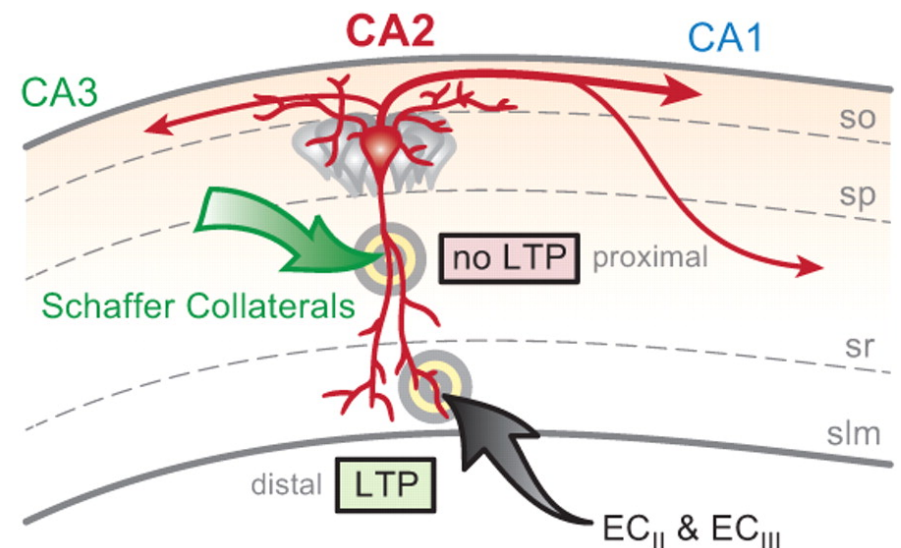

Caruana, Alexander, and Dudek (2012), Fig. 1

More of the Picture

- EC: entorhinal cortex
 - Layer II projects to DG/CA3
 - Layer III projects to CA1/Sub
 - CA1 & Sub project back to EC layer V
- DG: dentate gyrus
 - mossy fibers project to CA
- CA3
 - Schaffer collaterals to CA1
- Sub: subiculum

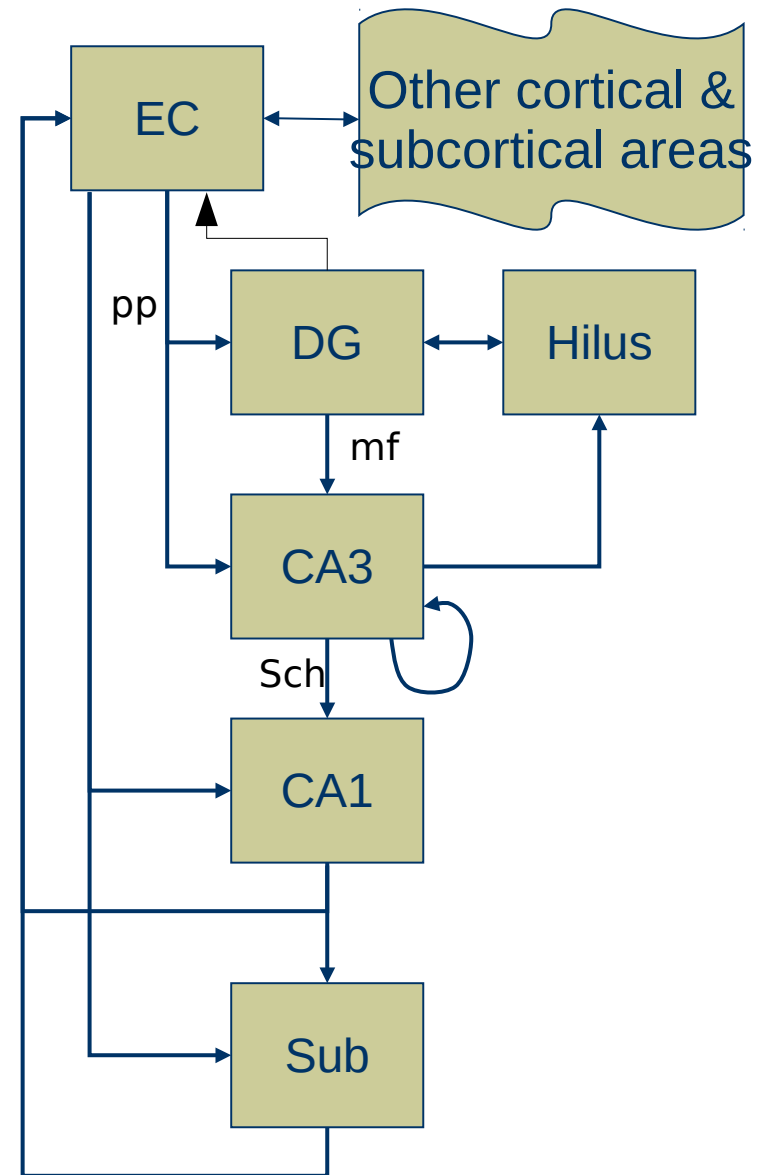

Even More

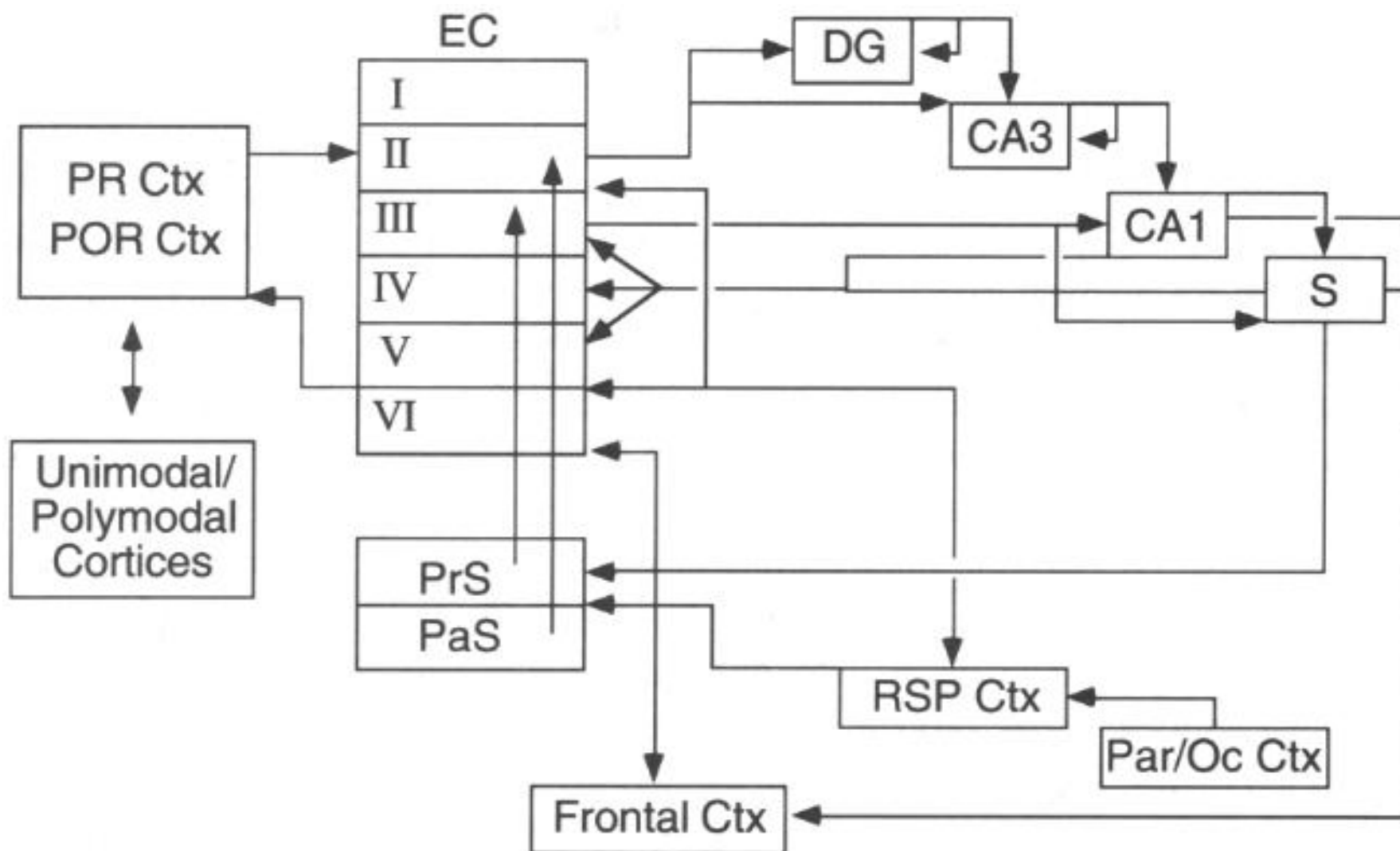

PR: perirhinal cortex; POR: postrhinal cortex; EC: entorhinal cortex; PrS: presubiculum; PaS: parasubiculum; DG: dentate gyrus; CA: Cornu amonis; S: subiculum; RSP: retrosplenial cortex; Par/Oc: parietal/occipital cortex

Three Major Fiber Systems

- Angular bundle from EC: perforant path (and more)
- Fimbria/fornix to subcortical areas
 - fimbria: red
 - fornix: yellow
- Dorsal and ventral commissures link hippocampi
 - dorsal: purple
 - ventral: green

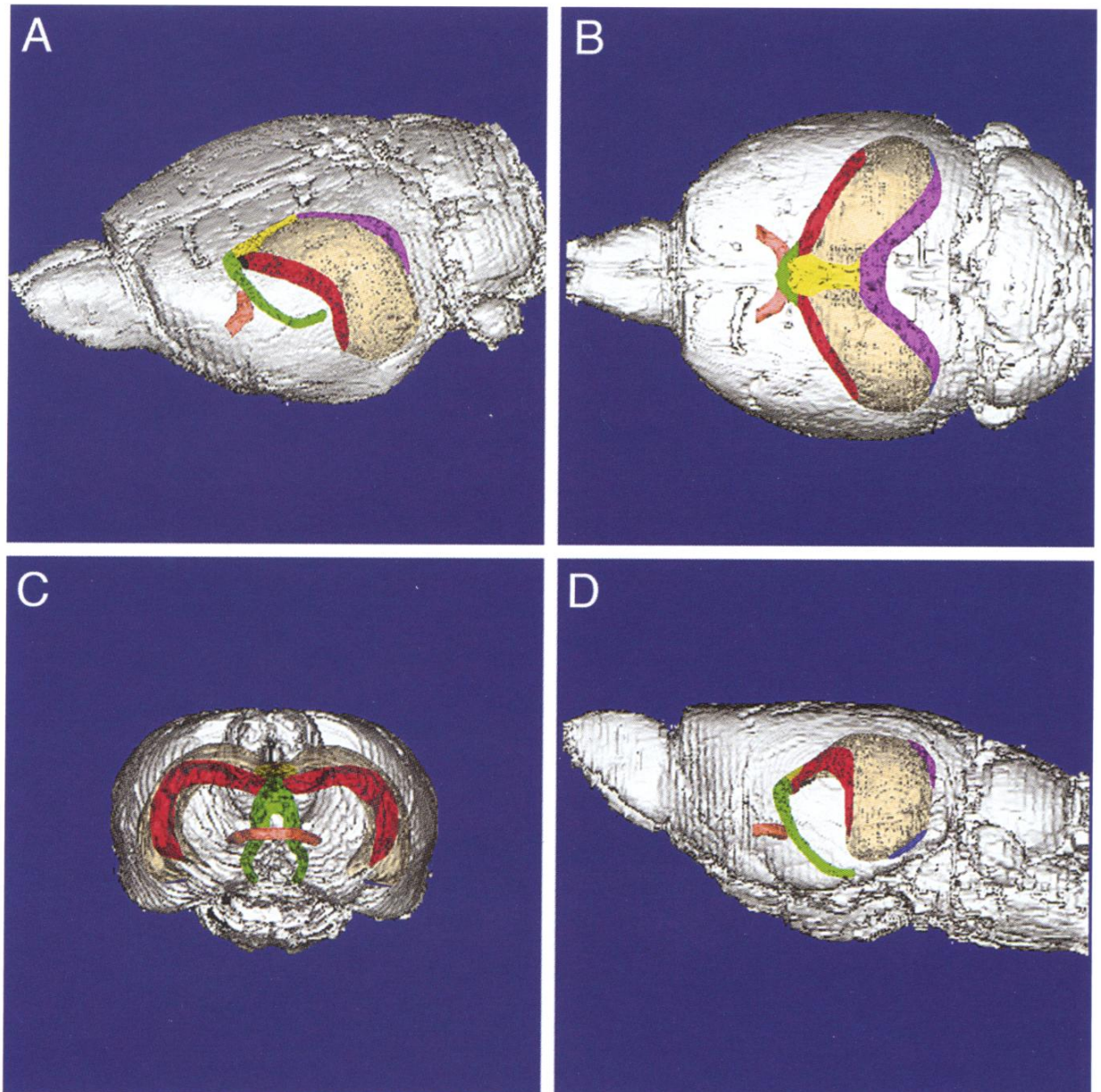

Alveus/Fimbria/Fornix

- Second input/output pathway for hippocampus (first is via angular bundle from EC)
- Communicates with subcortical structures: septal nuclei and mammillary bodies

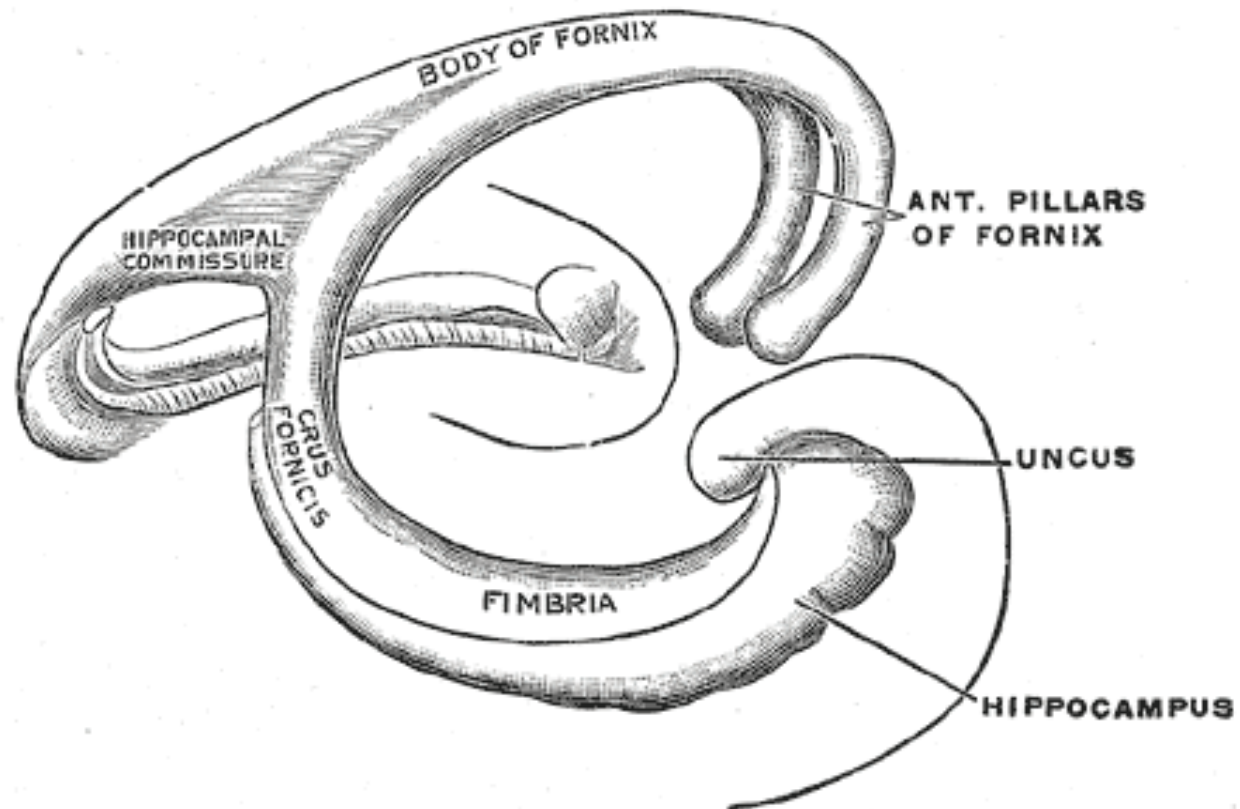

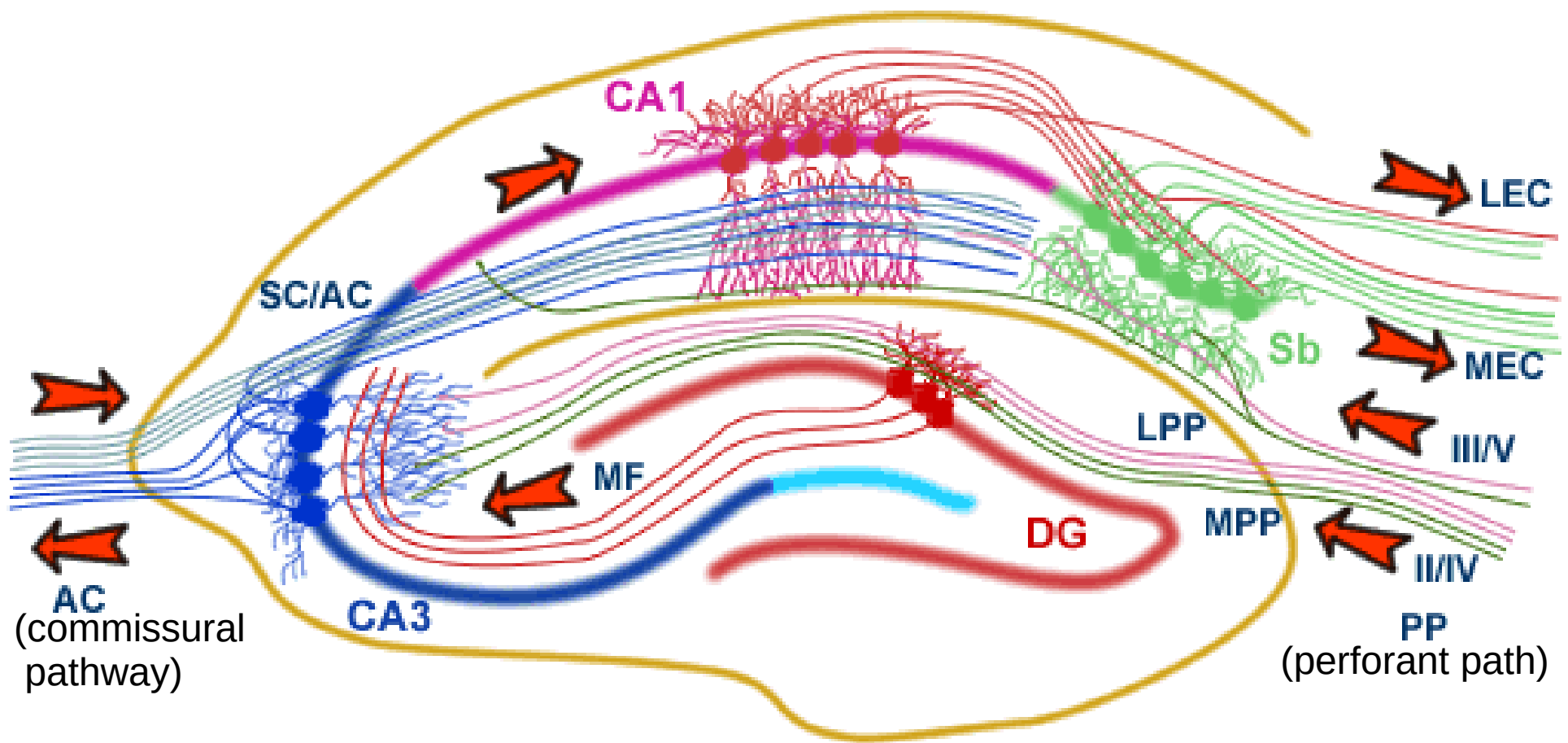

The Hippocampal Network: The hippocampus forms a principally uni-directional network, with input from the Entorhinal Cortex (EC) that forms connections with the Dentate Gyrus (DG) and CA3 pyramidal neurons via the Perforant Path (PP - split into lateral and medial). CA3 neurons also receive input from the DG via the mossy fibres (MF). They send axons to CA1 pyramidal cells via the Schaffer Collateral Pathway (SC), as well as to CA1 cells in the contralateral hippocampus via the Associational Commissural pathway (AC). CA1 neurons also receive input directly from the Perforant Path and send axons to the Subiculum (Sb). These neuron in turn send the main hippocampal output back to the EC, forming a loop.

Dendritic Arborization of Principal Cells

Figure 3-15. Dendritic arborization of the principal cells in the rat dentate gyrus (granule cells) and hippocampus proper (pyramidal cells). See the text for details.

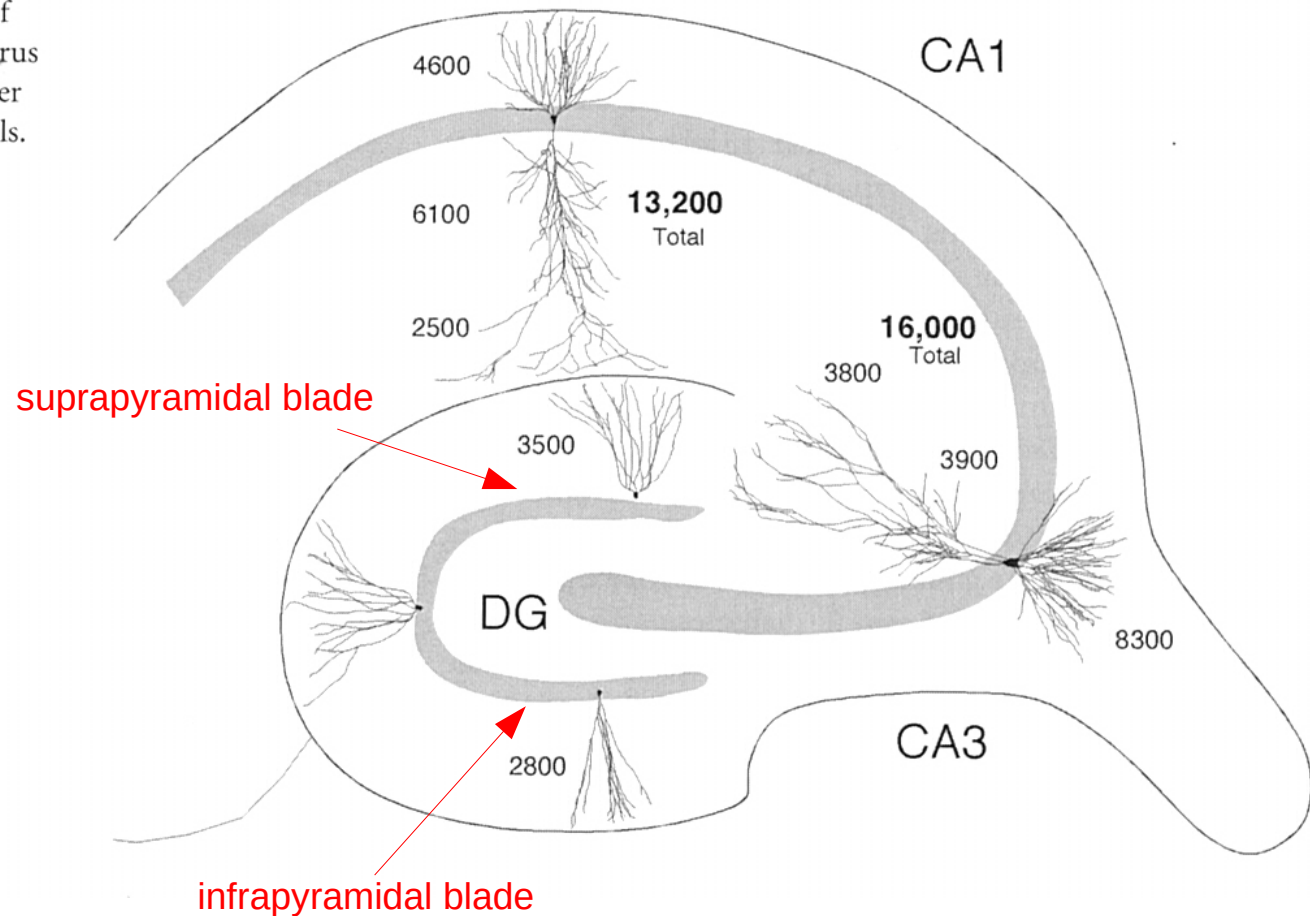

Structure of the Dentate Gyrus

- Granule cell layer holds principal cell bodies
 - their axons form the mossy fiber pathway
- Molecular layer: gc dendritic tree; afferent connections
- Polymorphic cell layer (hilus): interneurons, mf collaterals

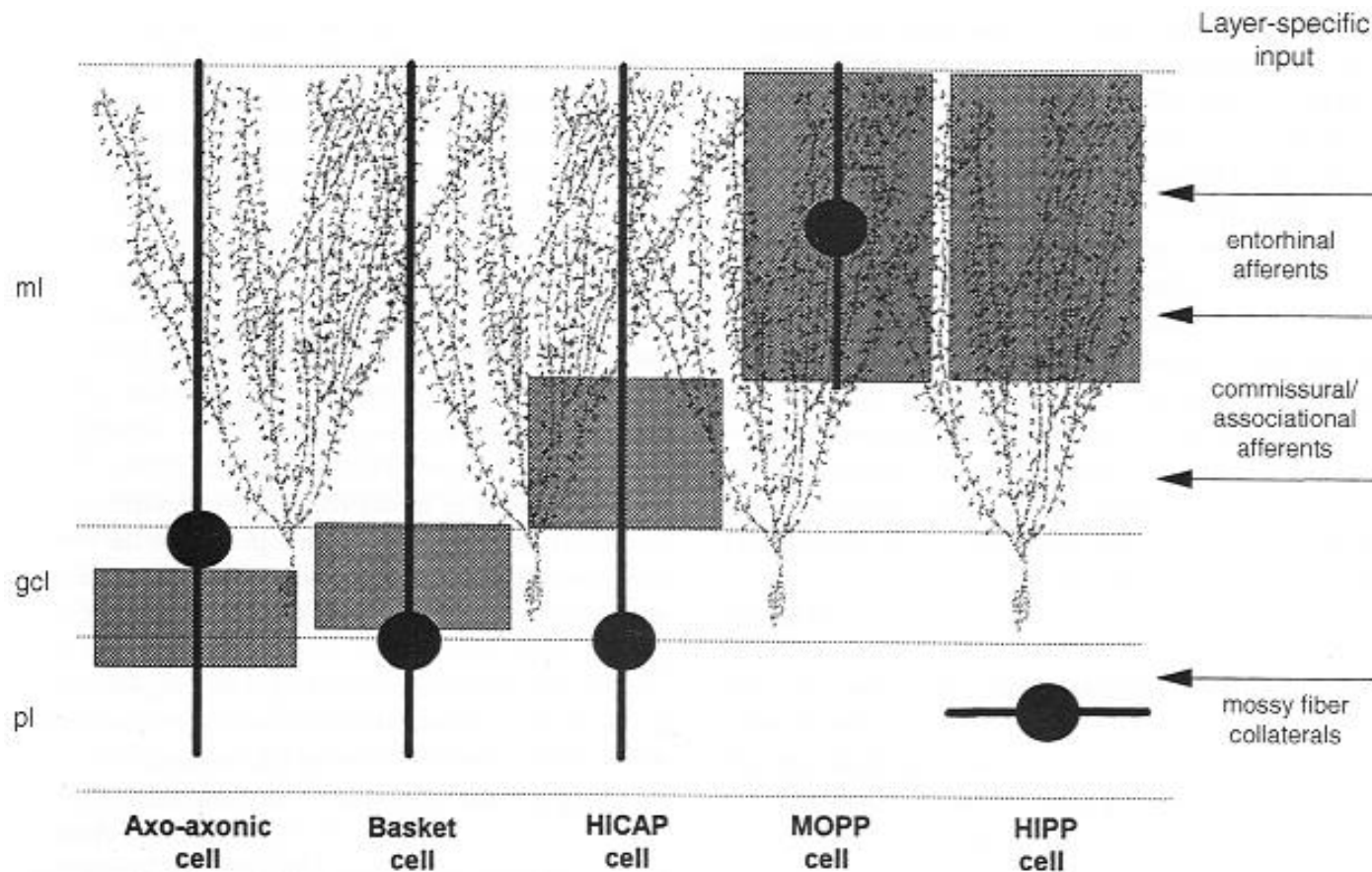

Mossy Fiber Synapse Onto CA3 Cells

- The dentate gyrus projection to CA3 terminates in large mossy fiber synapses.
- CA3 dendrites have “thorny excrescences” with complex spine shapes. A mossy fiber can make 30-40 synapses within one excrescence.
- Each granule cell contacts only about 15 CA3 pyramidal cells. Each pyramidal cell receives input from only about 72 granule cells.

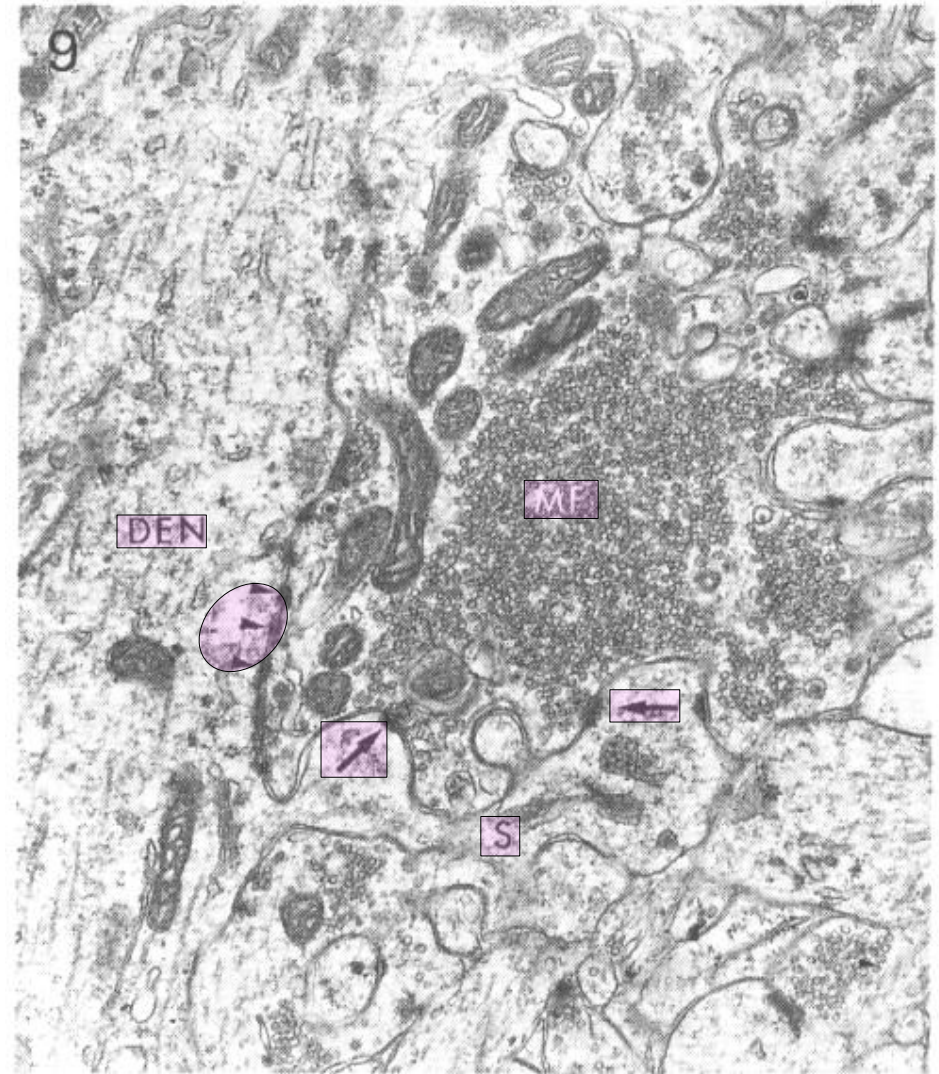

Structure of CA3

CA3 pyramidal cell

- stratum radiatum: entorhinal afferents; mossy fibers enter from DG, make synapses in s. lucidum
- stratum lucidum
- stratum pyramidale
- stratum oriens: recurrent collaterals

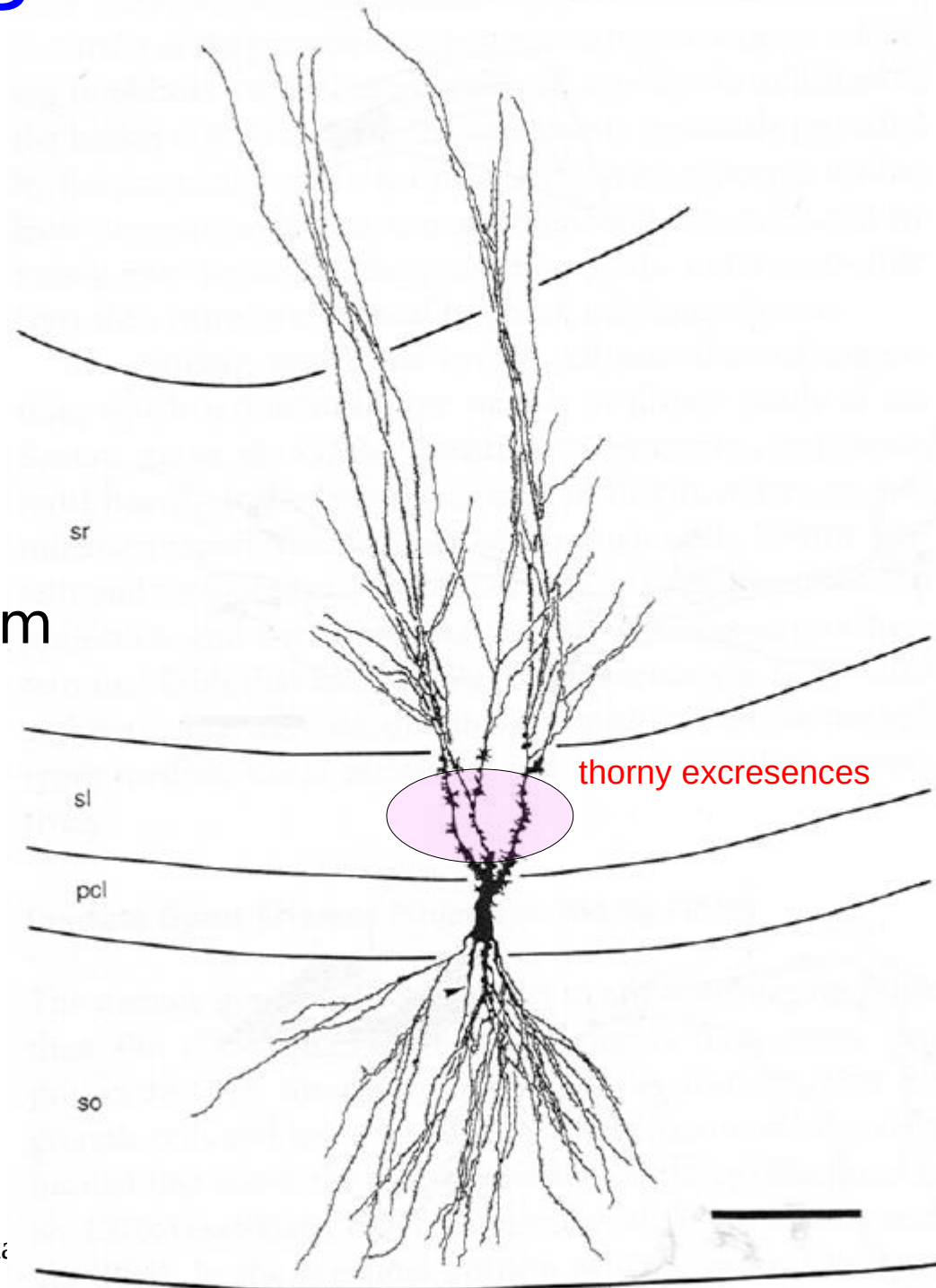

Structure of CA1

- stratum lacunosum-moleculare: entorhinal afferents
- stratum radiatum: Schaeffer collaterals, commissural fibers
- stratum pyramidale
- stratum oriens

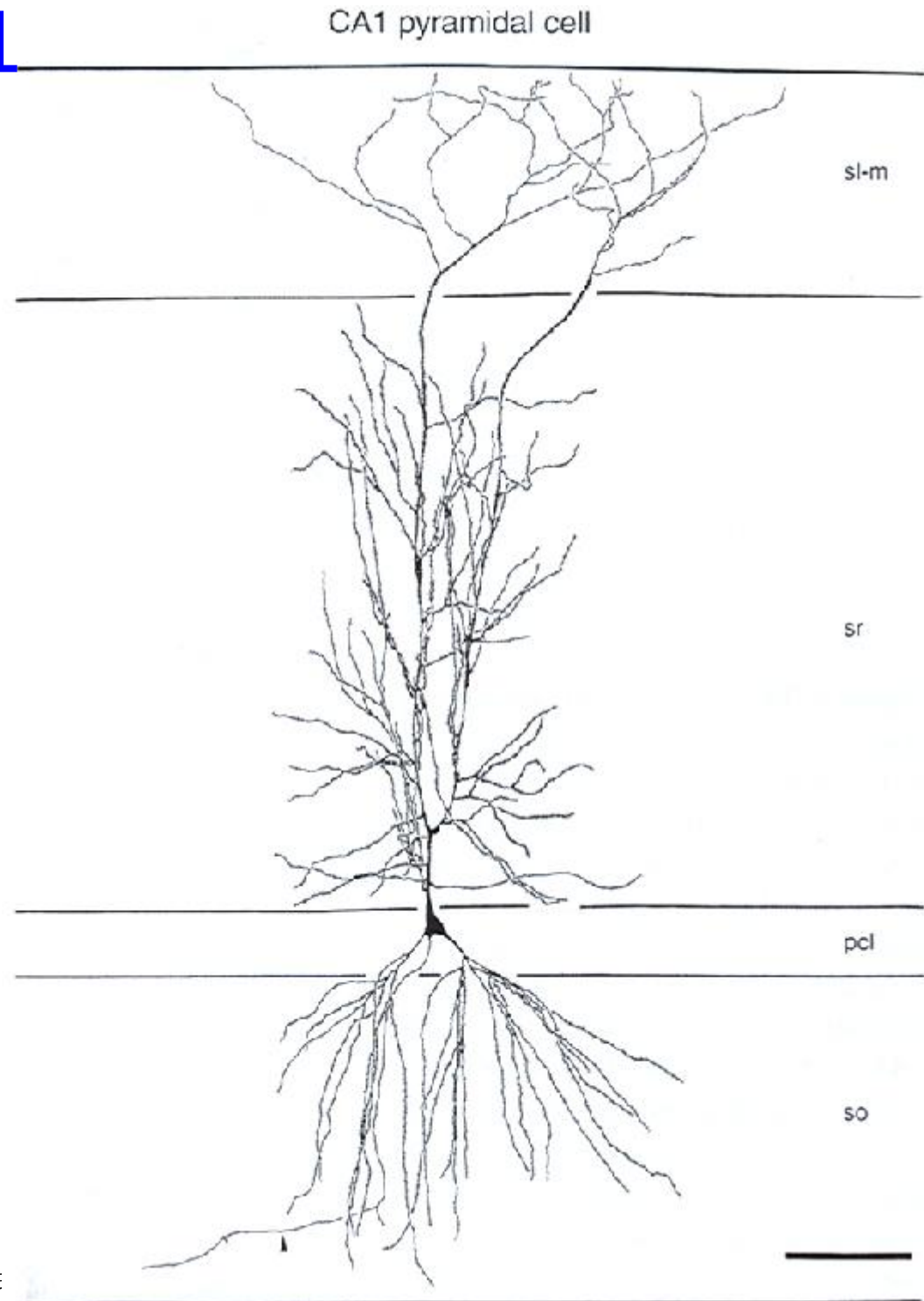

Interneurons in CA3/CA1

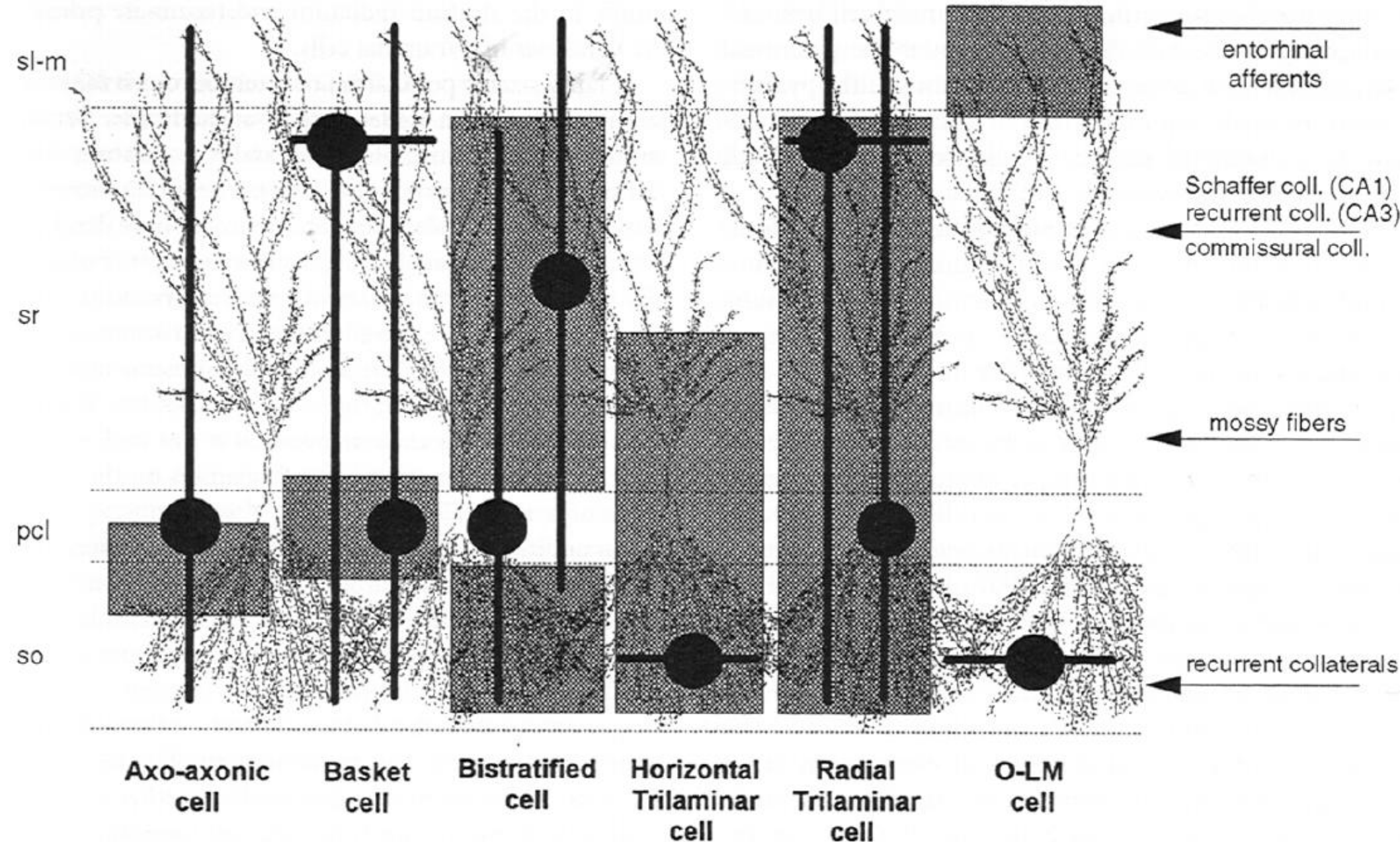

Structured Projections: EC Layer II vs. III

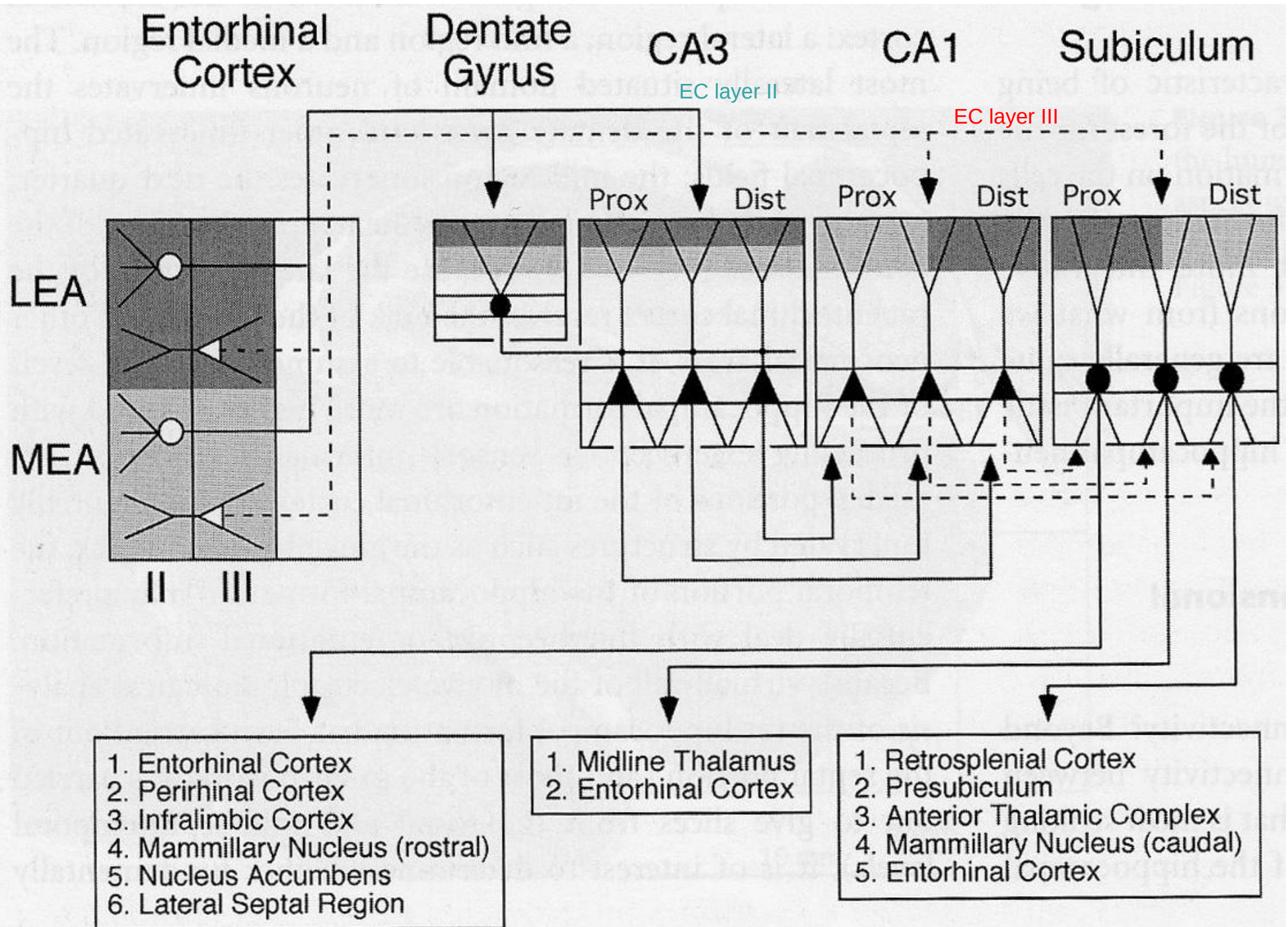

Layer II Projections

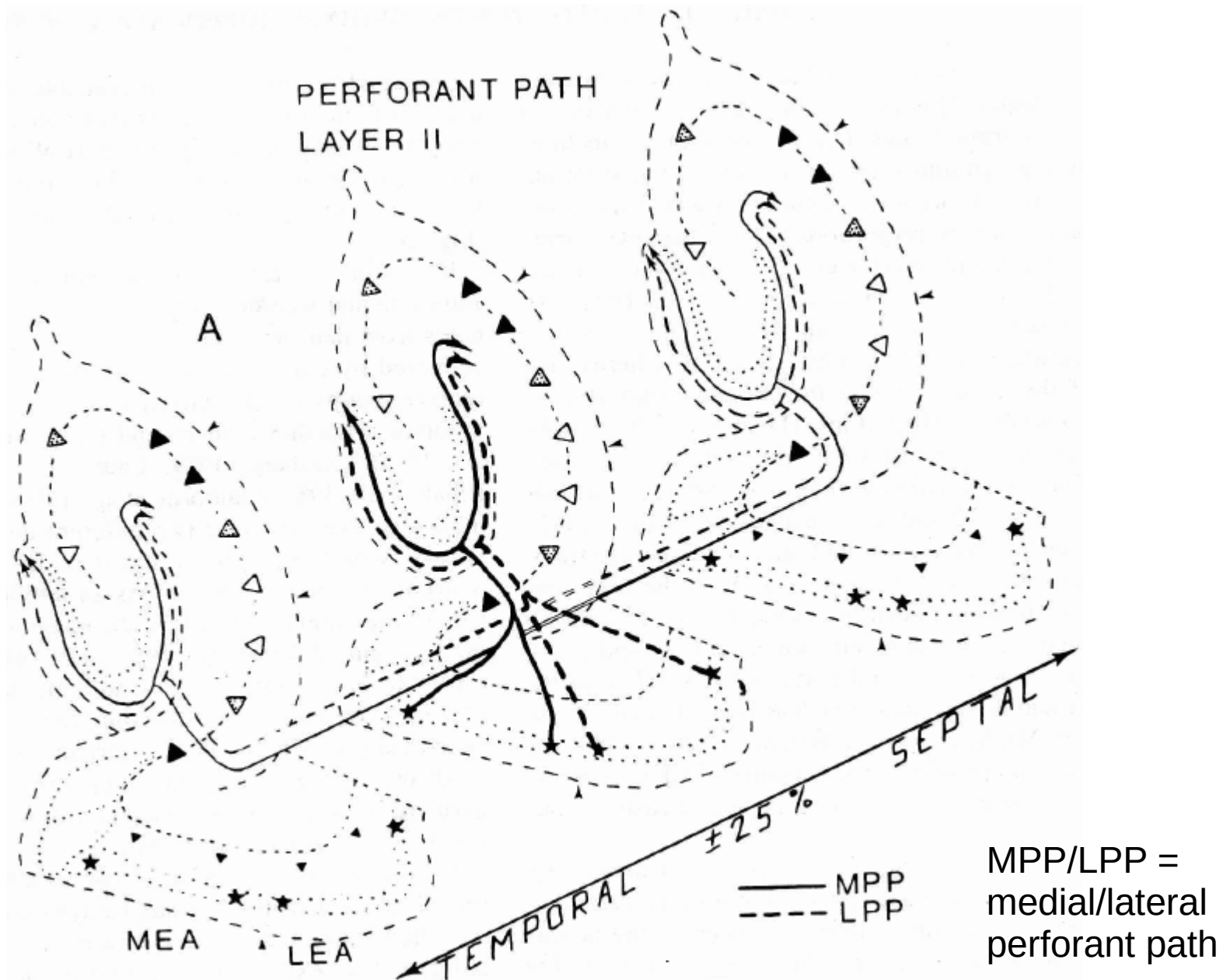

Layer III Projections

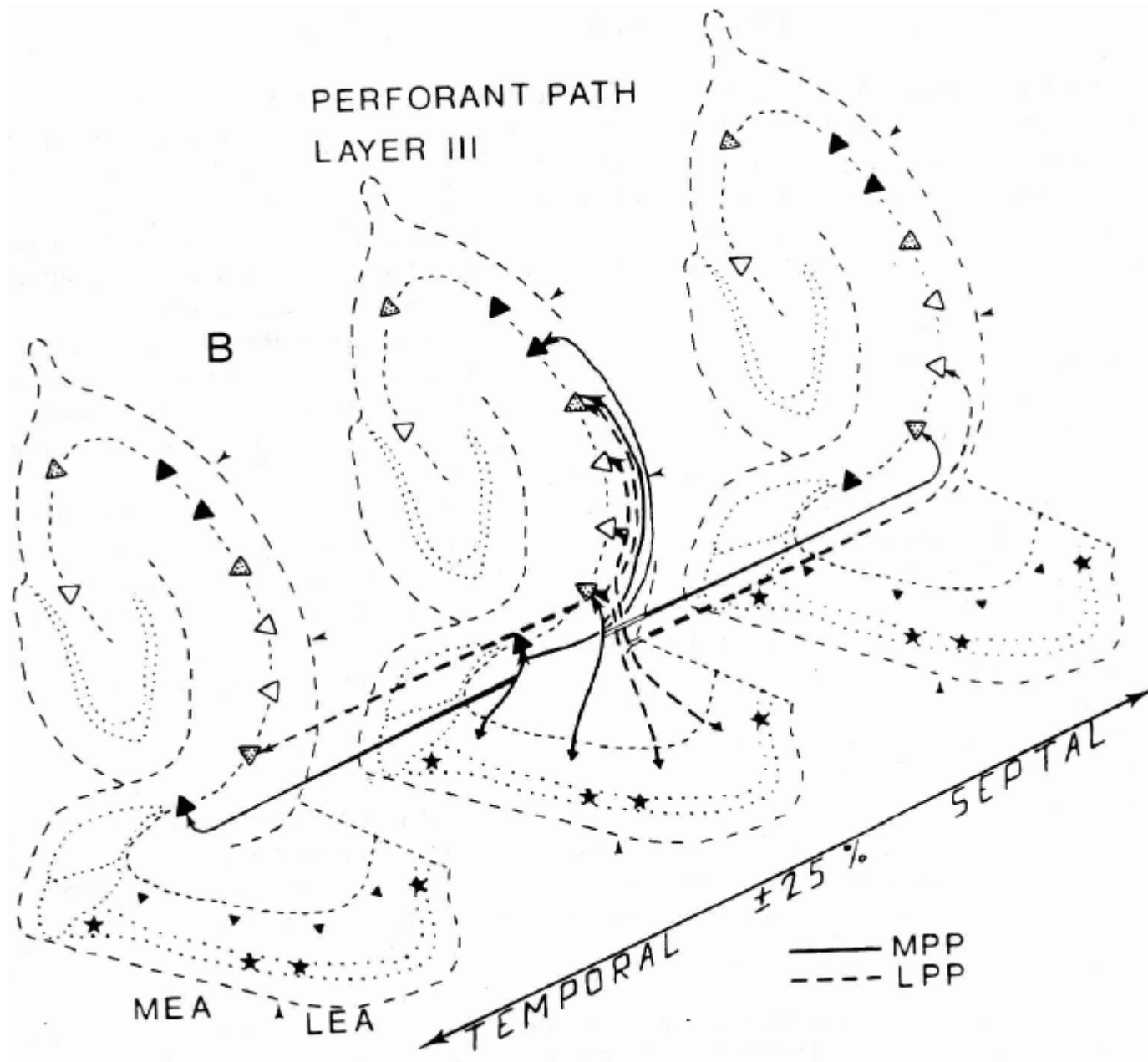

Temporal-Lobe.com

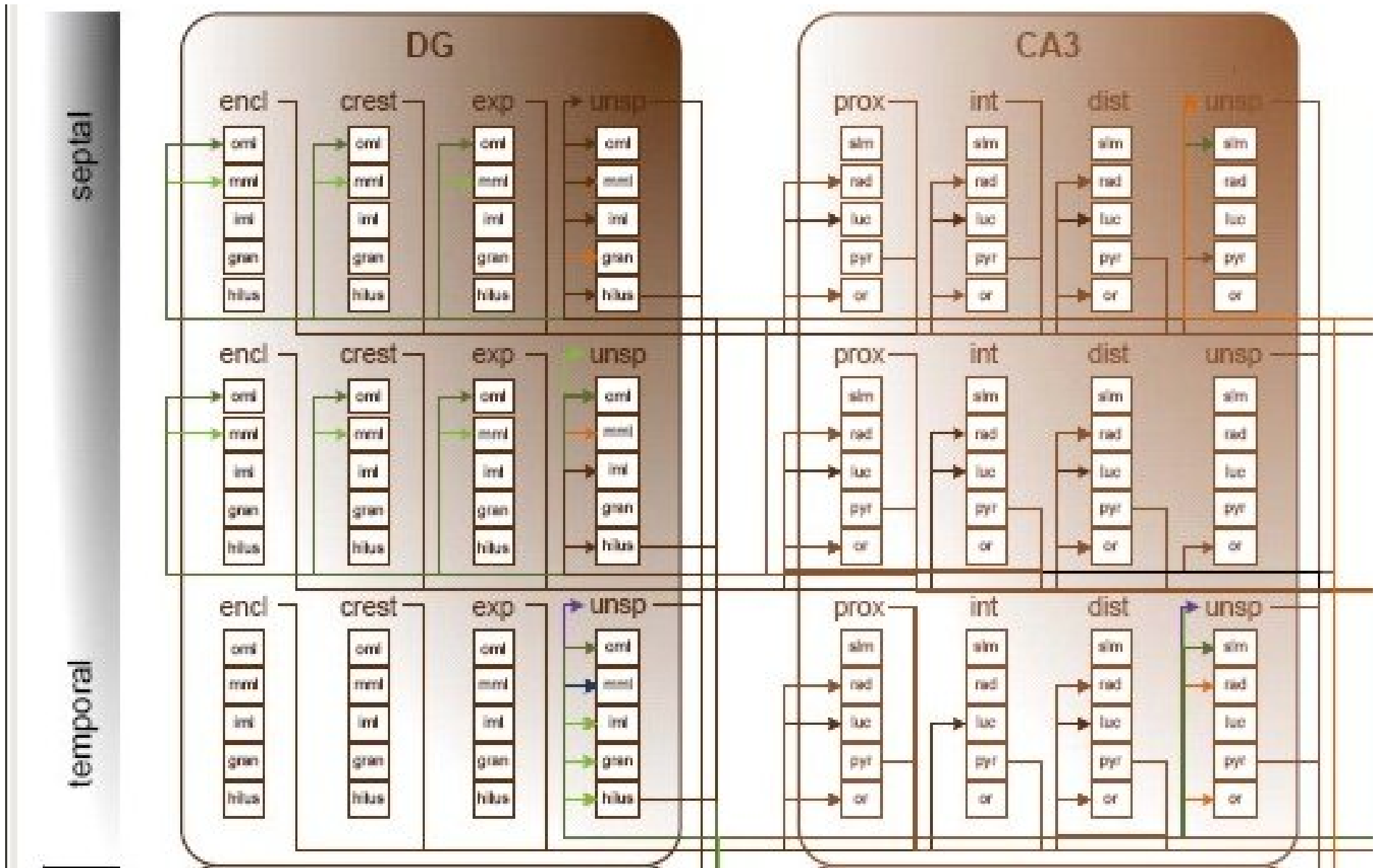

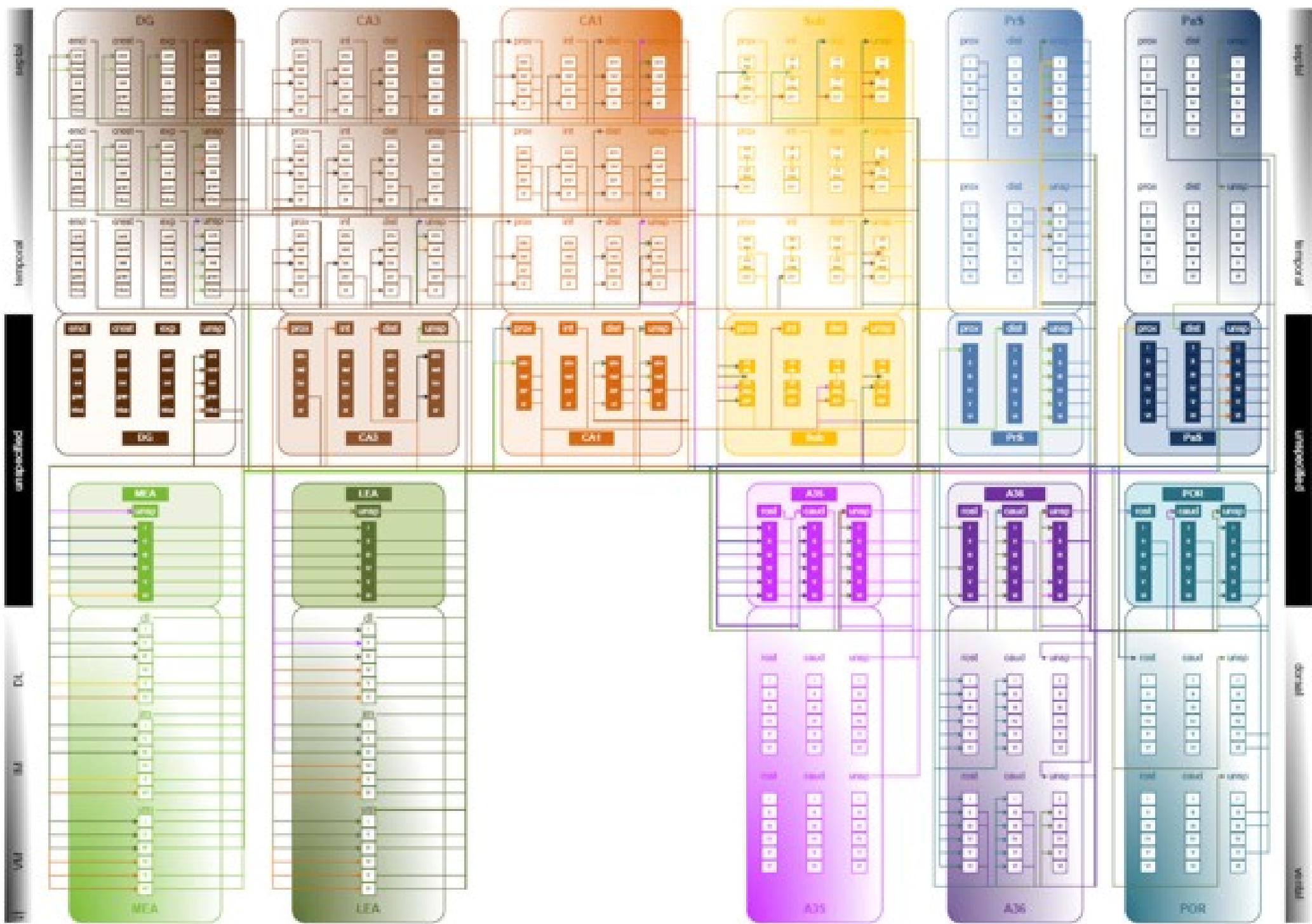

Some Numbers for the Rat

- Dentate Gyrus
 - 1.2 million granule cells
 - 4K basket cells
 - 32K hilar interneurons (20K mossy cells)
- CA3/CA1
 - 330K /420K pyramidal cells
 - various interneurons
- Entorhinal cortex layer II
 - Around 200K cells (20% interneurons?)
- Subiculum
 - Around 180K cells

Rat Connectivity

- Perforant path projection to DG
 - Around 4500 spines per granule cell (75% from EC)
 - One EC cells makes about 18,000 synapses with granule cells
- CA3: three distinct inputs
 - 50-80 mossy fibers from DG
 - 3,500 perforant path synapses from EC II
 - 12,000 recurrent collaterals from other CA3 cells
 - 8,000 to basilar dendrites (stratum oriens)
 - 4,000 to apical dendrites (stratum radiatum)
- CA1: inputs from CA3 and EC
 - From CA3 Schaffer collaterals: 4,500 basilar, 6500 apical synapses
 - From EC layer III: 2,500 synapses

Why Does the Circuitry Look Like This?

- Why so many kinds of interneurons?
- Why have recurrent connections in some regions and not others?
- What do these regions compute?

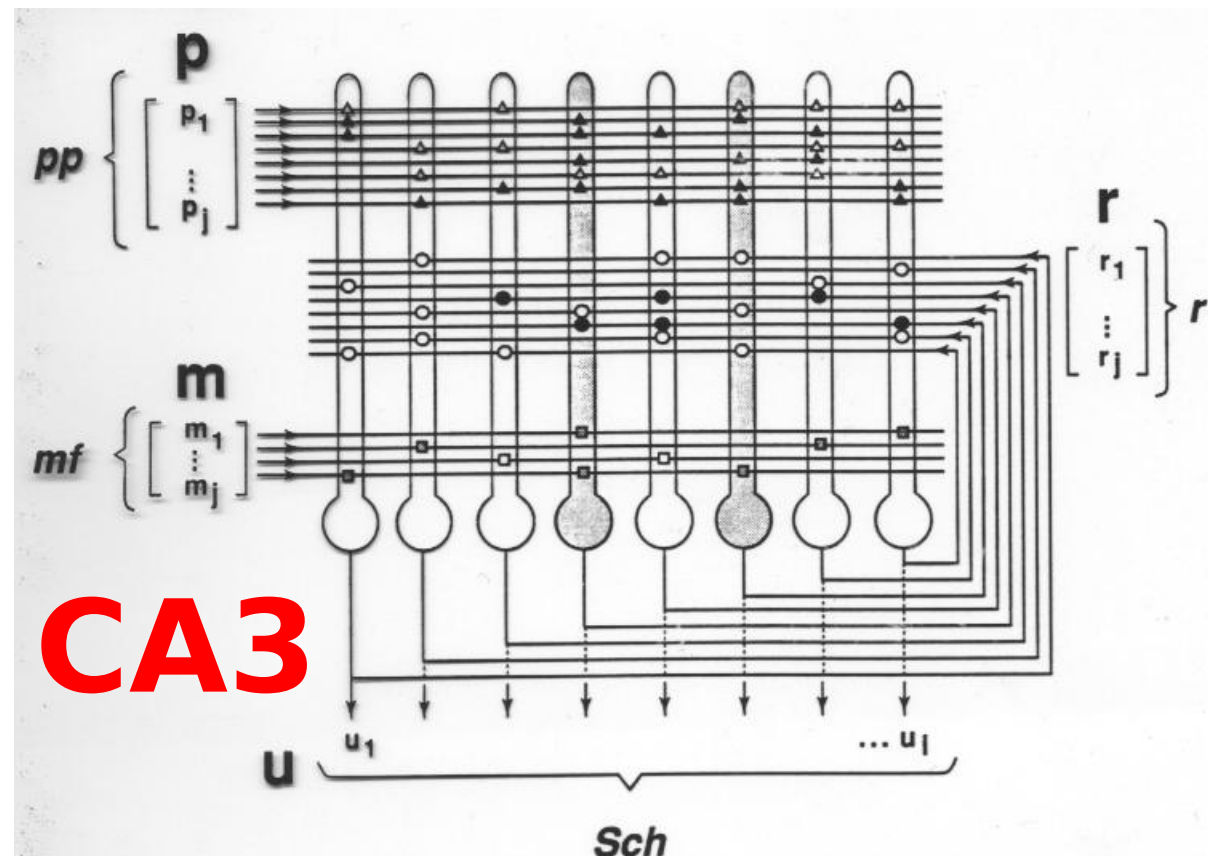

The Hippocampus Is Very Well Connected to Other Brain Areas

Connected via EC and fimbria-fornix pathway to:

- Prefrontal / orbitofrontal cortices
- Cingulate cortex
- Piriform cortex
- Perirhinal and Postrhinal cortices (sensory)
- Striatum
- Amygdala
- Septum
- Mammillary bodies
- Thalamus
- Hypothalamus

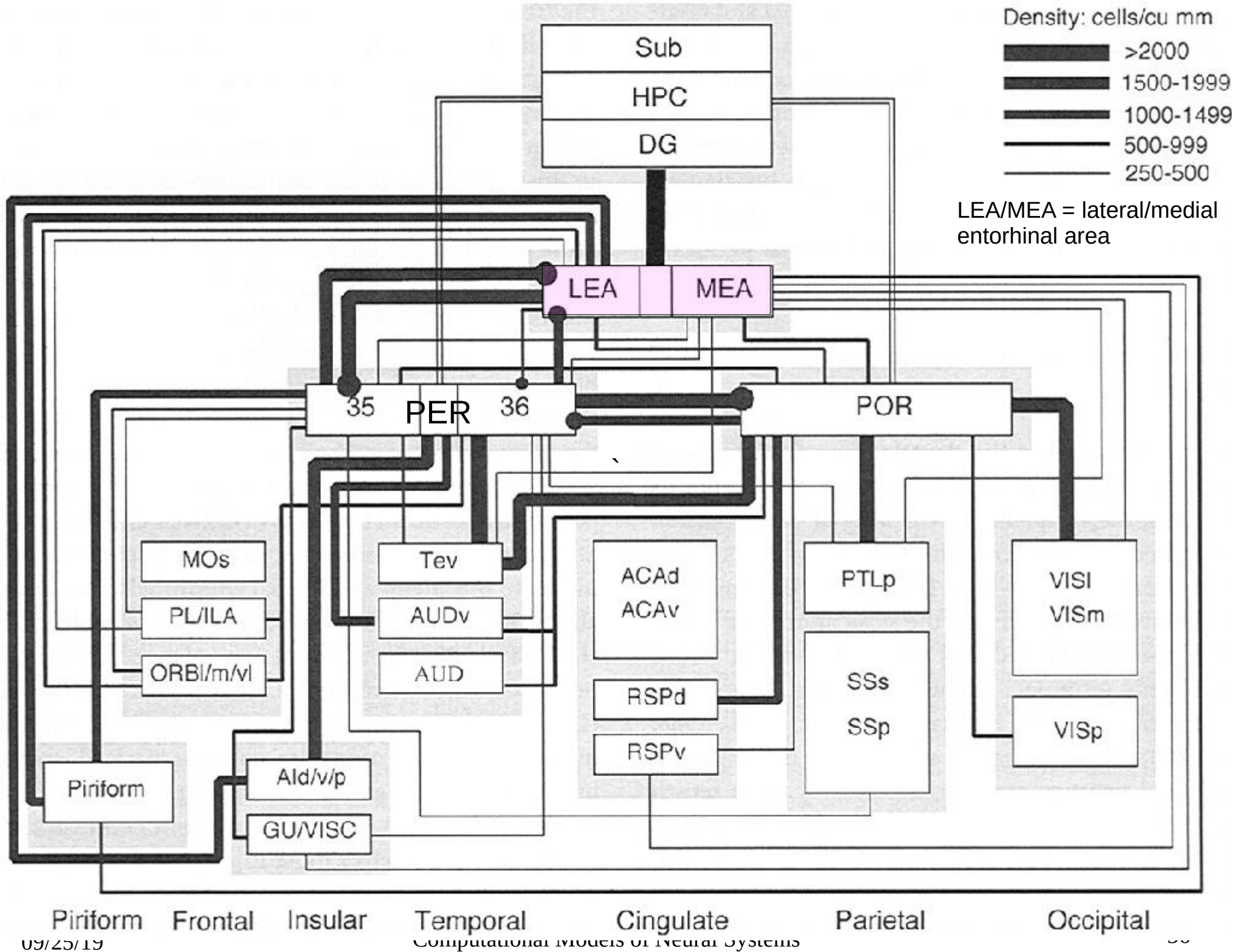

Neuromodulatory Projections to HC

Figure 3-21. Line drawing of horizontal sections through the rat hippocampal formation shows the distribution of A. noradrenergic, B. serotonergic, and C. dopaminergic fibers. (Source: Adapted from Swanson et al., 1987.)

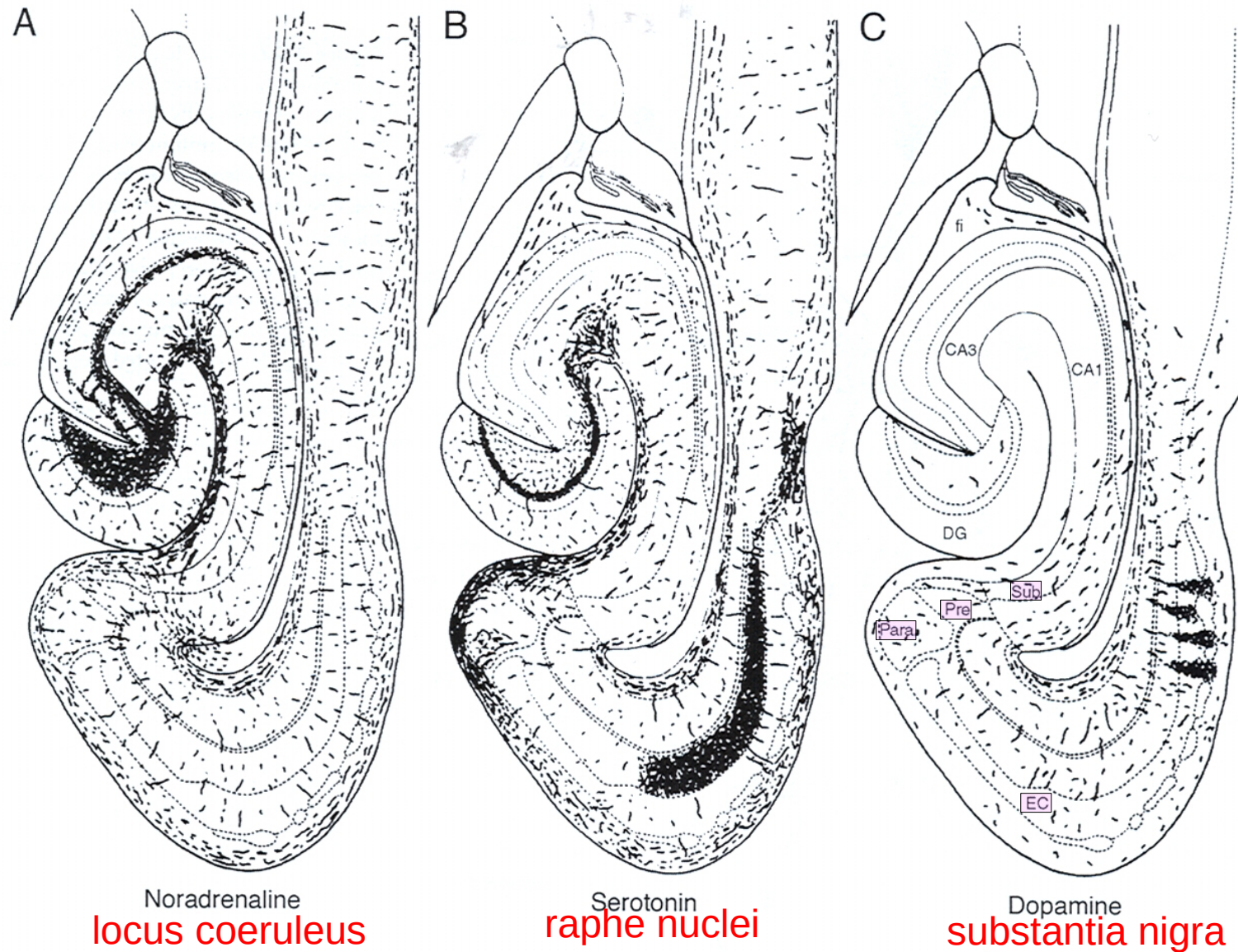

NA: Attention
5HT: Mood
DA: Reward
ACh: Novelty

acetylcholine
medial septum

Hippocampal EEG

- Awake
 - Active exploration:
 - theta (8-12 Hz) plus gamma (40 Hz)
 - Resting:
 - LIA (Large-amplitude Irregular Activity) w/transient sharp waves

- Asleep
 - REM sleep: theta
 - Slow wave sleep: LIA
 - S-SIA: small-amplitude irregular activity (Jarosiewicz & Skaggs)

Hippocampal EEG

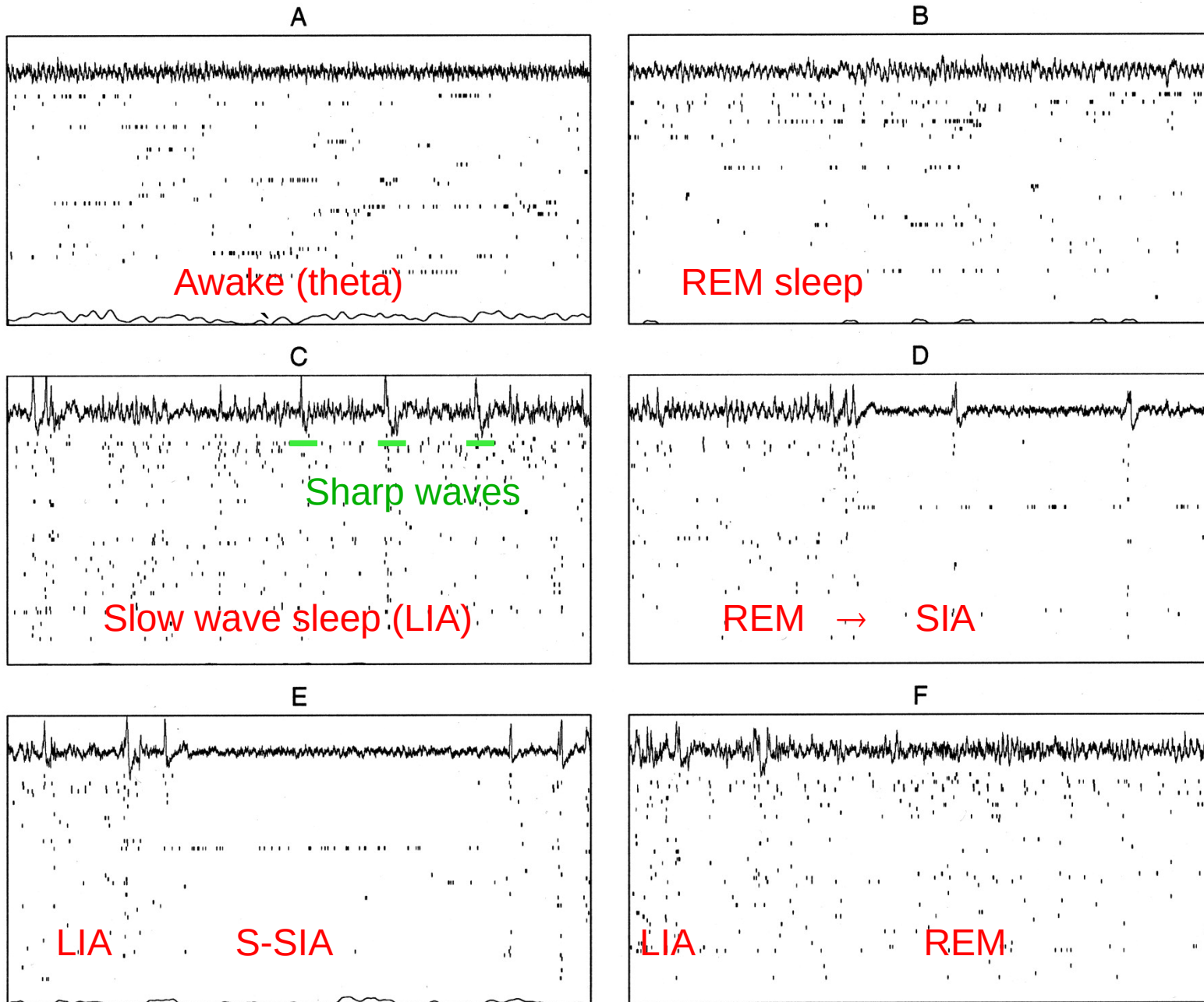

What Does the Hippocampus Do?

- Formation of new episodic memories?
 - Anterograde amnesia (H.M. and others)
- Cognitive map?
 - Place cells in rats; spatial attention cells in monkeys
- Configural association theory?
 - Lesioned rats are impaired on tasks requiring them to recognize cue configurations

A Hippocampal Prosthesis?

- Hampson et al (2013) Journal of Neural Engineering, 10(6).

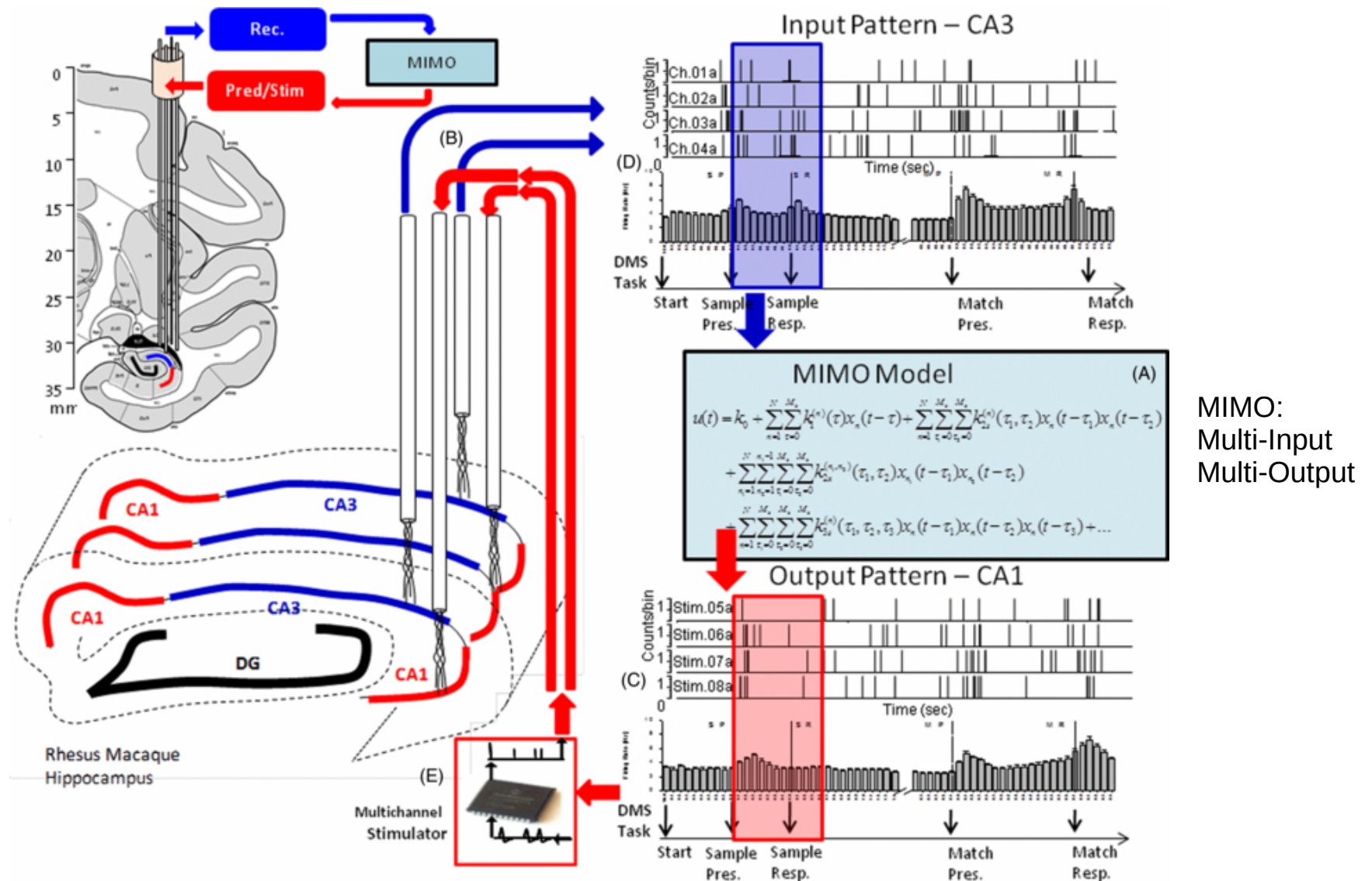

MIMO:
Multi-Input
Multi-Output

Delayed Match to Sample Task

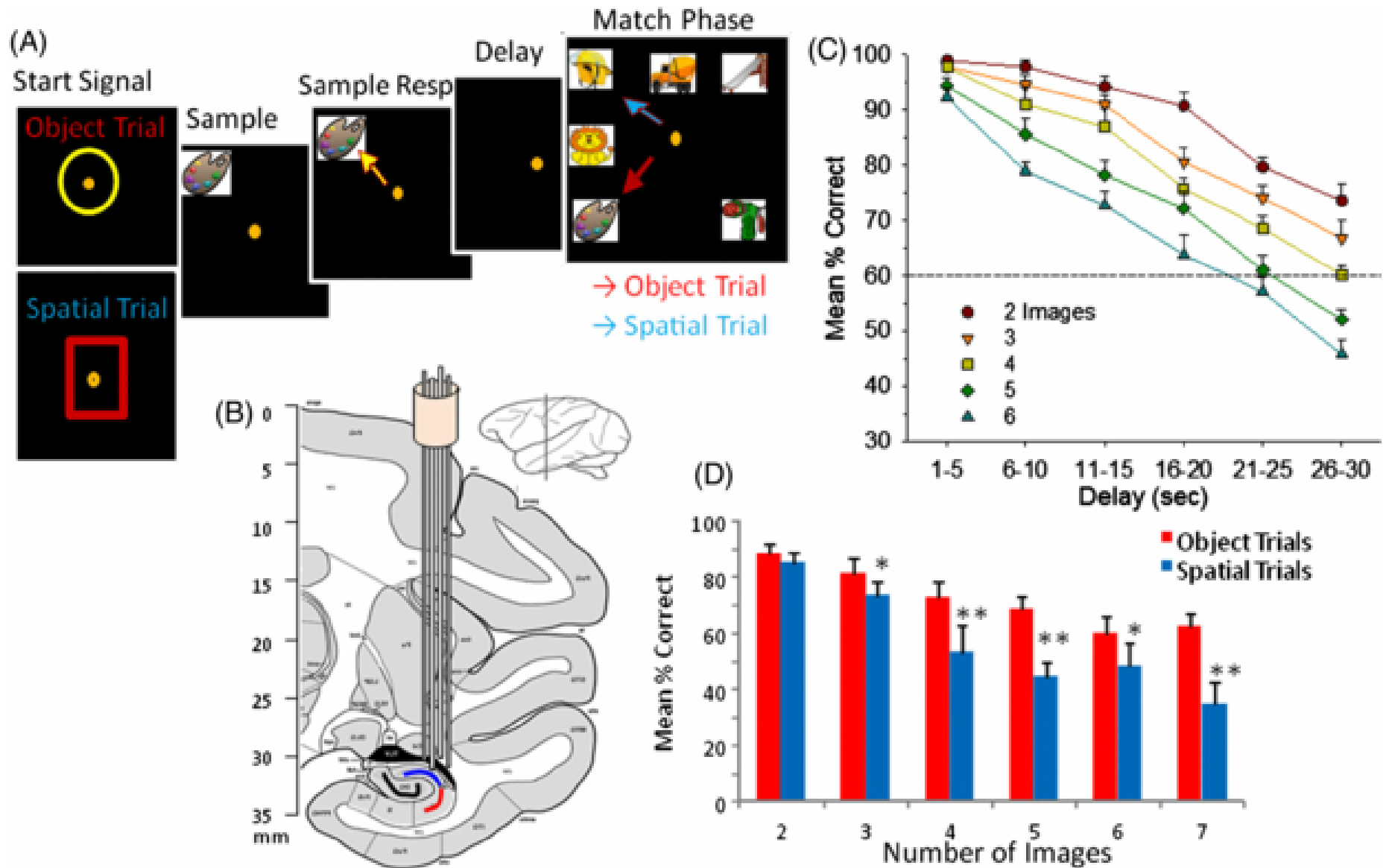

Effects of Stimulation

MIMO Stimulation of Hippocampus

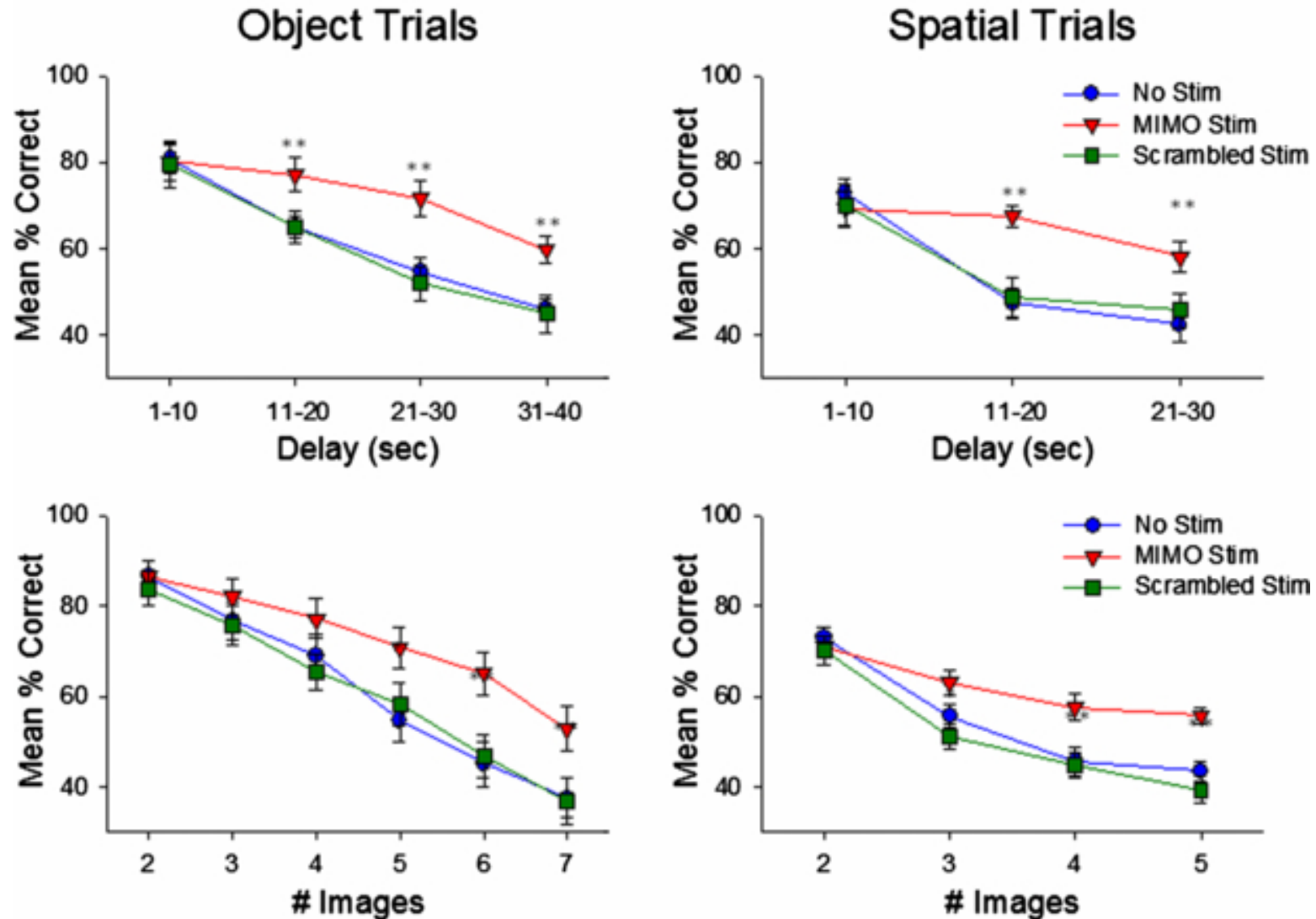

Results with Humans (2018)

Experiments done on epilepsy patients who had been implanted with electrodes to localize the source of their seizures.

Stimulation Effects within Memory Tasks

